

# ERKODENT Erich Kopp GmbH

ERKODENT has been founded in 1963 by the dentist and inventor Erich Kopp.

The company is engaged in the development, production and distribution of units and materials for the dental thermoforming technique, silicones, waxes and further products.

ERKODENT meets the standards  
DIN EN ISO 13485:2016  
ISO 9001:2015

ERKODENT  
Erich Kopp GmbH  
Siemensstraße 3  
72285 Pfalzgrafenweiler  
Germany  
[info@erkodent.com](mailto:info@erkodent.com)  
[www.erkodent.com](http://www.erkodent.com)



Pfalzgrafenweiler

France

Switzerland

# Dental thermoforming technique



# Thermoforming

Thermoforming is the adaptation of a plastic foil that has been plastified by heating.

There are two different working principles of thermoforming units:

Vacuum  
with an open working area during thermoforming

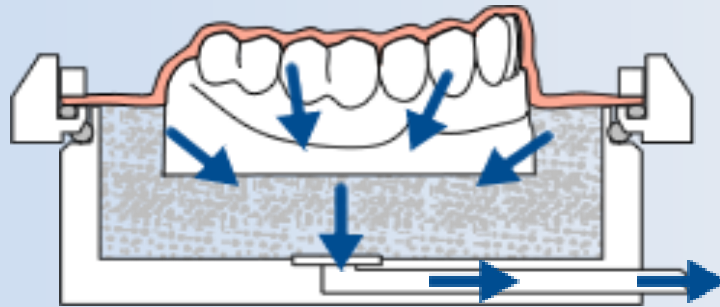
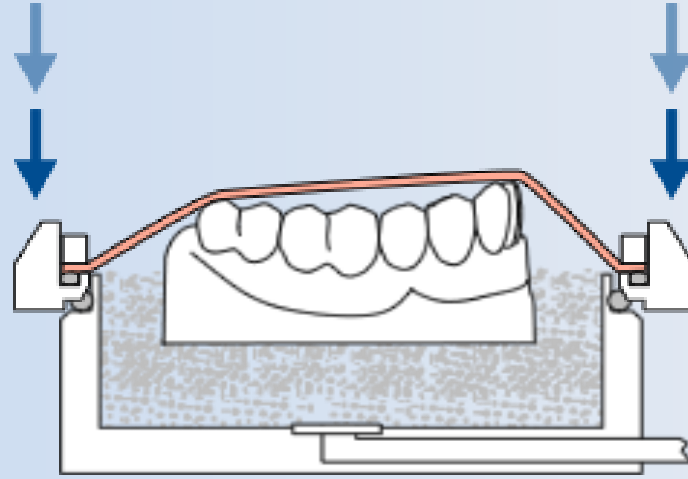

**Vacuum:**  
The material is pulled onto the model.  
The sudden vacuum ensures good results.



## Thermoforming

Pressure  
with a closed working area  
during thermoforming.

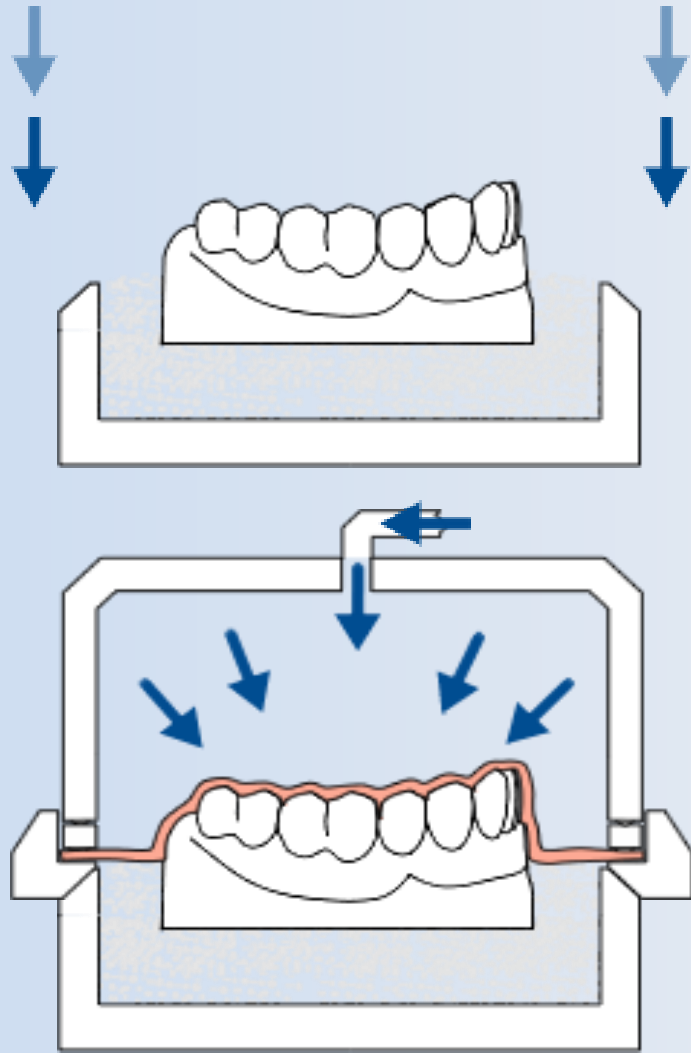
**Pressure:**

The material is pressed onto the model.  
If the pressure is high enough the adaptation always  
provides good results.



# The proportions of material thickness

During thermoforming the plastified thermoforming material will be stretched. This leads to a thinning of the material with effects on the wall thickness.

1 cm thermoforming height corresponds to a loss in material thickness of approx. 25 %. (1)

In the plane occlusal surface (for ex. molar teeth) the thickness is largely maintained whereas laterally the material thins out. (2)

The incisal area with a small surface (for ex. anterior teeth) the distribution of the thickness is inversely. (3)

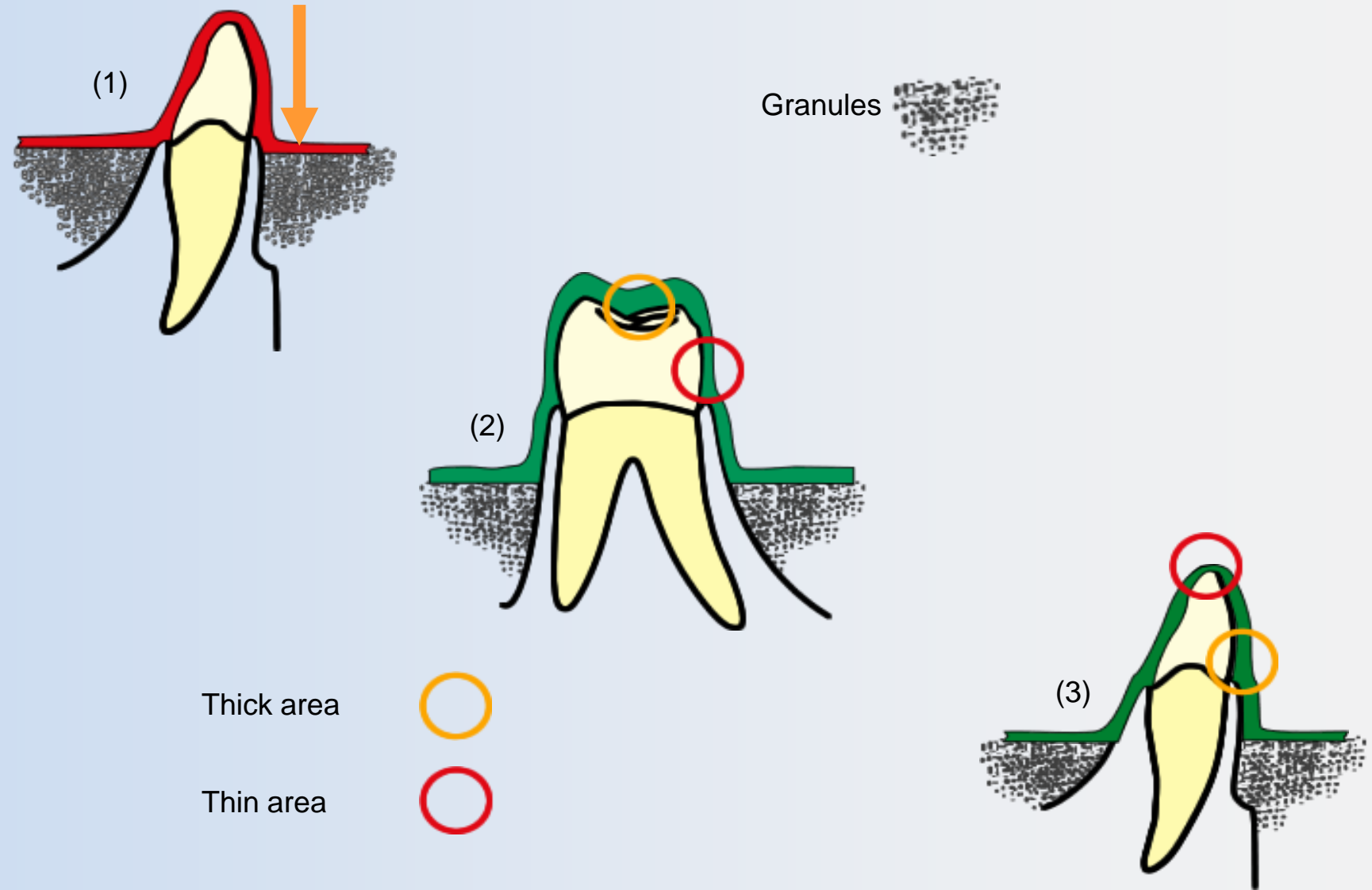

# How can the material thickness be influenced?

The alignment of the models to the adaptation movement influences the material thickness.

Vestibularly declined models (1) show thicker palatal areas whereas palatinally declined models (2) have thicker vestibular areas.

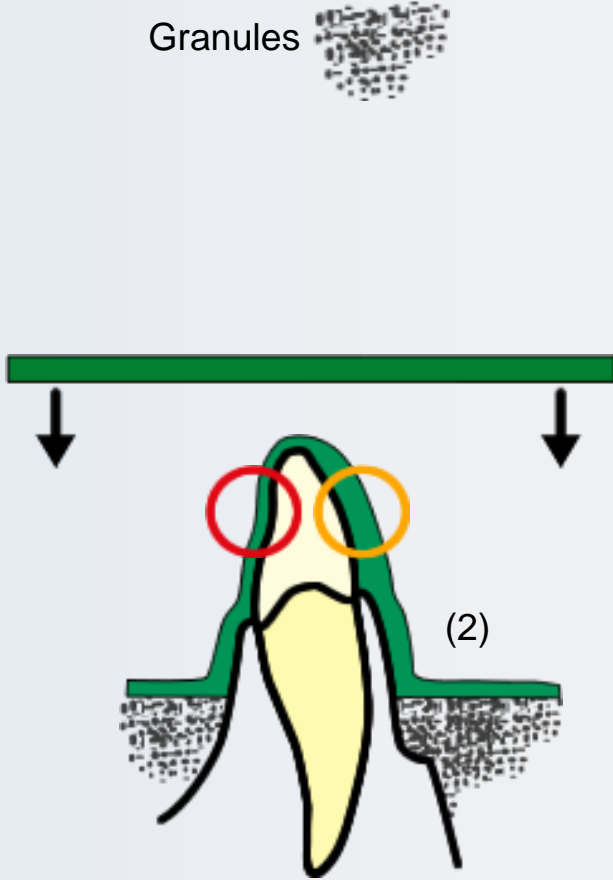
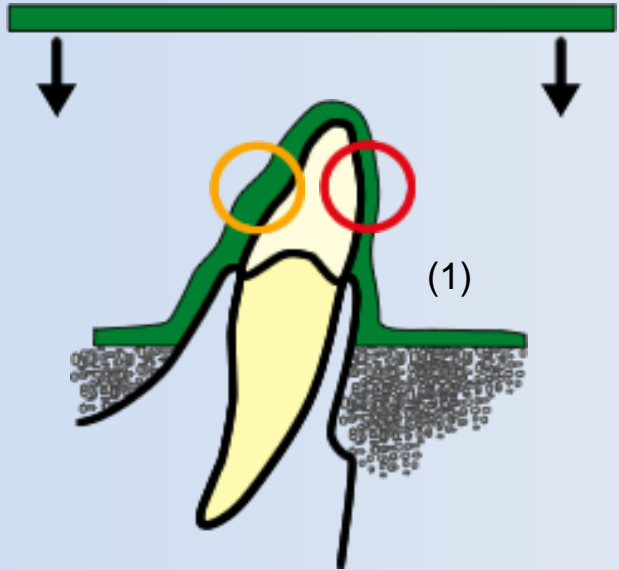

Thick area 

Thin area 

# What is the effect of the adaptation direction?

All Erkodent thermoforming units have a vertical adaptation.

Why?

The vertical adaptation of the foils ensures even material thicknesses.

A not vertical adaptation for ex. the folding of the heating area for the adaptation leads to unequal material thicknesses by sagging of the hot, plastic material during folding.

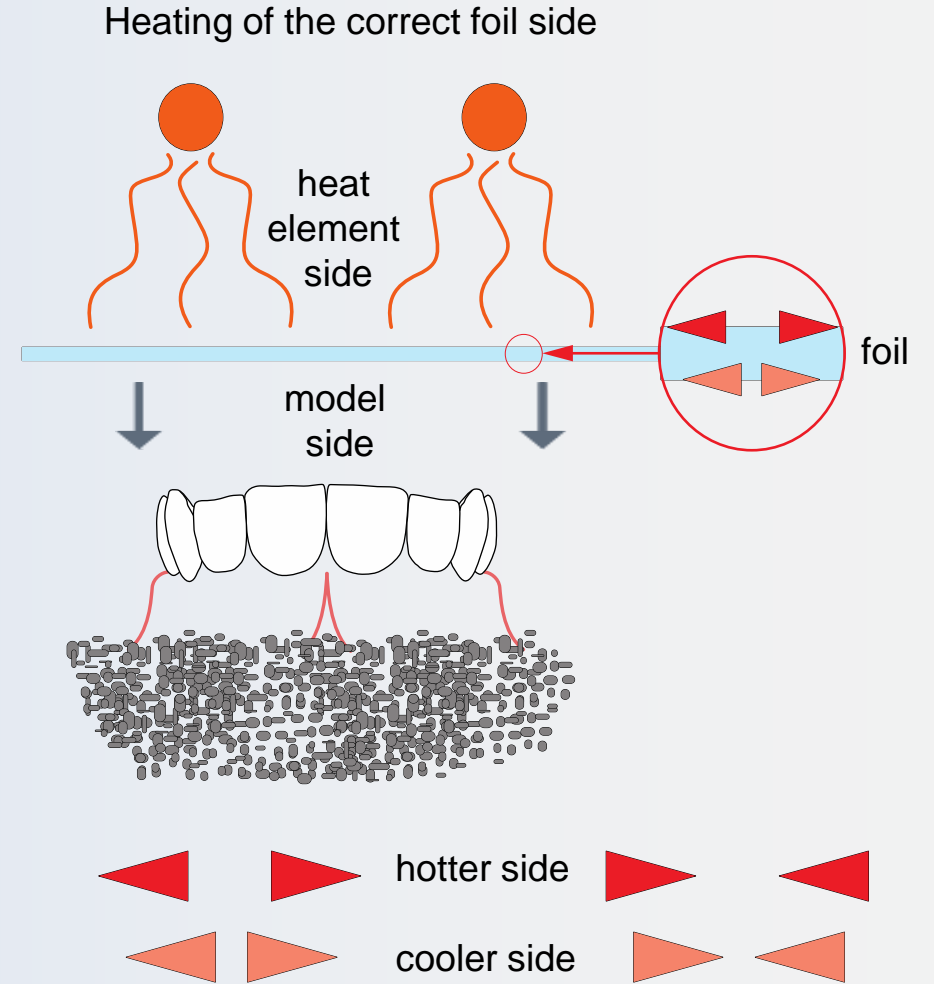
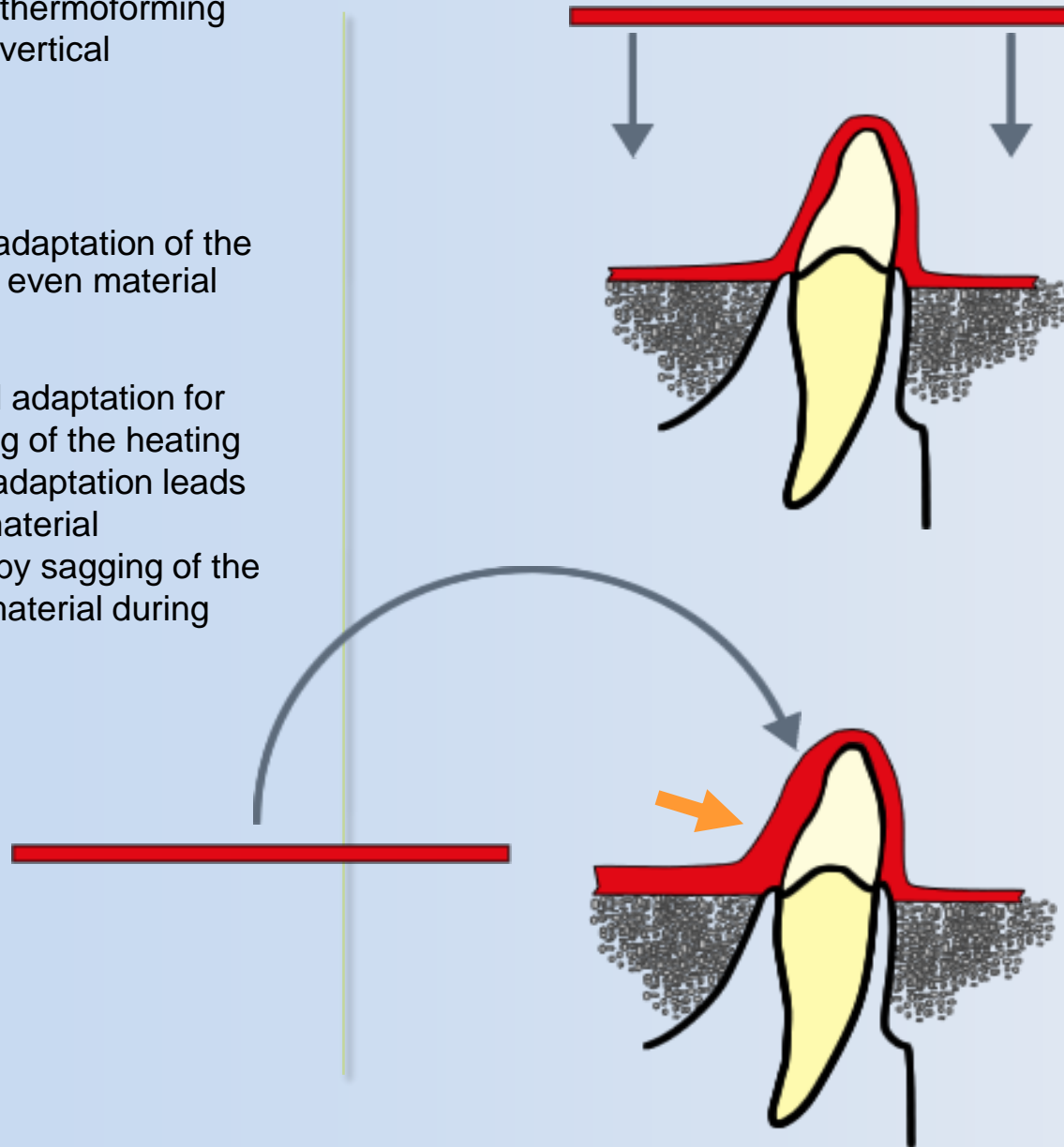

The foil side pointing towards the heating gets hotter. The hotter side expands more and shrinks more during cooling. Is the heat element side heated thicker splints will sit with less tension in the mouth.

## ERKODENT thermoforming units

Erkoform-3d +  
Erkoform-3d*motion*

Ultra rapid vacuum forming unit (>0,7) with touchless temperature sensor for accurate determination of the actual thermoforming material temperature.



Erkopress \_\_*motion*

Universal pressure unit, working pressure up to 6 bar.

Erkopress ci *motion*  
with integrated compressor.

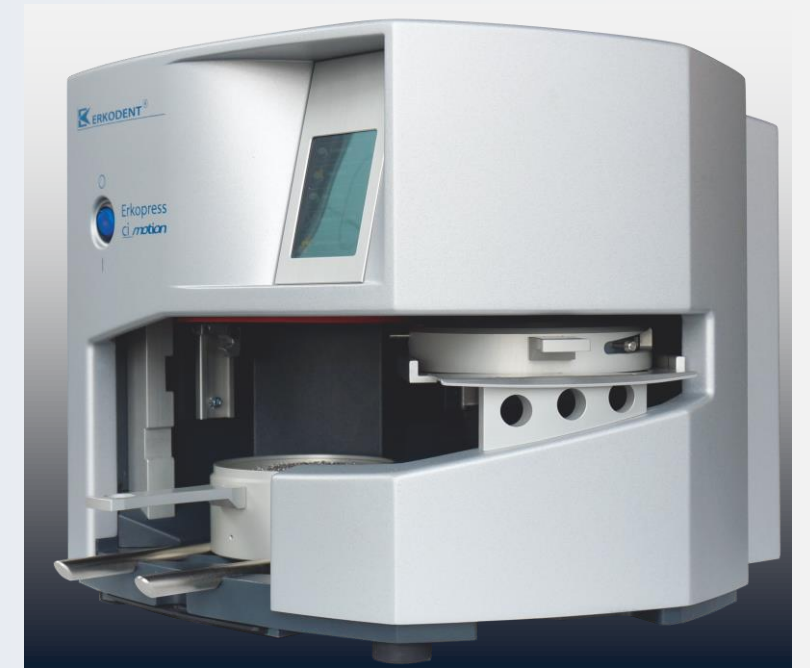



## Erkoform-3d*motion*

The Erkoform-3d*motion* is the quintessence of the Erkodent vacuum units.

All characteristics of the proven and continuously improved Erkoform-3d/3d+ are available plus an unmatched operating comfort by the automated thermoforming process.

- No compressed-air supply required
- No preheating time
- Touchless temperature sensor for accurate determination of the foil temperature
- Sudden vacuum built up before thermoforming process.
- Perpendicular prestretching
- Acoustic and optic signal, therefore also suitable for deaf persons.



- Program foil
- Insert foil
- Start heating process, now place the model in the unit. Time for other, everything else will be carried out by the Erkoform-3d*motion* !
- The thermoforming process and the cooling time run automatically
- Acoustic and optic signal, therefore also suitable for deaf persons

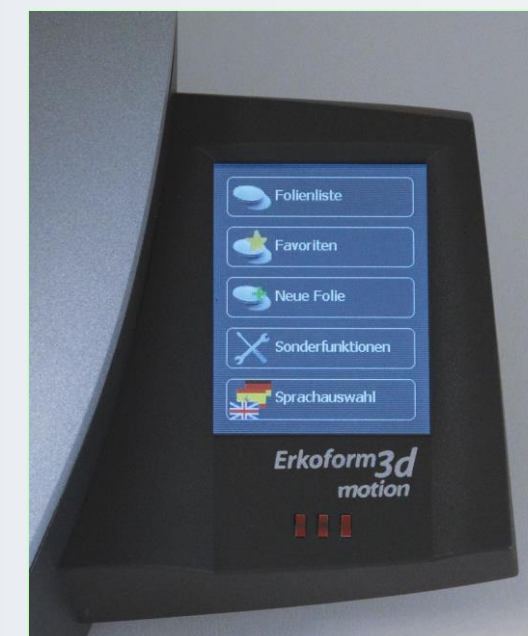

## Erkoform-3d+

- Same characteristics as the Erkoform-3d*motion* but without automated thermoforming process.

Touchpanel (-3d*motion* / 3d+ with partly different functions)

- The program contains all Erkodent thermoforming materials, leads with animations through the sequence of work and indicates the required working steps.

- Select desired foil and thickness, start.

- The display informs about each operating status.

- The indicated thermoforming temperature and cooling time can be changed for special applications without influencing the basic program.



- Often used foils can be saved as favorites.

- New foils can be programmed as favorites.

- Also changed factory settings can be saved as favorites.

- Special functions allow to separately turn the heating and vacuum pump on and off.

- Safety switch-off after 10 sec. when the next working steps are not executed.

- Many different languages can be selected.

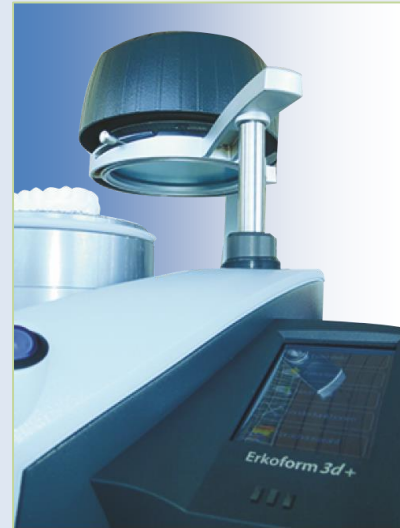

## Erkopress *ci motion*

### Erkopress *\_\_ motion*



Erkopress *\_\_ motion*, pressure forming unit with unmatched operating comfort by the automated thermoforming process.

- Touchless temperature sensor for the accurate determination of the actual thermoforming material temperature.
- Vertical forming without delay for even foil thicknesses.
- Touchpanel to call up the desired foil and the necessary working steps.
- Up to 6 bar working pressure.

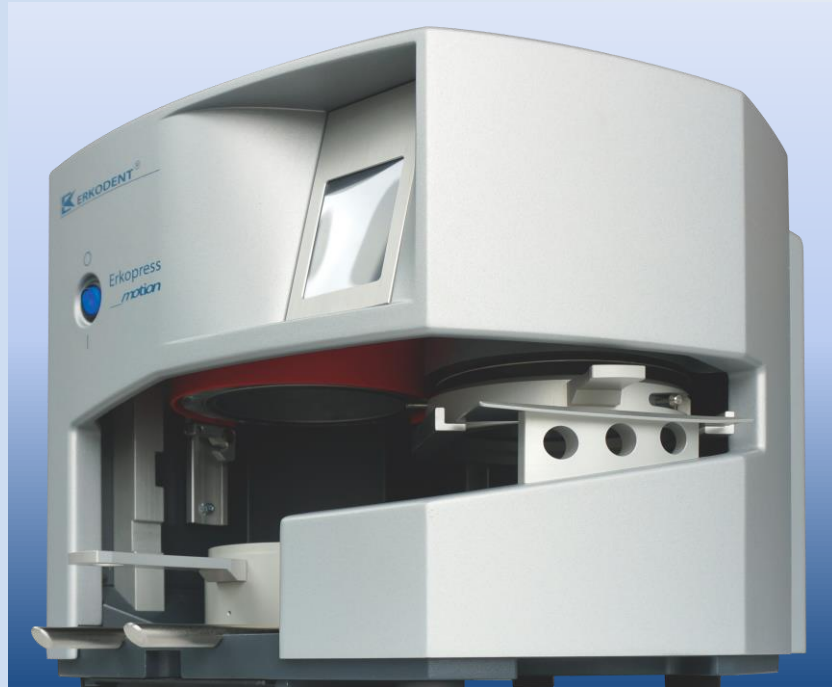

Erkopress *ci motion*, pressure forming unit with the same features as Erkopress *\_\_ motion*, but independent of a compressed air system. The unit is equipped with an integrated powerful compressor with reserve compressed-air (pat. 19518211).

The alternative to the Erkopress *\_\_ motion*, wherever a costly compressed-air installation would be necessary.

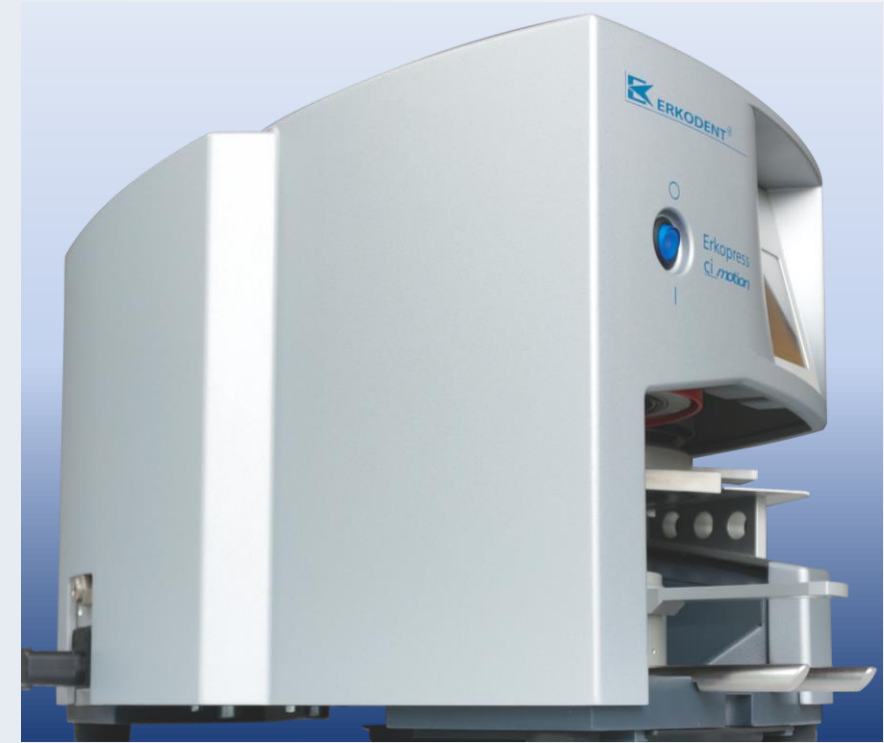

## Occluform-3

Occluform-3 is a unique occludator for the Erkoform-3d+ and Erkoform-3d*motion* units.

The Occluform-3 allows to imprint the opposing bite during the thermoforming process in the thermoforming material which is in that moment perfectly formable.



# Occluform-3

The construction of the Occluform-3 device is based on a Bonwill triangle with a side length of 11.5 cm and a Balkwill angle of 20°.

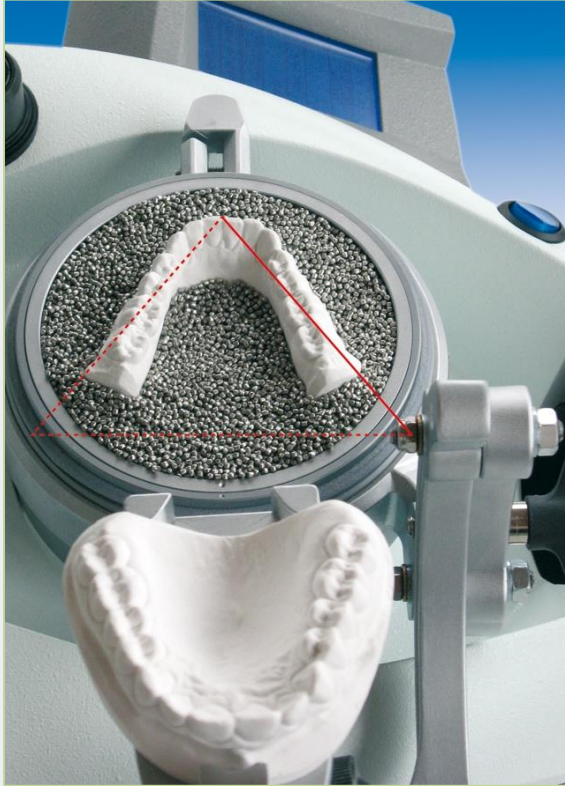
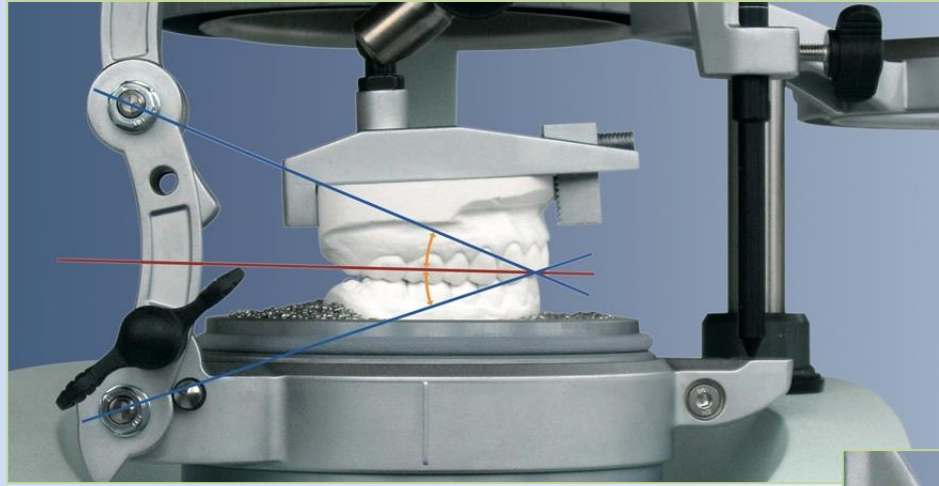

# Occluform-3

With a construction bite the Occluform-3 can be adjusted precisely.

If no construction bite is available the Occluform-3 allows a median bite elevation.

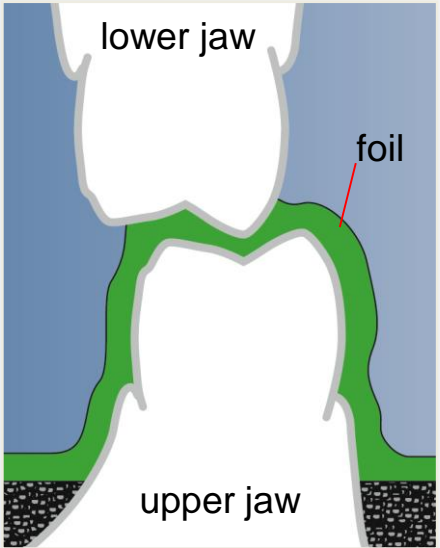

## Thermoforming materials

ERKODENT provides the right foil for all applications in dental thermoforming.

All thermoforming materials are physiologically harmless, they are all listed at the health authority.

Allergic reactions are improbable but cannot be excluded.

The materials are CE marked and meet the requirements of the EC regulation:

DIN EN ISO 13485:2010 /  
ISO 9001:2008

medical products class 1.

The available material card contains order numbers, samples to touch as well as informations about material characteristics and field of use.



### Tested biological safety:



#### Evaluation

Sponsor	Erkodent Erich Kopp GmbH, Mr. Wolfgang Heuchert, Siemensstraße 3, 72285 Pfalzgrafenweiler
Date of order	13-01-10
Evaluation	Biological safety - toxicology (EN ISO 10993-1, Directive 93/42/EEC)
Documentation	Presented by the sponsor.
Expert	Dr. Madlon Timme
Notes	This evaluation refers only to the documentation presented by the sponsor. Confidential - for exclusive use of the sponsor and registration authorities. Reproduction except in full only with the written approval of Medical Device Services.

Device/Material	ERKOLOC-Pro [1, 2].
Manufacturer	Erkodent Erich Kopp GmbH [1, 2]
Intended use	Double-layer plate hard/soft for the manufacturing of dental splints, e.g. occlusal and bruxism splints and anti-snoring devices, by means of thermoforming technique, single patient device [1-3].
Body contact	Direct and indirect (saliva-mediated) with oral mucosa and hard tooth tissue, < 24 h, repeated application (> 30 days) [1].
Surface area	< 30 cm <sup>2</sup> (patient-contacting) [1].
EN ISO 10993-1	Biological effects to be considered for leachables are cytotoxicity, sensitization, mucosa/tissue irritation, systemic toxicity, and genotoxicity.

# Applications

The unit that is best suited for the following applications is highlighted in green.

If no unit is highlighted the units are to be considered as equivalent.

If a unit is not listed it is not suitable or reasonable.

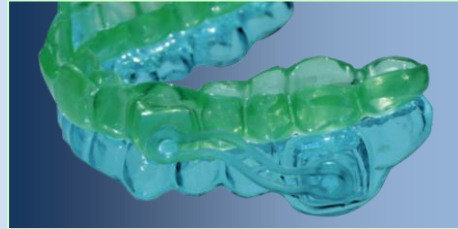

Silensor-sl  
Erkopress 300 Tp/300 Tp-ci

Erkoform-3d*motion*/3d+  
and Occluform-3



Playsafe sports mouthguard  
Erkopress 300 Tp/300 Tp-ci

Erkoform-3d*motion*/3d+  
and Occluform-3



Adjusted occlusal splint  
Erkopress 300 Tp/300 Tp-ci

Erkoform-3d*motion*/3d+  
and Occluform-3



Temporary appliance  
Erkopress 300 Tp/300 Tp-ci

Erkoform-3d*motion*/3d+



Individual impression tray  
Erkopress 300 Tp/300 Tp-ci

Erkoform-3d*motion*/3d+  
and PLA-Griff



Bleaching tray  
Erkopress 300 Tp/300 Tp-ci

Erkoform-3d*motion*/3d+





# Applications

The unit that is best suited for the following applications is highlighted in green.

If no unit is highlighted the units are to be considered as equivalent.

If a unit is not listed it is not suitable or reasonable.

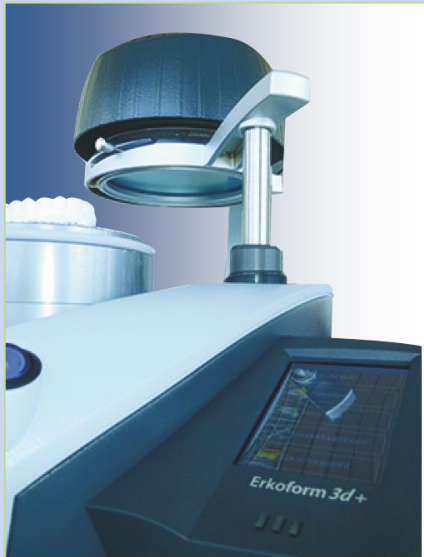

Copings

Erkopress 300 Tp/300 Tp-ci

Erkoform-3d*motion*/3d+\*

\* Only with ex works applied insulating foil



Stabilization splint

Erkopress 300 Tp/300 Tp-ci

Erkoform-3d*motion*/3d+

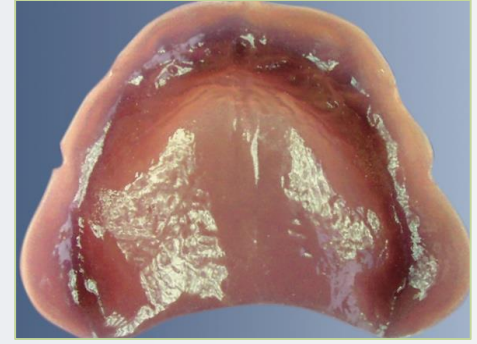

Denture base

Erkopress 300 Tp/300 Tp-ci

Erkoform-3d*motion*/3d+



Cosmetical splints

Erkopress 300 Tp/300 Tp-ci

Erkoform-3d*motion*/3d+  
and Occluform-3

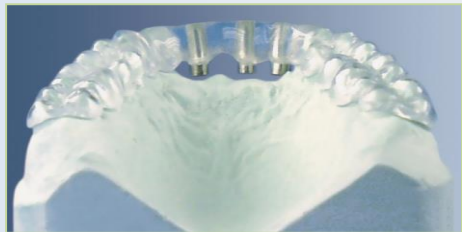

Drilling templates

Erkopress 300 Tp/300 Tp-ci

Erkoform-3d*motion*/3d+  
and Occluform-3



Fluoride trays

Erkopress 300 Tp/300 Tp-ci

Erkoform-3d*motion*/3d+

# Applications (Orthodontics)

The unit that is best suited for the following applications is highlighted in green.

If no unit is highlighted the units are to be considered as equivalent.

If a unit is not listed it is not suitable or reasonable.

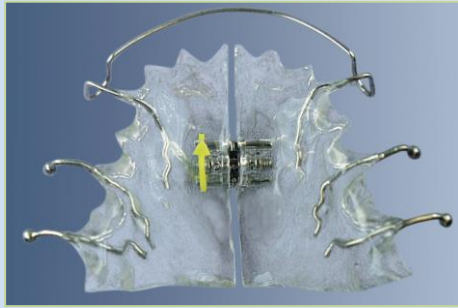

Extension plates

Erkopress 300 Tp/300 Tp-ci



Bracket transfer splint

Erkopress 300 Tp/300 Tp-ci  
Erkoform-3d*motion*/3d+



Correction splints (Aligner)

Erkopress 300 Tp/300 Tp-ci  
Erkoform-3d*motion*/3d+



Extension plates\*  
\*different way of fabrication

Erkoform-3d*motion*/3d+



Positioner

Erkopress 300 Tp/300 Tp-ci

Erkoform-3d*motion*/3d+  
and Occluform-3



Etching mask for brackets

Erkopress 300 Tp/300 Tp-ci

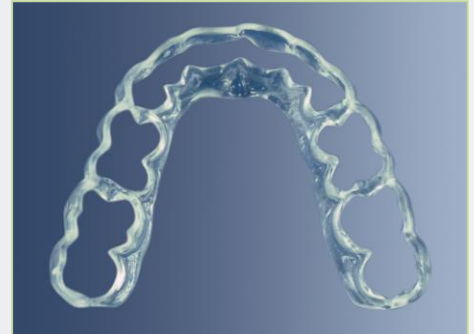

Retainer

Erkopress 300 Tp/300 Tp-ci

Erkoform-3d*motion*/3d+  
and Occluform-3

# Aligners (correction splints)

Restoring force of aligning splints.

Comparison test of the restoring force of the recommended Erkodent foil for Aligners over a period of 12 hours.

Bend  
2,3 mm



The flatter the graph, the less loss of the restoring force.  
The material with the flattest graph keeps the restoring force for the longest time.

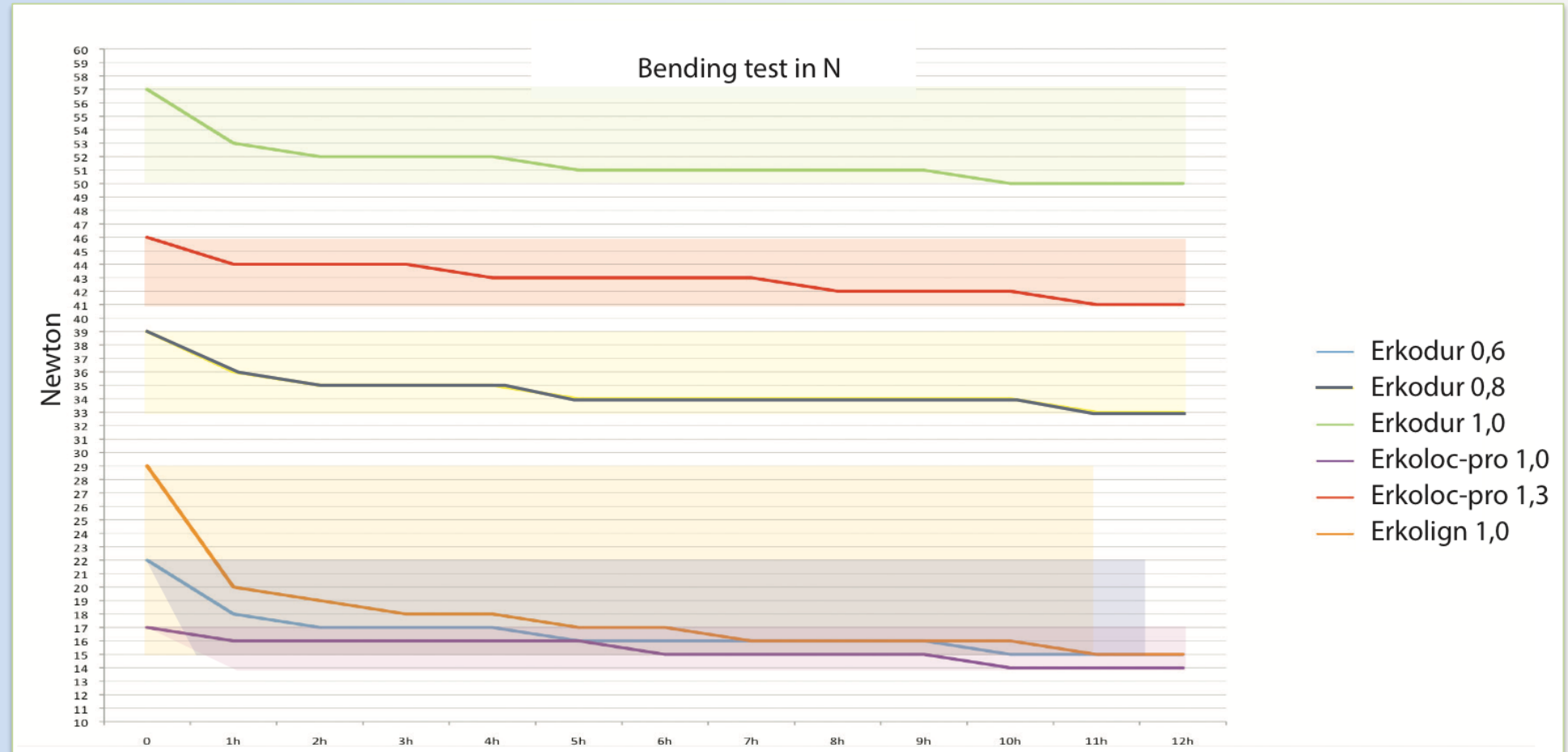

## Maintenance of thermoformed appliances



Oxydens tablets and  
Oxydens Clean-set:

- remove plaque and mineral deposits
- remove smells
- fresh and clean splints
- prevent discoloring
- practical Oxydens Clean-set for hygienic use and storage



### Oxydens

An intensively tested cleansing system for all dental splints that are fabricated with the Erkodent thermoforming technique.

bruxism splints,

Playsafe sports mouthguards,

Silensor-sl anti-snoring devices,

orthodontic appliances,

correction splints,

retainers,

dentures and similar.



# Model preparation

Models have to be fabricated out of stone (class 3). The stone must not be wet, it may contain residual moisture or be dry.

The model undercuts have to be blocked out (Erkogum) and negative plaster bubbles have to be filled with high-fusing wax.

If areas that are sensitive to pressure are touched by the appliance an additional spacer should be applied at this area on the model (Erkoskin).



reusable blocking out material Erkogum  
110 844 transparent  
110 847 lilac



high fusing wax  
725 080 transparent  
725 055 lilac

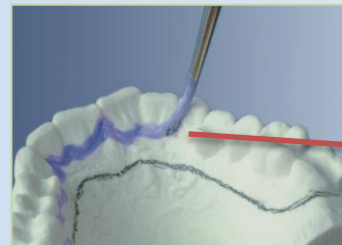

liquid spacer Erkoskin  
625 050

Erkogum

wax

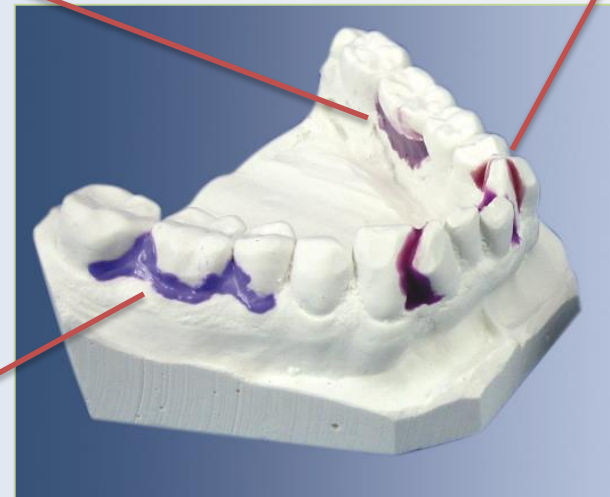

Erkoskin

# Finishing

The finishing set Quick 3 contains all rotating instruments that are useful for the finishing of all thermoforming materials:

- Fissure bur with rough cutting.
- HSS twist drill for more precise contours.
- Tungsten carbide bur for smoothing.
- Liskosil-l/-m/-s for prepolishing, one of each.

Finishing set Quick 3  
Order no.: 110 830

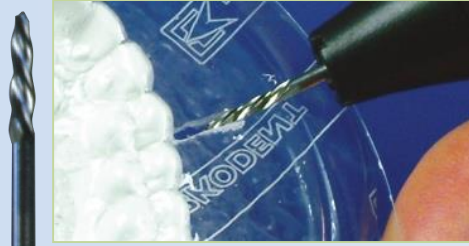

Fissure bur with left spiral for rough cutting.



HSS twist drill for precise cutting of hard and semi-hard materials.



Crosscut conical tungsten carbide bur for grinding all thermoforming materials.

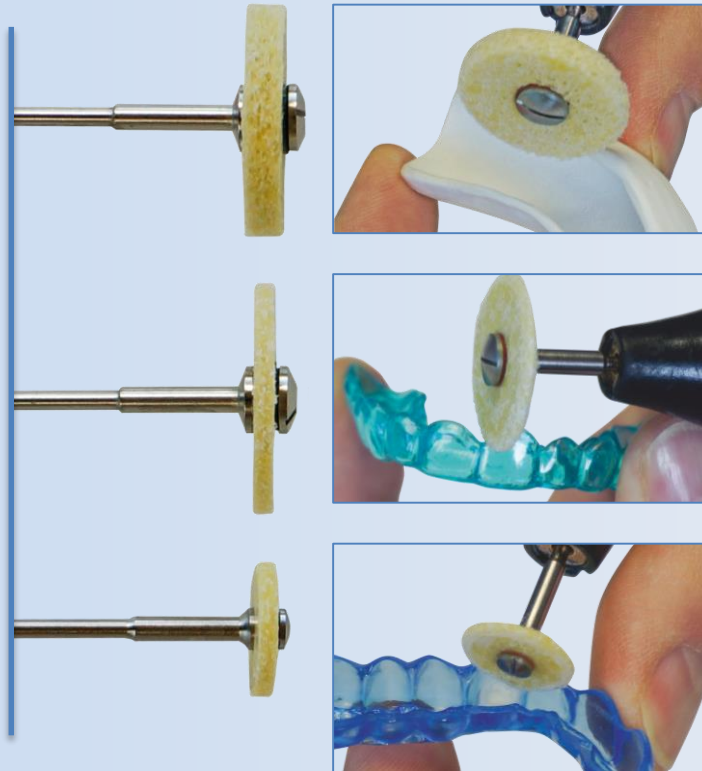

Liskosil-l, is particularly useful for treating larger areas. Larger amounts of material can be removed without leaving an edged surface behind.

(Ø 27 mm, 4 mm thickness)

Liskosil-m, is for narrow/confined areas, e.g. in the papilla area of a splint, where it allows for the same result as with Liskosil-l.

(Ø 27 mm, 2 mm thickness)

Liskosil-s, the small diameter allows for treatment of occlusal premature contacts and even the inside of a splint. (Ø 27 mm, 4 mm thickness)

## Finishing

Hard plastics are polished to a high gloss with a polishing mass for plastics. Either with the polishing lathe or with the handpiece and the polishing set (110 878).

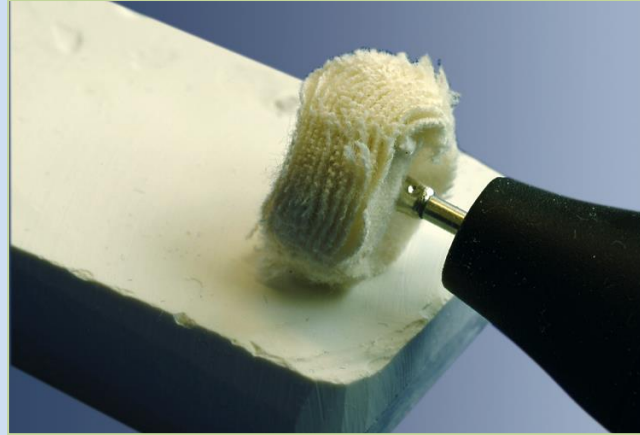

High gloss finish of hard plastics with the handpiece and the ERKODENT polishing set.

Soft, elastic plastics are shined with the hot air burner (177 540).

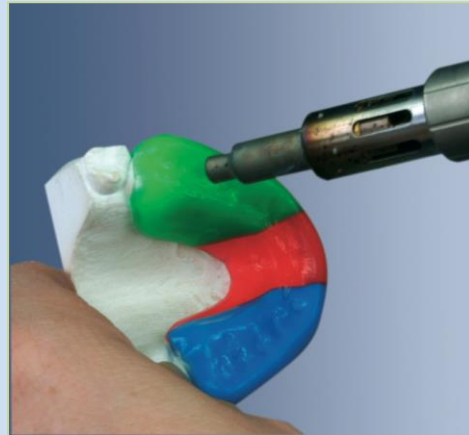

Shining with the hot air burner.

## Fabrication

The fabrication of the different appliances is described in details in the thermoforming technique manual. This can also be downloaded from [www.erkodent.com](http://www.erkodent.com).

Thank you very much for your attention.





# Splint therapy Bruxism

Adjusted occlusal splints



## Splint therapy

Thermoformed adjusted occlusal splints with the Occluform-3 and Erkoform-3 units

The Occluform-3 can be adjusted with a construction bite.

The adjustment during the thermoforming procedure with the Occluform-3 allows to manufacture complex adjusted splints in an unbeatably quick and material friendly way.



# Splint therapy

Brief description of the most important splint designs:

The very individual concepts in splint therapy of functional diseases of the chewing apparatus (TMD, Temporomandibular-Disorder/CMD, Cranio-Mandibular-Disorder) caused a huge number of different splint designs.

Therefore only the main design groups will be briefly described:



**Reflexing splint** (for ex. interceptor, aqualizer (pict.), flat foil splint): These splints interrupt the parafunctions (neuro muscular reflex) and are manufactured for the upper and lower jaw.

In most cases a thermoforming foil of 1.0 - 2.0 mm is formed over a plaster model. Such a splint has to be adjusted in the mouth or the opposing bite is imprinted with the Occluform-3.

Advantage, good result at acute pain and parafunctions. Very helpful as a pretherapy for the manufacturing of a centric splint to allow the ability of centric for the registration.

Disadvantage, no safe positioning of the condyles and no safe guidance.



**Excentric splints** (repositioning splint, distraction or decompression splint):

**Repositioning splint:** These splints take the lower jaw into an anterior/ anterior-caudal position. They replace the displaced condyles.

Repositioning splints are due to the high relapse not in the Guidelines of the American Association of Orofacial Pain.

**Distraction splint:** These splints are used when the condyles are displaced without a repositioning need. The distraction or decompression splint shows in the molar area a pre-contact (hypomochlion). During the contraction of the chewing muscles this activates a distraction/decompression of the joint capsule. However, newer studies could not confirm that distraction or decompression splints have advantages compared to centric splints. But they show more unwelcome side effects.



## Splint therapy



### **Centric splint** (Michigan, relaxation, equilibration and bite raising splints):

These splints relax the neuro muscular tension and reproduce the physiological joint position. The adjustment places the condyles into the centric and avoids excentric precontacts (canina guidance).

In most cases the centric splints are made for the upper jaw.

The main condition for centric splints is the registration in the physiological condyle position. To do this many different technical, electronical and manual procedures can be used.

To allow the ability of centric for the registration, relaxing exercises (cotton rolls), physio therapy and/or a treatment with reflex splints might be necessary.

Centric splints are suitable for most TMD diseases and very helpful if major bite corrections are planned.

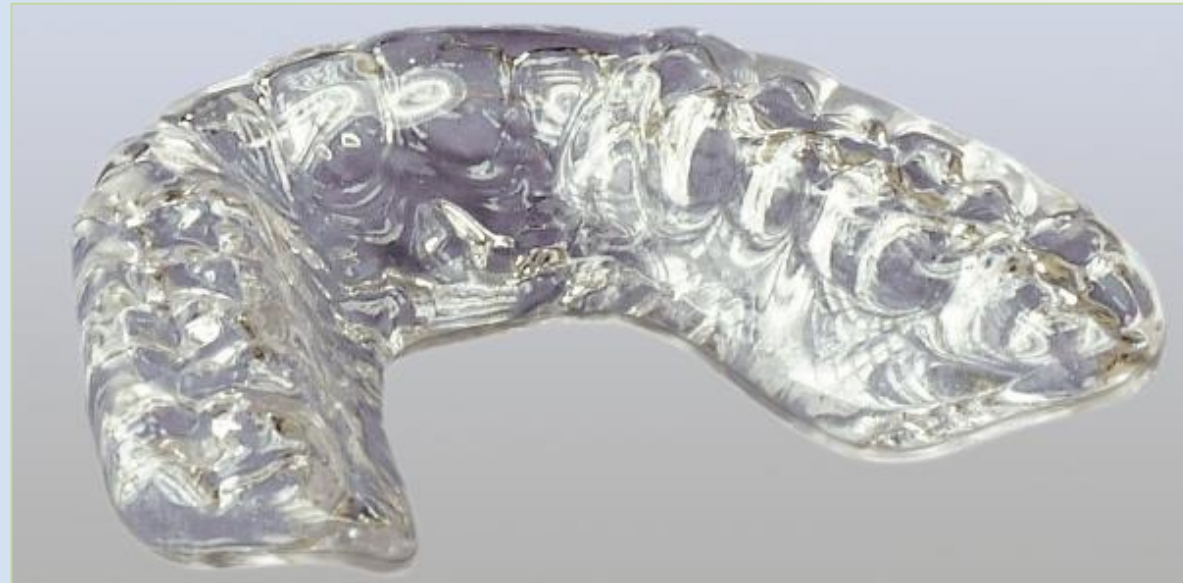

## Splint therapy

This recommendable publication of Dr. Bernd Schwan (ZMK 7-8/99) gives an overview of the different TMD's and the corresponding splint therapy:

The **centric splints** are suitable for all TMD's mentioned in this chart

Disease	Main symptoms (options)	Diagnostic possibilities	Therapeutic approaches (only regarded splint therapy)
myalgi/ myogelosis/ myohypertrophy	pains in the area of the musc. mas.; functional restrictions (possibly deviation, possibly stomata↓)	clinical examination, manual diagnostics	centric splints, reflex splints
abrasion/wedge-shaped defects	abrasion/wedge-shaped defects; enamel defects	clinical examination	centric splints, reflex splints
capsule and ligament affection	pains in the joint ares, functional restrictions, joint noises ("lateral ligament snap")	clinical examination, manual diagnostics	centric splints, reflex splints
micro trauma	joint noises (initial or intermediate snap, possibly reziprok), functional restrictions, pains	clinical examination, axiographie, MRT to exclude a makro trauma	remodelation of fillings, removal of rough occlusal disorders, centric splint
partial discus dystopia with reposition	joint noises (mostly inital reziprok snap), functional restrictions, deflection), pains	clinical examination, manual diagnostics, Achsiographie, MRT, Sonographie	repositioning splint or centric splint
total discus dystopia with reposition	joint noises (inital or intermediate reziprok snap), functional restrictions, deflection, pains	clinical examination, manual diagnostics, axiography, MRT, sonography	repositioning splint or centric splint
discus dystopia without reposition	limitation of the stomata, pains in the joint area, no noises („silent joint"), deviation possible	clinical examination, manual diagnostics, Achsiographie, MRT	centric splint, distraction splint
arthropatia deformans	joint noises (rubbing), pains in the joint area, possibly limitation or deviation, creation of osteophytes of the condyle in the OPG	clinical examination, X-ray	centric splints, reflex splints

# Splint therapy

Manufacturing of a centric splint (Michigan) with:

- Erkoloc-pro/Erkodur
- Erkoform-3/3d
- Occluform-3 technique.



For the fabrication of an adjusted occlusal splint the model only has to protrude of the model pot by height of the teeth plus 3 mm.



Place the registration onto the model in the form pot. Articulate the models according to this registration. That way the imprint corresponds exactly to the bite registration.

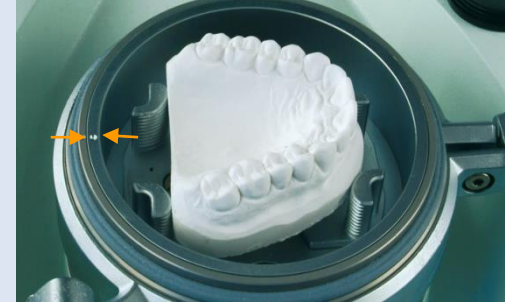

Put the model pot that way into the unit that the markings (arrows) are opposite.



Hold the upper model plate in position and firmly close the arrest joint.

Open the Occluform.



Fix the antagonistic jaw onto the upper model plate. Prefix the model in a preferably high position with the arrest joint.

Close the Occluform.

## Splint therapy

## Manufacturing



Fill as many high grade steel granules in the pot that only the thermoforming area plus 3 mm are visible. Ensure that also the hollow spaces under the model are filled with granules.



Condense and smooth granules.



Insulate the opposing bite (Isolac).



Now it can be thermoformed. **Immediately** after adaptation close the Occluform until the supporting pin gets contact.



After the thermoforming material has cooled down open the Occluform. The imprint corresponds to the bite elevation or the construction bite.

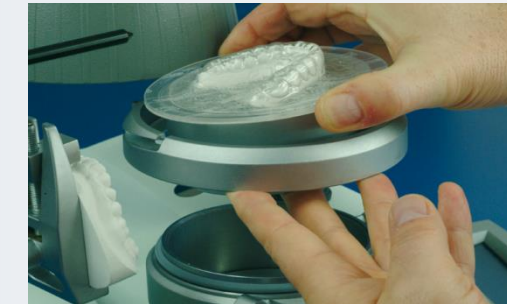

Open the foil securing ring, lift the foil frame of the unit together with the model pot and take off the foil frame with the foil.

# Splint therapy

## Finishing of the thermoformed splint of each thickness



Cut in the thermoformed plate with The fissure bur (> 20 000 rev./min.) for an easier removal of the model.



Use the twist drill HSS without pressure (> 20 000 rev./min.) to cut out the final shape.



If necessary, grind the edges with the crosscut tungsten carbide bur (> 20 000 rev./min.).

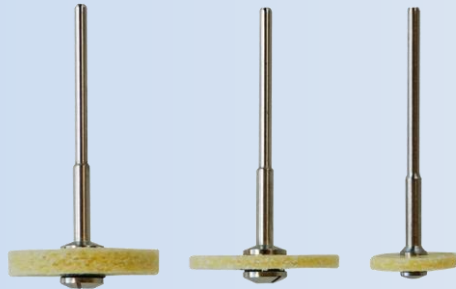

Smooth the edges with Liskosil-I/-m/-s (10 000 rev./min.).



Polish the matt areas with the polishing set using a lab handpiece.

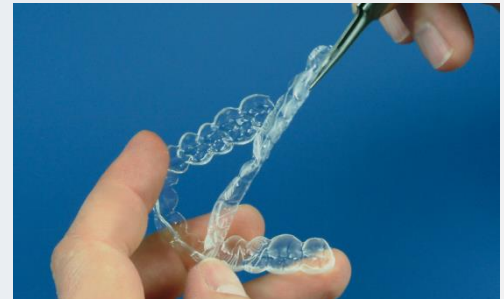

It would be best to now take off the insulating foil.

Has the splint to be adjusted by addition, only cut out the shape roughly.



# Splint therapy

Manufacturing of a canina guidance **by addition** (autoacrylic, Resilit-S)



Brush areas that have to be adjusted with an autopolymer resin (Resilit-S) with little monomer.



Insulate the opposing bite (Isolac), put the splint back on the model, apply the mixed Resilit-S...



... and brush the plate with monomer. Put the models in the articulator.



Close the articulator and cure in the polymerisation pot at 40 - 50 °C. After curing open the articulator carefully (model may break!) and remove the splint.



Finish the area that has been adjusted by addition and the splint.



Finished Michigan splint.

## Splint therapy

Manufacturing of a canina guidance **without addition**.

Should the canina guidance be ground in by reduction thick thermoforming material (4.0 - 5.0 mm) and the Occluform-3 technique has to be applied.

Hot thermoforming material can be formed manually to provide enough material in the area for a canina guidance which has to be ground in afterwards.



Take the bite with the Occluform...



...and immediately press the hot plastic foil material in the cuspid area with a suitable instrument against the antagonistic jaw.



Pushed up areas to grind in the canina guidance.



Centric splint with canina guidance (Michigan splint) completely made from the thermoforming material (Erkoloc-pro/Erkodur).

# Splint therapy

The grinding in:



The grinding-in of thermoformed splints is not different compared to splints made from other resins.



Typically only the lowest parts of the antagonistic cuspid tips form the contact areas.

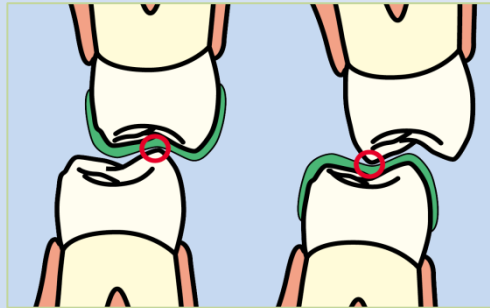

To a splint for the upper jaw only the carrying cuspids of the lower jaw have contact and contrariwise. The areas around these contacts are shaped according to the rules of freedom in centric.



Thank you very much for your attention.

Sleep disorders  
... dentistry?



# Sleep disorders ... dentistry?

Snoring and the obstructive sleep apnea (OSA), the interruption of the respiration during the sleep, belong to the most common sleep disorders.

In western industrialized countries approx. 10 % of the 20 years old men and 50 % of the 50 years old men snore. Women come up to two third of these data.

These sleep disorders can be successfully treated or at least be positively influenced in dentistry.



open respiratory tracts

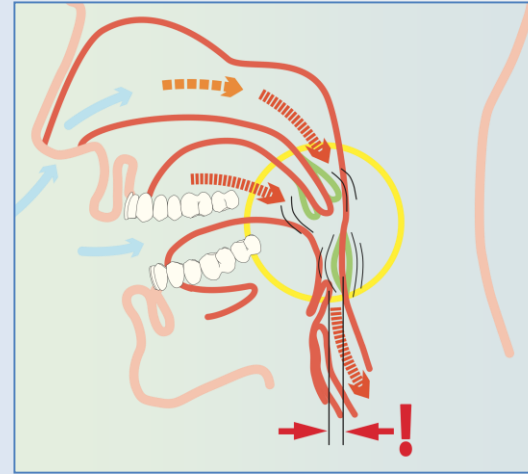

narrowed respiratory tracts:  
snoring

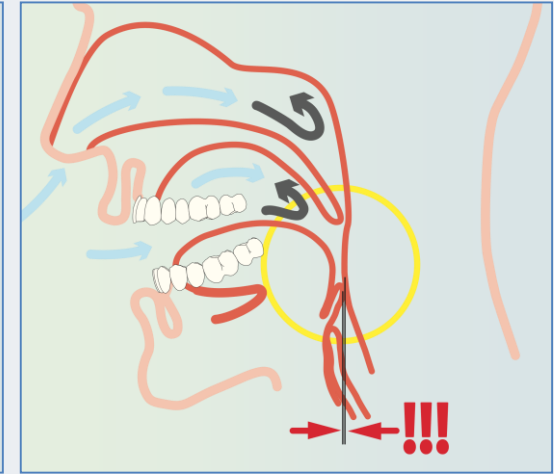

collapsed respiratory tracts:  
obstructive sleep apnea (OSA)

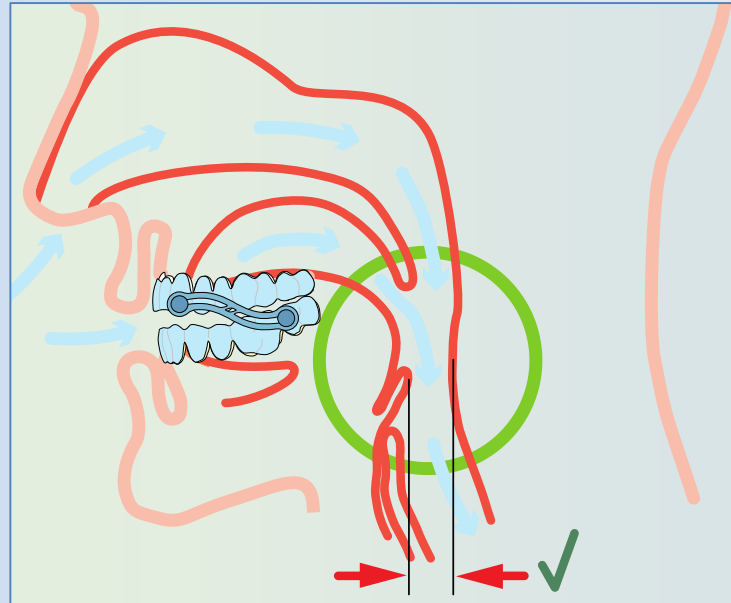

open respiratory tracts: Silensor-sl,  
mandibular advancement splint



Some illustrations of this presentation originate from publications and advertising materials of different authors, manufacturers and distributors. These illustrations must not be used without permission.

## Topics of this lecture

1. Sleep disorders

2. Apnea during sleep

3. Therapy:

1. NCPAP (Nasal Continuous Positive Airways Pressure)

1. Surgery

2. Oral appliances

1. Tongue retainer

2. Protrusion splints (MAS, mandibular advancement splint) splints that advance the lower jaw

Terms on somnology:

primary snoring → light snoring

rhonchopathy → upper airway resistance syndrom (UARS) = obstructive snoring

Apnea → pauses in breathing

obstructive apnea → relocation of the upper respiratory tract

central apnea → stoppage of the respiration reflex

Hypopnea → air flow reduced by more than 50 %

AHI → apnea/hypopnea index

RDI → respiratory disturbance index = disorder of the respiration

arousal → reaction of awakening (no waking state)

somnography → examination of the sleep quality

SBAS → sleep-related breathing disorder

Silensor-sl



# Sleep disorders

## External sleep disorders

Disturbance of the sleep quality by external reasons, noise, bad bed, bad room air etc.

noise:



bed quality:



bruxism:



snoring and sleep position:



## Internal sleep disorders

Disturbance of the sleep quality by internal reasons, teeth grinding (bruxism), indigestive food, medicaments, drugs, snoring, sleep apnea, pain and other diseases.

sleep apnea:

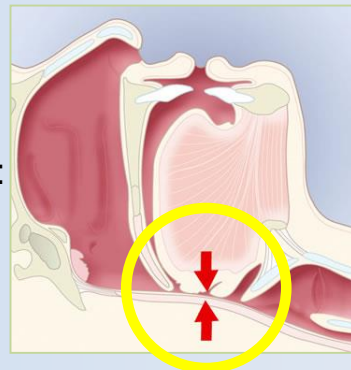

rich meal:



drugs etc.:



... and other diseases

# Snoring

Snoring is generated in the upper respiratory tract.

By the decreasing of the muscle tone during sleep the lower jaw falls backwards.

The result is a narrowing of the respiratory tract.

The air flow will be accelerated and soft tissue (velum, uvula and other) start to vibrate and cause the snoring noise.

open pharynx,  
no noise

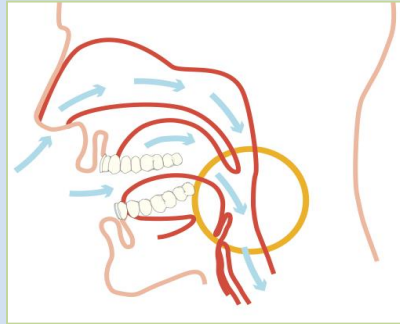

narrowed pharynx,  
accelerated air flow at the same air volume,  
noise caused by fluttering, vibrating structures

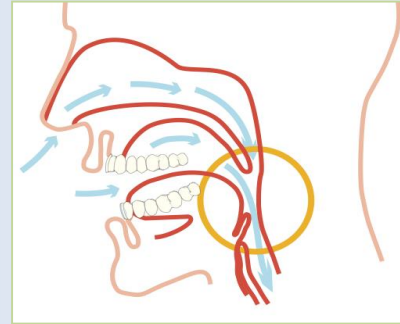

Snoring is a mechanical process that can be counteracted mechanically. This is where the dental therapy comes into action.

Contrary to the rhonchopathy, the abnormal snoring, the light or primary snoring does not have a negative influence on the cardiovascular system and the oxygen supply.

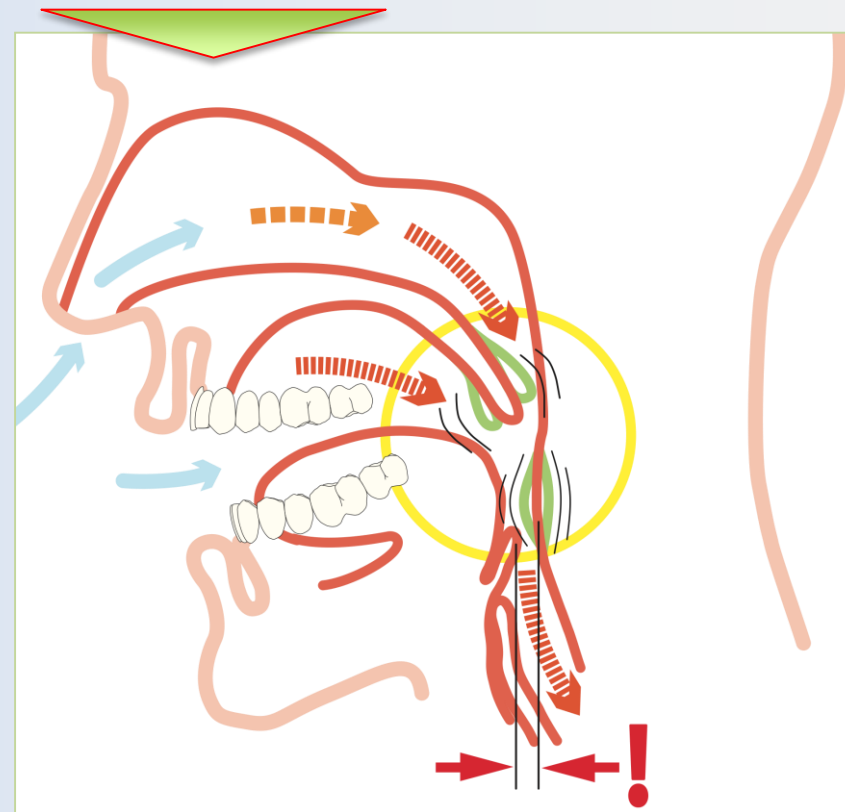



# Snoring

## → Abnormal snoring:

Rhonchopathy, obstructive snoring, snoring with airway resistance. Upper airway resistance syndrom (UARS)

## → Primary snoring:

Snoring harmless to health

abnormal snoring:		harmless, primary snoring:
frequency snoring every night	————	frequency snoring from time to time
loudness of snoring very loud, audible in the next room	————	loudness of snoring, moderately loud to loud, harmonious
sound explosive, hard, with high frequency, stertorous	————	sound low frequency
respiration irregular, possibly with pauses (breaks)	————	respiration regular, without pauses
sleep patterns restless sleep, frequent awakenings	————	sleep patterns quiet sleep

## Commercial offers against primary snoring

On the market there are numerous devices against snoring available.

In case of very light snoring a success might be achieved but some products are rather questionable.

These auxiliaries are available to anyone but cannot always be considered as being harmless.



Auxiliaries to avoid a dorsal position.



Nostril spreader, the reason for snoring, however, is mostly in the pharyngeal area.



Pillow Silensor (Canada), let the head tilt to the side.

(This pillow is the reason why the Erkodent Silensor is called Silent Nite in North America.)



nose inserts for stimulation



acupressure ring

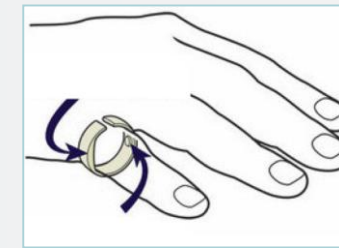

spray to „grease“ the mucosa

spray to stiffen the velum by foaming



## The apnea and hypopnea

The apnea is a complete respiratory stop. The obstructive apnea (OSA) is a mechanical relocation of the respiratory tract. In case of a central apnea the central respiration reflex stops.

The hypopnea is a reduction of the air flow by more than 50 % (reduced oxygen saturation.)

Index, AHI (RDI) is the degree for the severity of the disease.

An apnea/hypopnea lasts at least 10 sec. The apnea per hour sleep are counted, 10 apnea per hour result in an index of 10.

An index of 0 to 5 is normal, when the index is 5 to 10 there is a median disease and at an index of 20 and more there is a severe disease. In other countries the graduation is slightly different.

An obstructive apnea is characterized by an interruption of the very noiseful rhonchopathy. A central apnea runs without external signs.



area of the obstruction

obstructive sleep apnea, obstructed pharynx

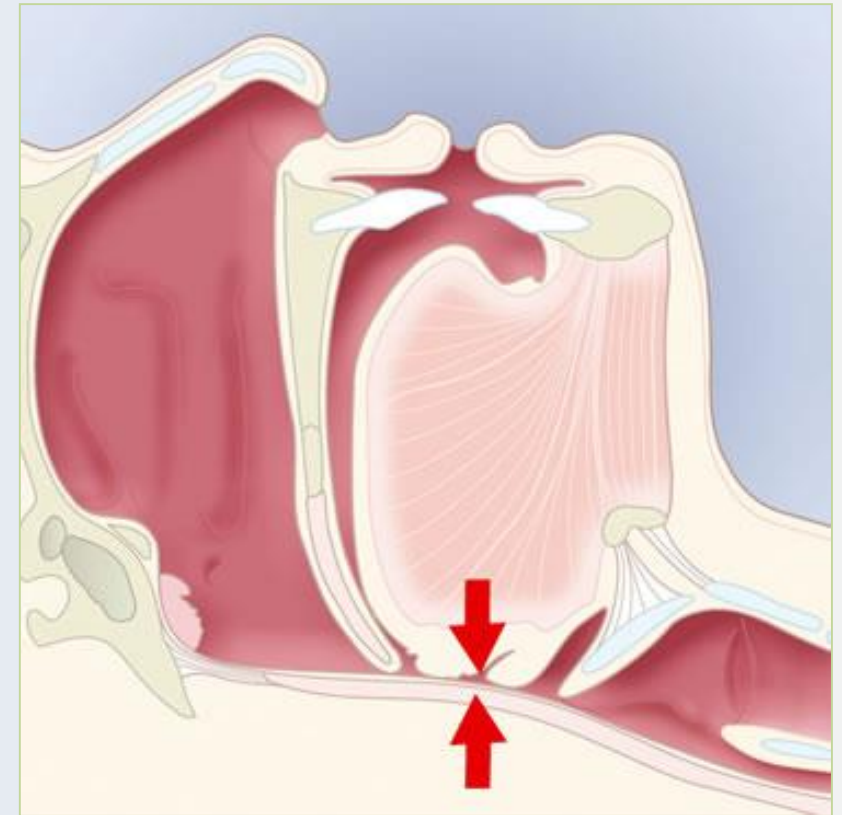

## Symptoms and consequences of the OSA

The main symptom of the obstructive sleep apnea is a loud, irregular snoring, the rhonchopathy.

Family members might also report of pauses in breathing that are ended by the „arousal“, a loud „implosive“ restart of the snoring.

A non-treated OSA leads to mostly chronic cardiovascular diseases.

### Further symptoms of the OSA:

- restless sleep with difficulties staying asleep
- tiredness during the day, microsleep, strong desire to sleep
- headache and vertigo after awakening and getting up
- dry mouth
- sweating during the night
- increased urge to urinate during the night (nycturia)
- lack of concentration
- depressive mood
- impotence (erectile dysfunction)

### Health consequences of the OSA:

- hypertension
- myocardial infarction
- apoplectic stroke
- sudden cardiac death with increased probability
- cardiac arrhythmia
- depressions
- stomach ulcer, hearing loss and other stress diseases
- diabetes mellitus

## Diagnostic investigation:

### Ambulatory snoring investigation:

Home screening, mostly an investigation for one night at home.



Diagnostic apparatus usable at home, in familiar surroundings, for collection of:

- air-flow and snoring
- heart rate
- oxygen saturation
- body position
- thoracic and abdominal movements



In-patient polysomnography:  
In a sleep laboratory, mostly for two nights in order to minimize influences of the unfamiliar surroundings.



Extensive investigation in a sleep laboratory for collection of:

- electro-encephalogram of the brain (EEG)
- rhythm of the heart (ECG)
- oxygen level of the blood (pulse oxymetry)
- body temperature
- air-flow (mouth and nose)
- respiratory movement
- muscle tension (EMG)
- leg movement
- eye movement (EOG)
- body position



## Therapy

(N) CPAP (Nasal) Continuous Positive Air Pressure.

Continuous (nasal) positive pressure of the respiratory air during the sleep.

The NCPAP respiratory mask is the therapeutical „gold standard“ in case of an obstructive sleep apnea.

The side effects like irritated nasal mucosa and pharynx by the desiccative air flow, irritated conjunctiva caused by leakages, pressure points and skin irritations, however, lead to a low acceptance (compliance), especially in case of a not severe disease.

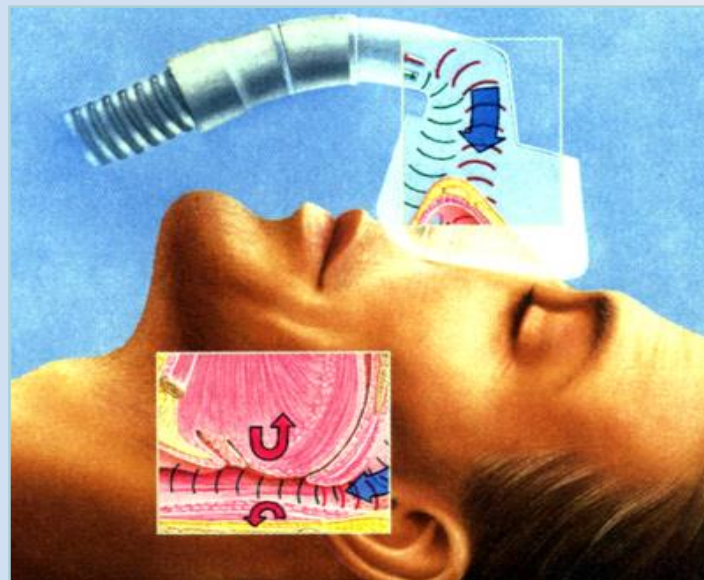

NCPAP function: Opening of the pharynx by continuous positive pressure of the respiratory air.

Modern units adapt the pressure to the respective airway resistance, also the Cheyne-Stokes-respiration is included.

The Cheyne-Stokes-respiration often occurs during the night at patients with advanced cardiac insufficiency (central sleep apnea syndrome). The result is a periodically recurring rise and fall of the respiration with changing respiratory frequency and respiratory pauses.



# Therapy

Surgery:  
surgical correction of a retrognathism.  
Complex, effective surgery.  
In very rare cases executed because of an OSA.

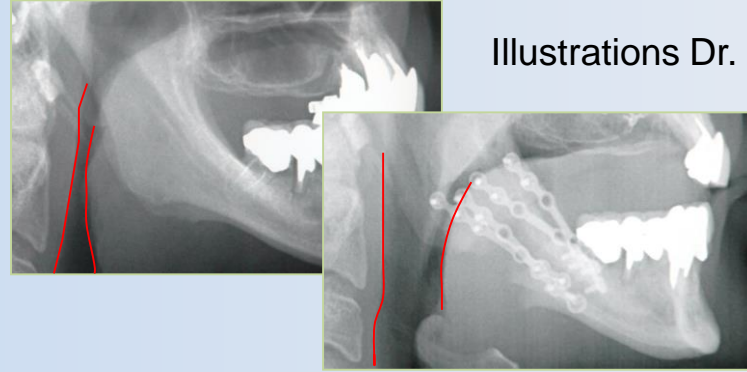

Illustrations Dr. Pelosi, Parma

The correction of the uvula and the ending soft palate is acceptable.  
The effectiveness, however, is evaluated very differently.



UPPP  
(Uvula-Palato-Pharyngo-Plastic)

Laser- and radio frequency ablation:  
Cicatrization to tighten the soft palate and correction of the uvula and the ending soft palate.

(for radio frequency ablation please see <http://www.dr.aschmann.de/de/behandlung.htm>)

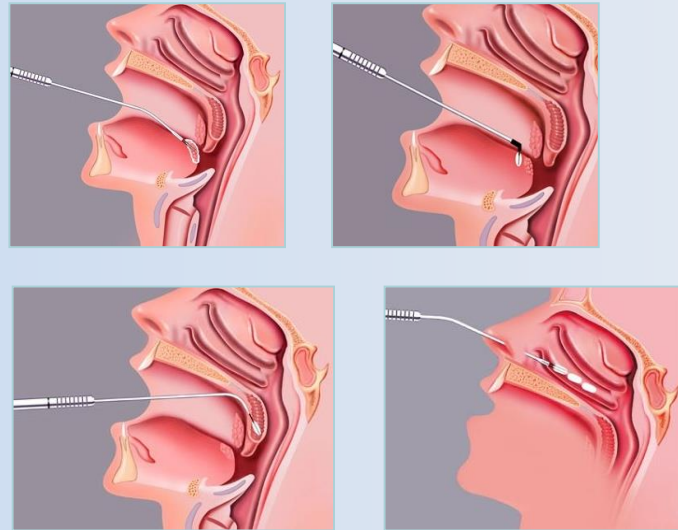

The total removal of the uvula has to be seen very critically because of the very inconvenient side-effects.



Implantive surgery, plastic rods are implanted to stiffen the structures.



# Oral appliances

tongue retainer keep the tongue in an advanced position

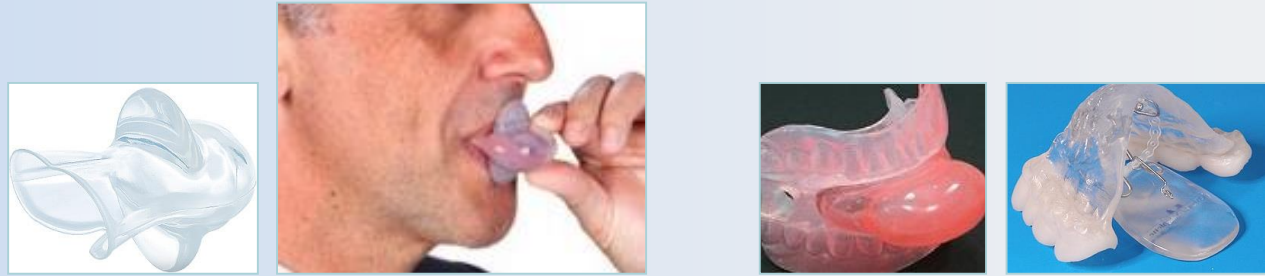

Aveo TSD, also suitable for edentulous persons

protrusion splints resp. MAS (mandibular advancement splints) keep the lower jaw in a defined advancement

Lower jaw and tongue are connected to each other in the area of the frontal pharynx by ligaments and muscles. An advancement of these structures increases the passage of the pharynx and thus reduces the obstruction.

MAS can function by pulling:



Silensor-sl



TAP-T



Narval

or by pushing:



IST, modified Herbst device



Sommodent

IST, modified Herbst device: Attention, If the mouth falls open, the respiratory tract is additionally narrowed. The device is thereby counter-productive, that means the mouth opening has to be limited (arrow)!

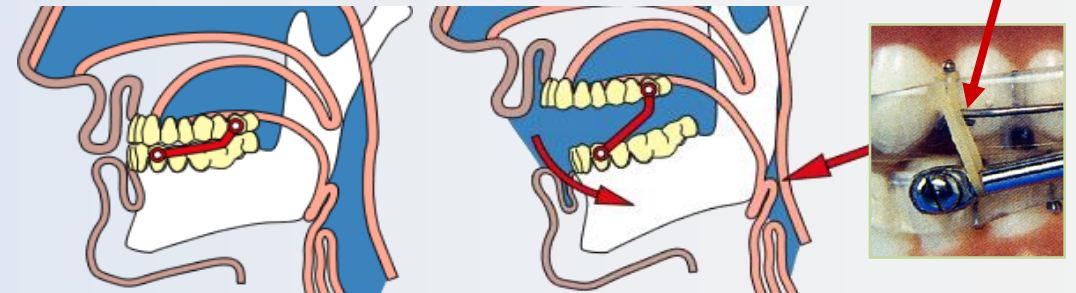

Protrusion splints that are realized as monobloc allow no or only little movement of the lower jaw. Studies have found that for this reason, there are slightly more TMJ (temporo mandibular joint) disorders to expect.

Therefore monobloc constructions should be rejected.





## Protrusion splints

The effectiveness of protrusion splints or MAS (mandibular advancement splints) is based on the fixation or defined advancement of the lower jaw.

Protrusion splints have a higher acceptance than tongue retainers, provided that they are not very voluminous and allow jaw movements.

If the lower jaw is advanced by 4 mm the front wall of the pharynx moves by about half to the front.

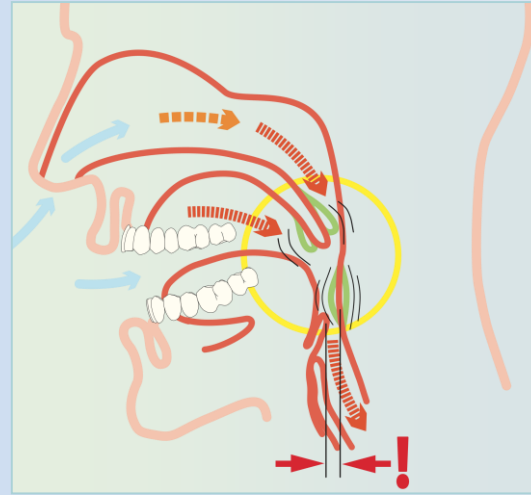

Snoring, narrowed pharynx

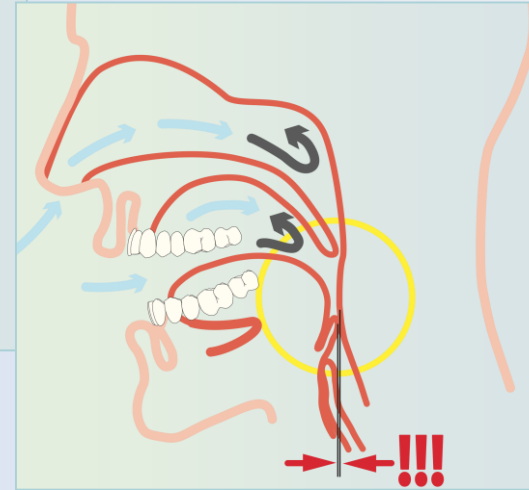

obstructive sleep apnea, closed pharynx

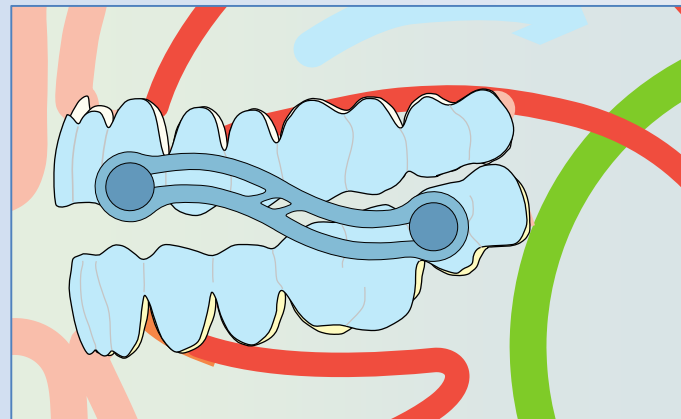

By advancement of the lower jaw and the root of the tongue the protrusion splint opens the respiratory tract in the pharyngeal area.

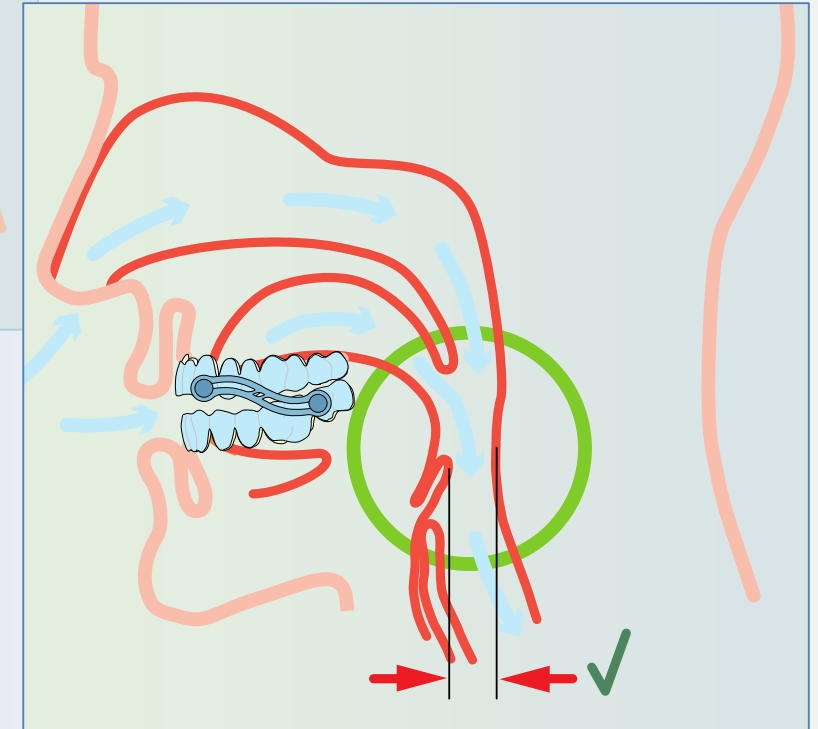

## Protrusion splints

Constructions based on pulling:

### Silensor-sl

Specially shaped connectors keep the lower jaw in a certain advancement.

The connectors are easily replaceable. The Silensor-sl is adjustable in graduations of 1 mm.

The Silensor-sl allows relatively large jaw movements.

The construction is metal-free to avoid galvanic currents.

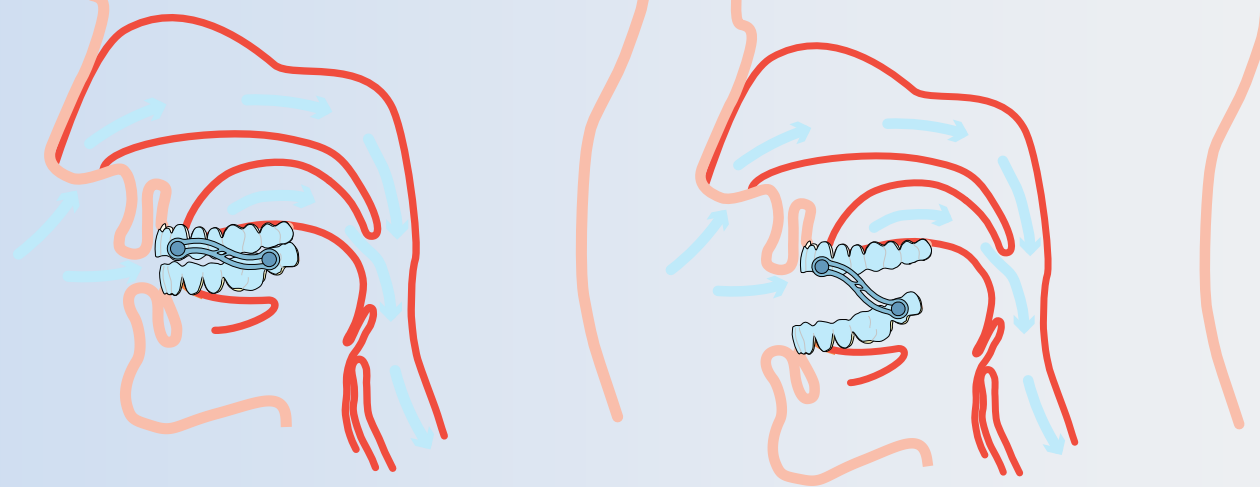

The versions that are based on pulling allow a large mouth opening and thereby additionally enlarge the respiratory tract.

### Silensor-sl:

In case of sudden propulsion movements the anchors may glide in the connectors.

The S-shape avoids a hard stop of the connectors.

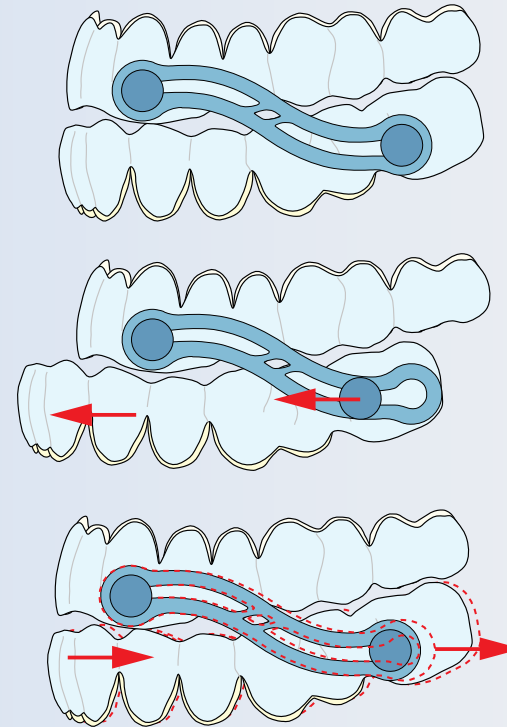

# Protrusion splints

Silensor-sl:

Therapeutical efficiency

X-ray examination of the University in Parma.

Advancement Silensor-sl:  
4 mm

without Silensor-sl

with Silensor-sl

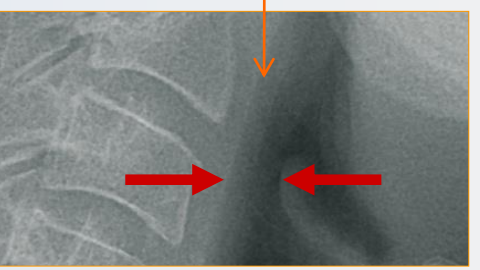
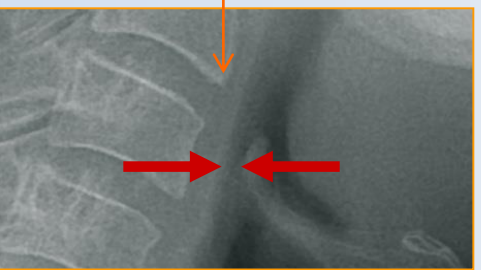
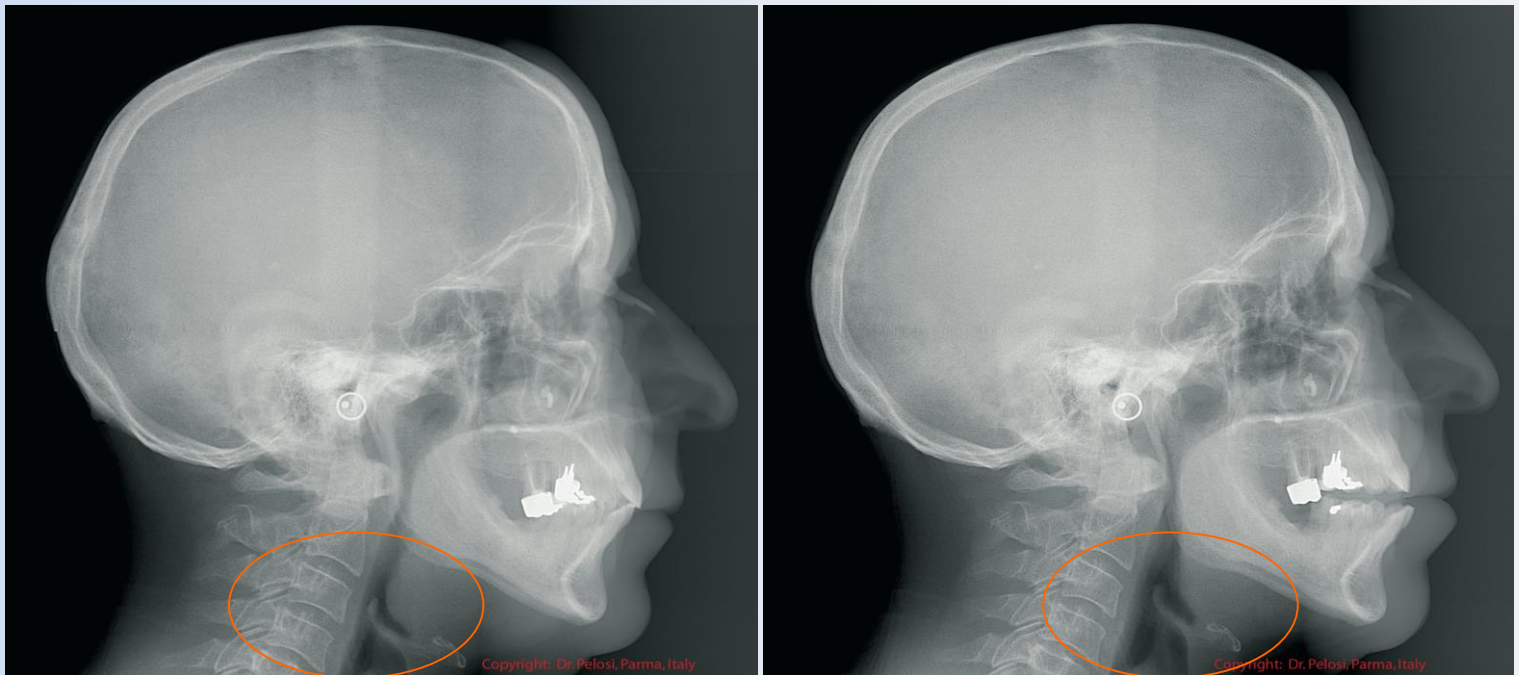

## Protrusion splints

Therapy with protrusion splints:

To avoid failures and to minimize undesired side effects there are some conditions and requirements to be observed.

The dentist should have experience in the splint therapy, evaluate the oral situation and know possible side effects.

On suspicion of an apnea disease the patient should be transferred to specialists.

### The patient:

Contraindications for the therapy with the Silensor-sl:

Apnea-index higher than 20 (more than 20 pauses in respiration per hour during sleep).

Inflammatory, painful temporomandibular jaw problems.

Loose tooth anchorage.

Less than 8 teeth per jaw.

Prognathic bite, protruding lower jaw, an advancement of the lower jaw is mostly not possible.

BMI (Body-Mass-Index) higher than 30. If the BMI is higher, the effect decreases continuously.

(BMI= body weight (kg) divided by body size<sup>2</sup> (m))

The same applies if the neck size exceeds 44 cm.

### The splint

should fulfill the following requirements:

All teeth are included.

No stiff connection of the jaws.

Individual adaptation with firm fit.

The advancement is adjustable.

Because of the needed acceptance the appliance is as comfortable as possible.

Metal free constructions are to be preferred.

## Protrusion splints

Therapy with protrusion splints,

the side effects:



The most important side effect are tooth movements, the splint should therefore compass all teeth, a firm attachment apparatus is required. Self control and control by the dentist is necessary.

Unpleasant, dragging sensation in the joint area that, however, decreases with the time.

Morning malocclusion, after removal of the splint the patient feels a more or less considerably changed bite situation until the reorientation of the masticatory musculature. It is very individual how long this lasts. However, this does not have any consequences according to several studies.

Periodontic pain, pain in the periodontium, the splint is too tight.

Excessive salivation, the more voluminous the construction is the stronger the salivation is. After a certain time of wearing, however, a reduction of the salivation can be assumed.

# Findings

The questionnaire of the Silensor-sl flyer shall help to clarify the intensity of snoring and if there might be a sleep apnea.

The result gives recommendations for a further clarification and treatment.

### Questionnaire:

This questionnaire has been designed to determine the potential suitability of a Silensor-sl to reduce snoring and obstructive sleep apnea.

It may be useful to have the patient discuss the questions with his or her partner.

The questionnaire does not claim to be complete. Mostly the results shown can only be considered as tendency. Further steps for finding results are perhaps necessary.

Do you feel stiffness in the area of the temporomandibular (jaw) joints?

Do your facial muscles feel strained or tense in the morning?

Do you grind or clench your teeth?



Do you also snore on the side?

Do you snore every night?

Do you snore noisily?

Do you feel tired on waking up?

Do you sleep fitfully, is your bed crumpled in the morning?

Do you wake up with headache?

Do you have problems concentrating for long periods?

Does sleep suddenly overcome you during the day?

Do you snore noisily with irregular interruptions?

Does your breathing stop (apneas) at any time during sleep?

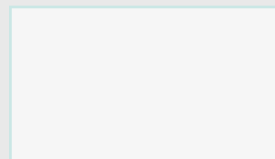

Your name:

Your address:

Your phone no.:

Your weight:

Your size:

BMI\*:

\*body-mass-index: body weight divided by the square of the body size:  

$$\frac{\text{body weight (kg)}}{\text{body size} \times \text{body size (m)}}$$

	no	sometimes	often	yes
Do you feel stiffness in the area of the temporomandibular (jaw) joints?	<input type="checkbox"/>	<input type="checkbox"/>	<input type="checkbox"/>	<input type="checkbox"/>
Do your facial muscles feel strained or tense in the morning?	<input type="checkbox"/>	<input type="checkbox"/>	<input type="checkbox"/>	<input type="checkbox"/>
Do you grind or clench your teeth?	<input type="checkbox"/>	<input type="checkbox"/>	<input type="checkbox"/>	<input type="checkbox"/>
<b>If your dentist confirms these findings a Silensor-sl can be used.</b>			<b>A Silensor-sl can only be used after successful therapy .</b>	
Do you also snore on the side?	<input type="checkbox"/>	<input type="checkbox"/>	<input type="checkbox"/>	<input type="checkbox"/>
Do you snore every night?	<input type="checkbox"/>	<input type="checkbox"/>	<input type="checkbox"/>	<input type="checkbox"/>
Do you snore noisily?	<input type="checkbox"/>	<input type="checkbox"/>	<input type="checkbox"/>	<input type="checkbox"/>
Do you feel tired on waking up?	<input type="checkbox"/>	<input type="checkbox"/>	<input type="checkbox"/>	<input type="checkbox"/>
Do you sleep fitfully, is your bed crumpled in the morning?	<input type="checkbox"/>	<input type="checkbox"/>	<input type="checkbox"/>	<input type="checkbox"/>
Do you wake up with headache?	<input type="checkbox"/>	<input type="checkbox"/>	<input type="checkbox"/>	<input type="checkbox"/>
Do you have problems concentrating for long periods?	<input type="checkbox"/>	<input type="checkbox"/>	<input type="checkbox"/>	<input type="checkbox"/>
Does sleep suddenly overcome you during the day?	<input type="checkbox"/>	<input type="checkbox"/>	<input type="checkbox"/>	<input type="checkbox"/>
Do you snore noisily with irregular interruptions?	<input type="checkbox"/>	<input type="checkbox"/>	<input type="checkbox"/>	<input type="checkbox"/>
Does your breathing stop (apneas) at any time during sleep?	<input type="checkbox"/>	<input type="checkbox"/>	<input type="checkbox"/>	<input type="checkbox"/>
<b>Presumably you only suffer from primary snoring without impairment of your health. The Silensor-sl can be fabricated in the normal bite situation.</b>			<b>Presumably you suffer from a rhonchopathy or even of an obstructive sleep apnea. The Silensor-sl has to keep your lower jaw in an advanced position.</b>	

**Upon suspicion of a sleep apnea a specialist in sleep medicine has to be additionally consulted.**

P72-3106-2

# Do you snore ...?

# Silensor-sl



**ERKODENT**®

Erkodent Erich Kopp GmbH • Siemensstr.  
 72285 Pfalzgrafenweiler • Germany  
 Tel.: + 49 (0) 74 45/85 01-0 • Fax: + 49 (0)  
 info@erkodent.com • www.erkodent.c

# Fabrication

The questionnaire gives a trend information on the sleep patterns of the patients, the capability of treatment and the adjustment of the Silensor-sl.

	no	sometimes	often	yes
Do you feel stiffness in the area of the temporomandibular (jaw) joints?	<input checked="" type="checkbox"/>	<input type="checkbox"/>	<input type="checkbox"/>	<input type="checkbox"/>
Do your facial muscles feel strained or tense in the morning?	<input type="checkbox"/>	<input checked="" type="checkbox"/>	<input type="checkbox"/>	<input type="checkbox"/>
Do you grind or clench your teeth?	<input checked="" type="checkbox"/>	<input type="checkbox"/>	<input type="checkbox"/>	<input type="checkbox"/>
If your dentist confirms these findings a Silensor-sl can be used.			A Silensor-sl can only be used after successful therapy.	

	no	sometimes	often	yes
Do you feel stiffness in the area of the temporomandibular (jaw) joints?	<input checked="" type="checkbox"/>	<input type="checkbox"/>	<input type="checkbox"/>	<input type="checkbox"/>
Do your facial muscles feel strained or tense in the morning?	<input checked="" type="checkbox"/>	<input type="checkbox"/>	<input type="checkbox"/>	<input type="checkbox"/>
Do you grind or clench your teeth?	<input type="checkbox"/>	<input checked="" type="checkbox"/>	<input type="checkbox"/>	<input type="checkbox"/>
If your dentist confirms these findings a Silensor-sl can be used.			A Silensor-sl can only be used after successful therapy.	

	no	sometimes	often	yes
Do you feel stiffness in the area of the temporomandibular (jaw) joints?	<input checked="" type="checkbox"/>	<input type="checkbox"/>	<input type="checkbox"/>	<input type="checkbox"/>
Do your facial muscles feel strained or tense in the morning?	<input type="checkbox"/>	<input type="checkbox"/>	<input checked="" type="checkbox"/>	<input type="checkbox"/>
Do you grind or clench your teeth?	<input checked="" type="checkbox"/>	<input type="checkbox"/>	<input type="checkbox"/>	<input type="checkbox"/>
If your dentist confirms these findings a Silensor-sl can be used.			A Silensor-sl can only be used after successful therapy.	

Do you also snore on the side?	<input type="checkbox"/>	<input checked="" type="checkbox"/>	<input type="checkbox"/>	<input type="checkbox"/>
Do you snore every night?	<input type="checkbox"/>	<input type="checkbox"/>	<input checked="" type="checkbox"/>	<input type="checkbox"/>
Do you snore noisily?	<input type="checkbox"/>	<input checked="" type="checkbox"/>	<input type="checkbox"/>	<input type="checkbox"/>
Do you feel tired on waking up?	<input type="checkbox"/>	<input checked="" type="checkbox"/>	<input type="checkbox"/>	<input type="checkbox"/>
Do you sleep fitfully, is your bed crumpled in the morning?	<input checked="" type="checkbox"/>	<input type="checkbox"/>	<input type="checkbox"/>	<input type="checkbox"/>
Do you wake up with headache?	<input type="checkbox"/>	<input checked="" type="checkbox"/>	<input type="checkbox"/>	<input type="checkbox"/>
Do you have problems concentrating for long periods?	<input checked="" type="checkbox"/>	<input type="checkbox"/>	<input type="checkbox"/>	<input type="checkbox"/>
Does sleep suddenly overcome you during the day?	<input checked="" type="checkbox"/>	<input type="checkbox"/>	<input type="checkbox"/>	<input type="checkbox"/>
Do you snore noisily with irregular interruptions?	<input checked="" type="checkbox"/>	<input type="checkbox"/>	<input type="checkbox"/>	<input type="checkbox"/>
Does your breathing stop (apneas) at any time during sleep?	<input checked="" type="checkbox"/>	<input type="checkbox"/>	<input type="checkbox"/>	<input type="checkbox"/>

Do you also snore on the side?	<input type="checkbox"/>	<input type="checkbox"/>	<input checked="" type="checkbox"/>	<input type="checkbox"/>
Do you snore every night?	<input type="checkbox"/>	<input type="checkbox"/>	<input checked="" type="checkbox"/>	<input type="checkbox"/>
Do you snore noisily?	<input type="checkbox"/>	<input type="checkbox"/>	<input checked="" type="checkbox"/>	<input type="checkbox"/>
Do you feel tired on waking up?	<input type="checkbox"/>	<input checked="" type="checkbox"/>	<input type="checkbox"/>	<input type="checkbox"/>
Do you sleep fitfully, is your bed crumpled in the morning?	<input type="checkbox"/>	<input type="checkbox"/>	<input checked="" type="checkbox"/>	<input type="checkbox"/>
Do you wake up with headache?	<input type="checkbox"/>	<input type="checkbox"/>	<input checked="" type="checkbox"/>	<input type="checkbox"/>
Do you have problems concentrating for long periods?	<input type="checkbox"/>	<input checked="" type="checkbox"/>	<input type="checkbox"/>	<input type="checkbox"/>
Does sleep suddenly overcome you during the day?	<input type="checkbox"/>	<input checked="" type="checkbox"/>	<input type="checkbox"/>	<input type="checkbox"/>
Do you snore noisily with irregular interruptions?	<input type="checkbox"/>	<input type="checkbox"/>	<input type="checkbox"/>	<input type="checkbox"/>
Does your breathing stop (apneas) at any time during sleep?	<input type="checkbox"/>	<input checked="" type="checkbox"/>	<input type="checkbox"/>	<input type="checkbox"/>

Do you also snore on the side?	<input type="checkbox"/>	<input type="checkbox"/>	<input type="checkbox"/>	<input checked="" type="checkbox"/>
Do you snore every night?	<input type="checkbox"/>	<input type="checkbox"/>	<input type="checkbox"/>	<input checked="" type="checkbox"/>
Do you snore noisily?	<input type="checkbox"/>	<input type="checkbox"/>	<input type="checkbox"/>	<input checked="" type="checkbox"/>
Do you feel tired on waking up?	<input type="checkbox"/>	<input type="checkbox"/>	<input checked="" type="checkbox"/>	<input type="checkbox"/>
Do you sleep fitfully, is your bed crumpled in the morning?	<input type="checkbox"/>	<input type="checkbox"/>	<input checked="" type="checkbox"/>	<input type="checkbox"/>
Do you wake up with headache?	<input type="checkbox"/>	<input type="checkbox"/>	<input checked="" type="checkbox"/>	<input type="checkbox"/>
Do you have problems concentrating for long periods?	<input type="checkbox"/>	<input type="checkbox"/>	<input checked="" type="checkbox"/>	<input type="checkbox"/>
Does sleep suddenly overcome you during the day?	<input type="checkbox"/>	<input type="checkbox"/>	<input type="checkbox"/>	<input checked="" type="checkbox"/>
Do you snore noisily with irregular interruptions?	<input type="checkbox"/>	<input type="checkbox"/>	<input checked="" type="checkbox"/>	<input type="checkbox"/>
Does your breathing stop (apneas) at any time during sleep?	<input type="checkbox"/>	<input type="checkbox"/>	<input type="checkbox"/>	<input checked="" type="checkbox"/>

Presumably you only suffer from primary snoring without impairment of your health. The Silensor-sl can be fabricated in the normal bite situation.

The Silensor-sl has to keep your lower jaw in an advanced position.

The Silensor-sl has to keep your lower jaw in an advanced position.

Upon suspicion of a sleep apnea a specialist in sleep medicine has to be additionally consulted.

# Case example

Patient with an AHI of 76!

Almost complete reduction of the rhonchopathy with the Silensor-sl but insufficient reduction of the apneas!

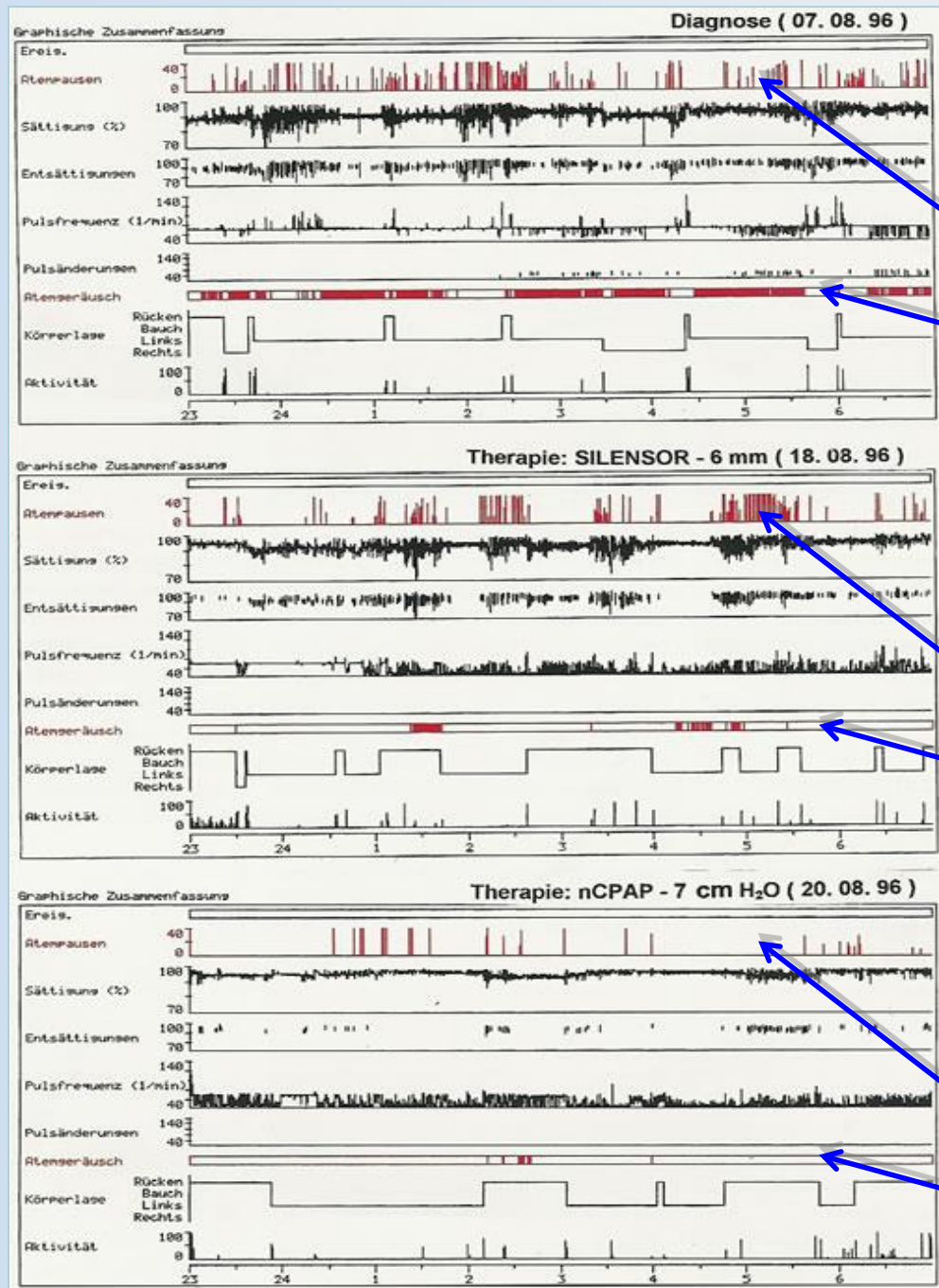

Initial situation:  
 pauses in respiration (apnea)  
 respiratory sounds (snoring)

Silensor-sl:  
 pauses in respiration (apnea)  
 respiratory sounds (snoring)

NCPAP:  
 pauses in respiration (apnea)  
 respiratory sounds (snoring)



# Literature/studies

Many studies with protrusion splints inclusive the Silensor-sl are available.

Statistical, many studies summarizing theses show an effectiveness against snoring of 82 % and an average reduction of the obstructive sleep apnea index of 54 %.

Treatment of snoring and obstructive sleep apnea with a mandibular protruding device: an open – label study Anette M.C. Fransson et al., sleep and breathing, vol. 5/1 2001

Oral appliances for snoring and obstructive sleep apnea: a review Kathleen A. Ferguson et al., sleep, Vol. 29/2, 2006



## Mandibular advancement splints and continuous positive airway pressure in patients with obstructive sleep apnoea: a randomized cross-over trial

Y. K. Tan\*, P. R. L'Estrange\*, Y.-M. Luo\*, C. Smith\*, H. R. Grant\*, A. K. Simonds\*\*, S. G. Spiro\* and J. M. Battagel\*\*\*

\*Department of Respiratory Medicine, University College London Hospitals, \*\*Royal Brompton and Harefield NHS Trust and \*\*\*Department of Orthodontics, St Bartholomew's and the Royal London School of Medicine and Dentistry, UK

**SUMMARY** This prospective, randomized, cross-over trial was designed to compare the efficacy of a mandibular advancement splint (MAS) with that of nasal continuous positive airway pressure (nCPAP) in patients with obstructive sleep apnoea (OSA). Twenty-four patients (20 males and four females) with mild to moderate OSA (AHI between 10 and 49 events per hour) were enrolled in the study. Each patient used both MAS and nCPAP, with the initial therapy being allocated at random. Treatment periods lasted for two months with a two-week wash-out interval between. Polysomnography was performed prior to the study and after each clinical intervention. Patient and partner questionnaires were used to assess changes in general health and daytime somnolence.

### Efficacy of Mandibular Advancement Splint for Treatment of OSA: Report at Three Months of a One-Year Follow-Up Study

Tea Galić, N. Talija I ković, Renata Pecotić, Joško Bžić, Tina Tičinović Kurir, Gušo Gnjača, Maja Valić, Goran Rudić, Zoran Bogas  
University of Split, School of Medicine, Split, Croatia

#### INTRODUCTION

Mandibular advancement splint *Silensor-sl* (MAS) can effectively treat mild to moderate obstructive sleep apnea (OSA). It is worn during sleep to maintain the patency of the upper airway by increasing its dimensions and reducing its collapsibility. Although less efficacious than continuous positive airway pressure (CPAP) for improving the polysomnographic indexes of OSA, MAS is generally preferred by patients which ensures better compliance and may provide an equivalent health outcome. MAS have been shown to have a beneficial impact on numerous clinical outcomes, including the polysomnographic indexes of OSA, subjective and objective measures of sleepiness, blood pressure, aspects of neurophysiological functioning, and quality of life. In this study we sought to evidence the efficacy of specific mandibular advancement splint *Silensor-sl* and the long-term impact on numerous clinical outcomes.

#### METHODS

- 7 patients with mild to moderate OSA
- patients were initially screened for dental status; inclusion criteria was at least 6 healthy teeth in each dental arch
- dental impressions and lateral cephalometric radiographs were obtained prior to the initiation of the treatment
- arterial stiffness, blood pressure and metabolic blood parameters were measured at baseline and after 3 months of MAS treatment
- treatment outcome was determined by polysomnography



#### RESULTS

Variable	Total	Male	Female
Patients N	7 (100)	5 (71)	2 (29)
Age, yr	54.67±5.16	53.64±7.30	52.5±5.54
Height, (cm)	180.3±7.74	184.0±5.3	171.0±0
Weight, (kg)	89.43±7.74	89.6±7.02	89.0±12.73
BMI(kg /m <sup>2</sup> )	27.7±3.61	26.6±3.06	30.4±4.35
ESS score	6.29±3.40	6.6±4.1	5.5±0.71
Neck circumference, (cm)	41.79±2.94	43.3±1.57	38±1.411
STOP questionnaire N (%)			
High risk (>2)	7(100)	5(100)	2(100)
Low risk (<2)	0(0)	0(0)	0(0)

TABLE 1 DEMOGRAPHIC CHARACTERISTICS OF PATIENTS  
Values are given as No. (%), unless otherwise indicated. NS-not significant; ESS-Epworth Sleepiness Score; STOP-snoring, tiredness, observed apnea, and high risk; ESS-Epworth Sleepiness Score; STOP-snoring, tiredness, observed apnea, and high risk

Variables	Baseline before MAS treatment	At 3 months on MAS treatment	P value
ESS score	6.29±3.40	6.0±4.30	NS
AHI (events/hr)	21.79±5.78	10.76±3.98	0.0156
Minimum SpO <sub>2</sub>	84.0±5.35	86.57±2.64	NS
Mean SO <sub>2</sub>	94.29±1.98	95.14±1.21	NS
Snoring time (min)	264.3±199.48	165.29±182.79	NS
Fibrinogen (g/L)	3.13±0.73	3.46±0.89	NS
Total cholesterol (mmol/L)	5.74±1.08	5.94±1.33	NS
Cortisol (nmol/L)	372.57±83.98	353.37±107.71	NS
FPG (mmol/L)	5.0±0.33	4.86±0.4	NS
FPI (pmol/L)	75.46±80.53	72.27±74.65	NS
HR (beats/min)	68.67±19.82	64.43±12.35	NS
Systolic BP (mmHg)	129.57±20.53	126.43±12.08	NS
Diastolic BP (mmHg)	76.0±11.58	77.14±5.37	NS

TABLE 2 EFFECTS OF MANDIBULAR ADVANCEMENT SPLINT ON EPWORTH SLEEPINESS AND METABOLISM  
Values are given as means±SD or No. (%), unless otherwise indicated. NS-not significant; MAS-mandibular advancement splint; ESS-Epworth Sleepiness Score; AHI-apnoea-hypopnoea index; SpO<sub>2</sub>-pulse oximeter oxygen saturation; FPG-fasting plasma glucose; FPI-fasting plasma insulin; HR-heart rate; BP-blood pressure. P value<0.05 was considered to be statistically significant.

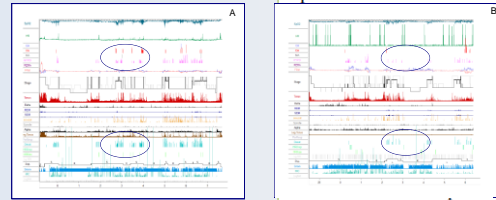

FIGURE 1 Whole night polysomnography data for two patients. A - Prior to MAS treatment; B - At 3 months on MAS treatment

Mandibular advancement splint *Silensor-sl* may be effective in the treatment of moderate to severe obstructive sleep apnoea. The significant changes in arterial stiffness, blood pressure and metabolic blood parameters, did not occur in 3 months of treatment, but our study will be continued to 1-year treatment period.

#### REFERENCES

- Chan ASL, Lee RWW, Cistulli PA. Dental appliance for obstructive sleep apnoea. *Chest*. 2007;132:693-699.
- Itzaki S, Dorchin H, Clark G, Lavie L, Lavie G. The effects of 1-year treatment with a Herbst mandibular advancement splint on obstructive sleep apnoea, oxidative stress, and endothelial function. *Chest*. 2007;131:740-749.
- Phillips CL, Yee B, Yang Q, Villaneuva AT, Hedner J, Berend N, Grunstein R. Effects of continuous positive airway pressure treatment and withdrawal in patients with obstructive sleep apnea on arterial stiffness and central BP. *Chest*. 2008;134:94-100.

242

purpose of the study, but assessment was carried out in a random order and with all patient identification removed.

**The oral appliance.** A soft, one-piece MAS was selected initially, similar to that described by Stradling *et al.* (1998). This vacuum-formed appliance was simple and cheap to construct, and designed to hold the mandible forward at the maximum comfortable protrusion, with no lateral jaw opening. The initial protrusive position approximated 75 per cent of maximal possible protrusion. Four-millimetre thick ethyl vinyl acetate blanks were processed over the models and two laterally



Figure 2 Modified Silensor appliance.

adjusted buccally (Figure 1). The upper and lower dental arches were advanced by replacing the original connector by a shorter one. Since modification of the splint design could have had an effect on outcome, results for the two types of splint were compared both separately and for the group as a whole.

**Nasal continuous positive airway pressure (nCPAP).** nCPAP was provided using the REM Star Choice machine (Respironics Inc., Medic-Aid, West Sussex, UK) at UCLH and the Sullivan Elite machine (Resmed UK Ltd, Abingdon, UK) at RBH. A comfortable nasal mask was selected and nasal corticosteroid sprays were prescribed to relieve nasal congestion if necessary. This symptom did not require treatment during the MAS arm of the study in any individual. Correct nCPAP pressures were titrated individually.



Figure 3 The effects of 1-year treatment with a mandibular advancement splint on obstructive sleep apnoea, oxidative stress, and endothelial function. Chest. 2007;131:740-749.

adjustment. The buccal connectors are available in four lengths and the mandible may be readily advanced by replacing the original connector by a shorter one. Since modification of the splint design could have had an effect on outcome, results for the two types of splint were compared both separately and for the group as a whole.

**Nasal continuous positive airway pressure (nCPAP).** nCPAP was provided using the REM Star Choice machine (Respironics Inc., Medic-Aid, West Sussex, UK) at UCLH and the Sullivan Elite machine (Resmed UK Ltd, Abingdon, UK) at RBH. A comfortable nasal mask was selected and nasal corticosteroid sprays were prescribed to relieve nasal congestion if necessary. This symptom did not require treatment during the MAS arm of the study in any individual. Correct nCPAP pressures were titrated individually.

**Diagnostic polysomnography.** All patients had a diagnostic polysomnography before entry into the study. At UCLH, the equipment was a Compumedics system (Compumedics Ltd, Victoria, Australia), which recorded sleep and its stages by electroencephalographic (EEG), electro-oculographic, and electromyographic (EMG) criteria. EEG was recorded with electrodes placed at C3-A2 and C4-A1 (according to the international 10-20 system). EMG activity was recorded from the submental muscles. A single pair of electrocardiographic chest leads was used

# Fabrication

sl-parts card for the fabrication of a Silensor-sl.

The Silensor-sl can be fabricated with and without registration (constructive checkbite).

The sl-protrusion gauge allows the fabrication of a Silensor-sl that exactly corresponds to the measured proportions in the mouth.

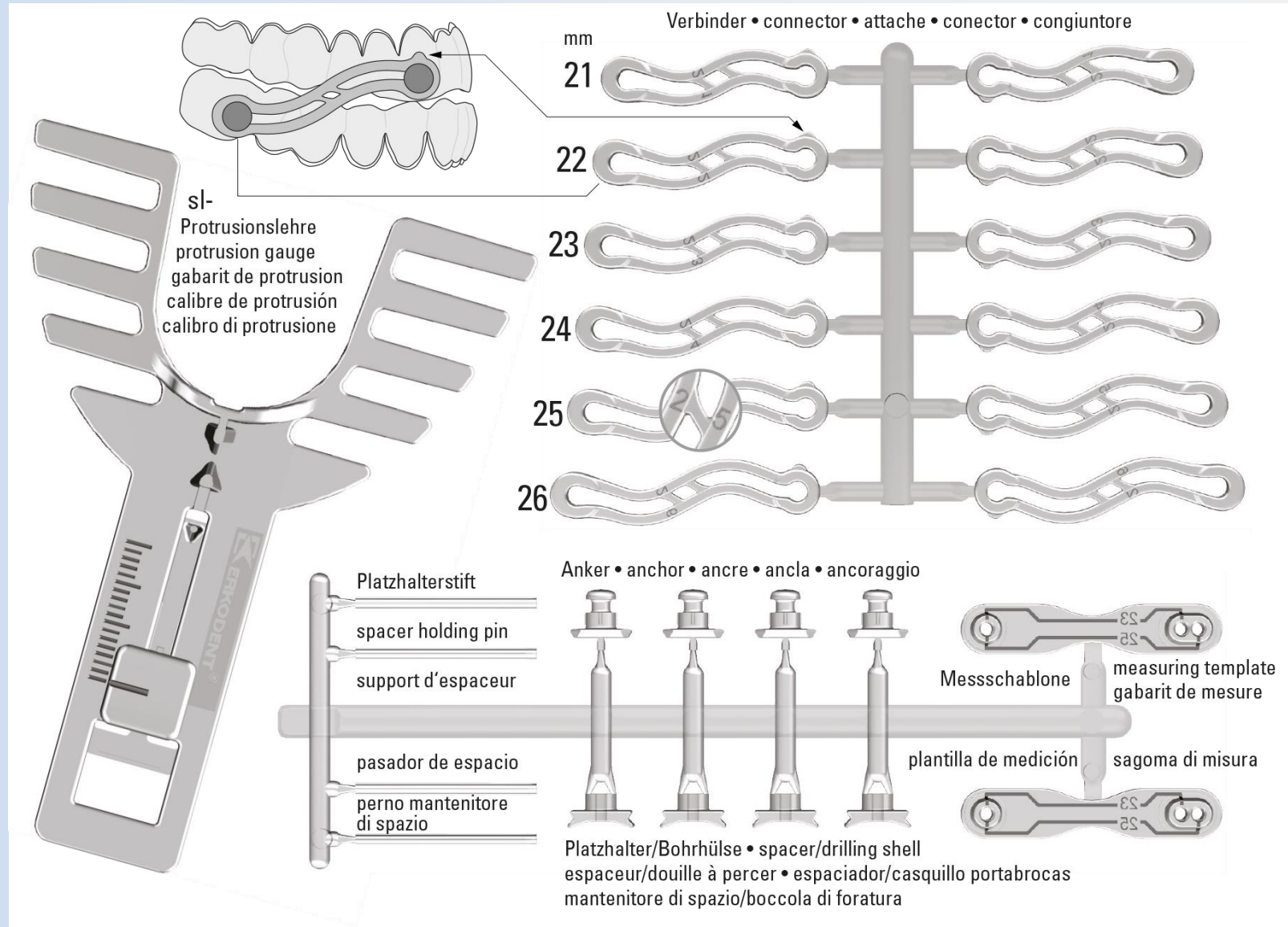

## The adjustment of the Silensor-sl

Select connector length: The connectors are easily exchangeable, for ex. if more protrusion is needed for a sufficient effect.

The shorter the connector is selected in relation to the measurement, the greater is the advancement of the lower jaw.

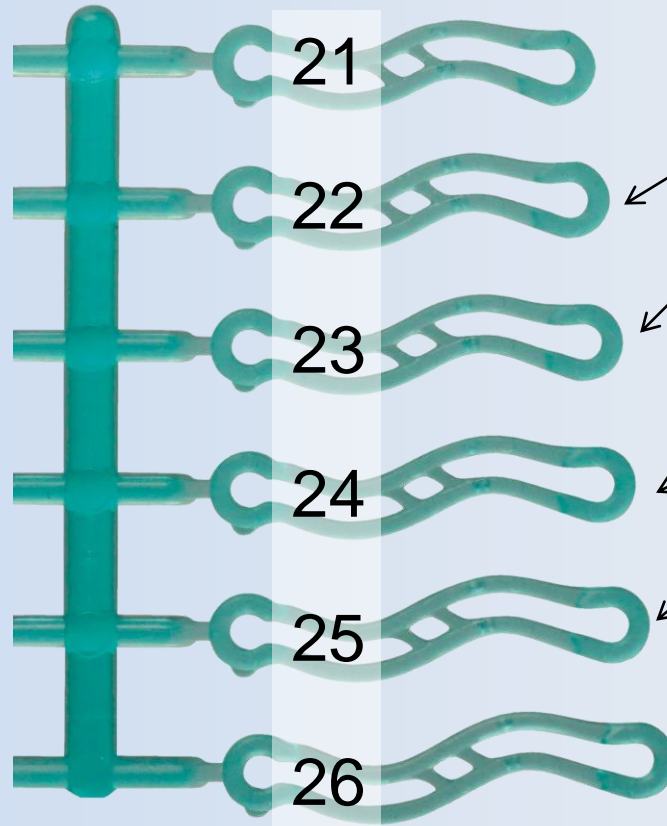

23 mm measured

without bite-taking select 22 mm connector

with bite-taking select 23 mm connector

25 mm measured

without bite-taking select 24 mm connector

with bite-taking select 25 mm connector

The 26 mm connector is used when the patient despite bite-taking does not accept the advancement.

## sl-protrusion gauge

The sl-protrusion gauge allows to register in a simple way the desired or recommended advancement for the Silensor-sl.

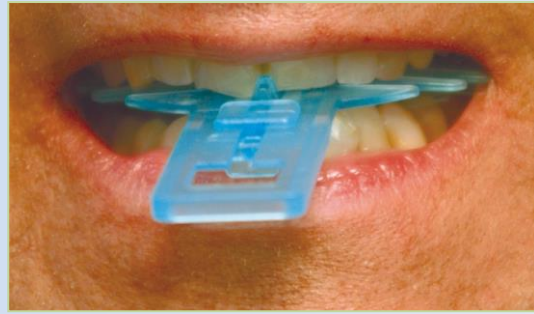

1. Marking of the normal bite situation with the sl-protrusion gauge.

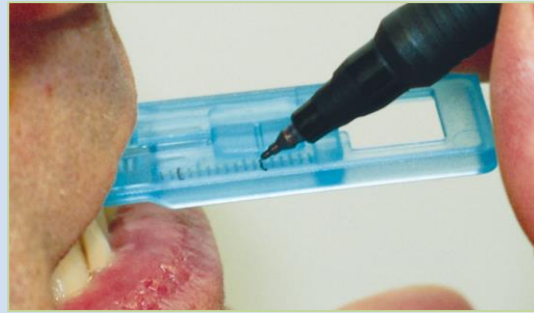
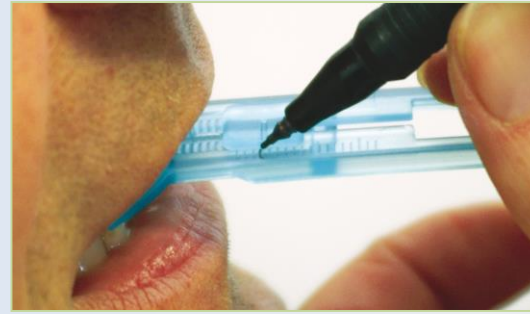

2. Marking of the maximum advancement.

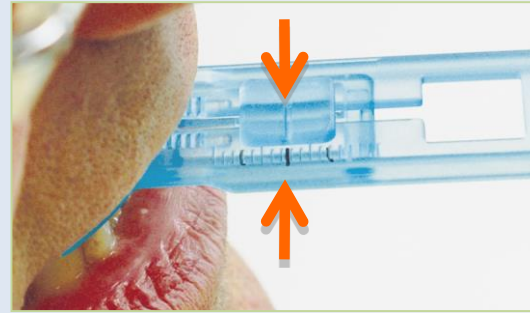

3. Marked desired protrusion.

Generally, half of the maximum protrusion is recommended as the advanced position of the lower jaw.

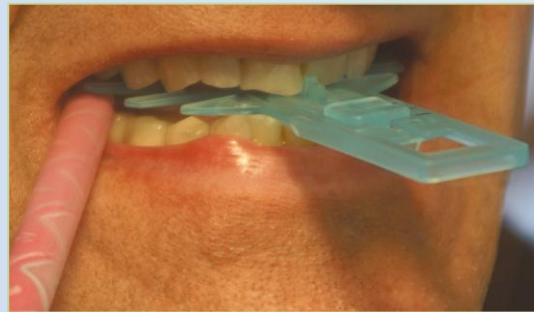

4. Registration.

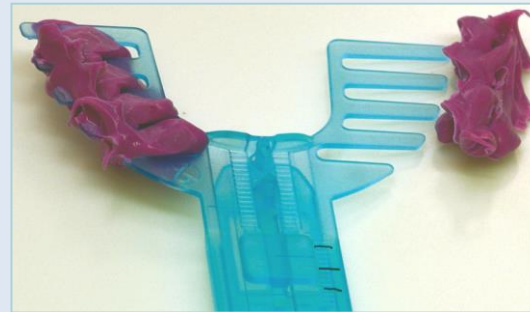

Sleep disorders and dentistry

Thank you very much  
for your attention

An overview of the manufacturing  
follows on the next pages.

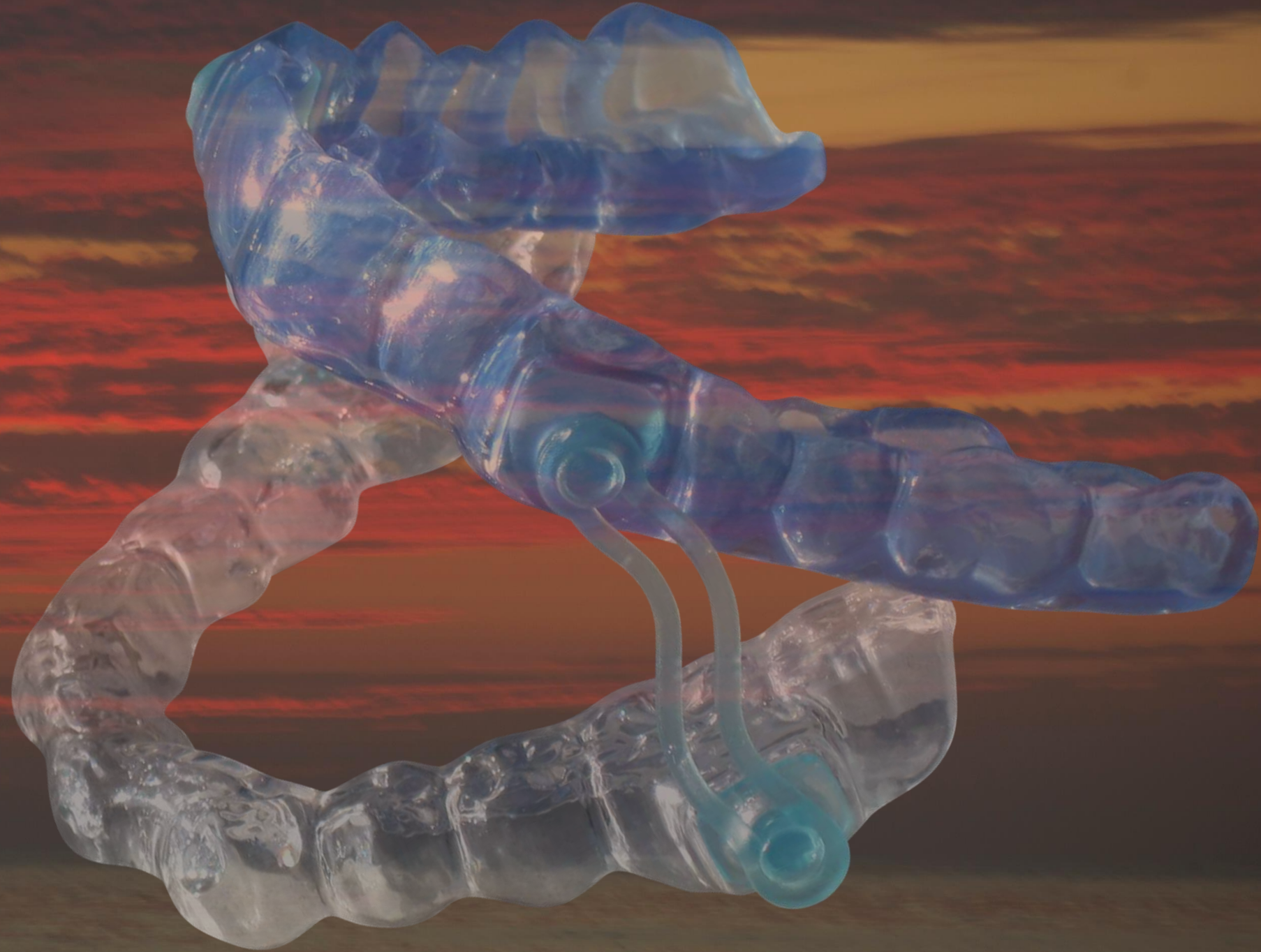

# Fabrication (Extract of the instructions)

## Model preparation

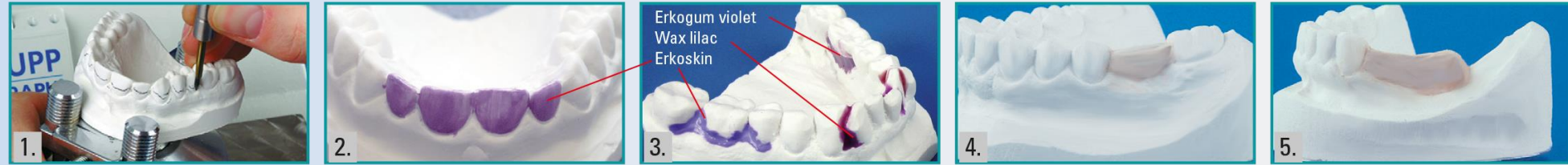

1. In case of a very retentive teeth situation, the marking of the prosthetic equator is recommended (1.).  
 With the exception of the fixation points, the splint ends in case of large undercuts at the equator, otherwise 1-2 mm below.  
 2. In case of using Erkodur (hard), relieve tension from the four upper front teeth by applying Erkoskin (2.).  
 3. Block out undercuts and spaces with Erkogum, block out bubbles in the plaster with high-fusing wax. Relieve tension from the gingival margin in the area where the splint possibly has contact (3.).  
 4. If the measuring point is located on an edentulous area, this must be filled with plaster (4.).  
 5. In case of a free-end situation, a plaster wall is put on the ridge (5.).

## Fabrication with construction bite



1. Separate the measuring templates.  
 25 mm or 23 mm ?, see hints, page 1, paragraph 4 + 5.

2. Articulate the models using a rubber band and the construction bite that has been taken off the sl-protrusion gauge and cut to shape.

3. Fix measuring template as near as possible to the occlusal plane with Erkogum. Initial point is the upper canine or canine area. The lower pivot point results from the measurement (see hints).  
 Fix the measuring template with the drilling shells that way that a parallel drilling is possible.

4. Cut the spacer holding pins.  
 Put the marked end in the drilled holes, see 7.

# Fabrication

## Fabrication with construction bite



**5.** Drill with the 1.4 mm drill (**10 000 rev./min.!**) through the drilling shell into the model, first in the canine area (3 mm depth of drilled hole or more).



**6.** Immediately insert a spacer holding pin through the drill guide. Only now drill the second hole. Drill the other side in the same way. Remove pins and templates ...

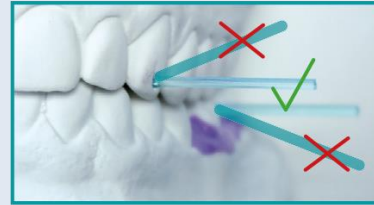

**7.** ... the models can now be separated. Now put all 4 spacer holding pins into the drilling holes. Strongly diverging spacer holding pins have to be adjusted.

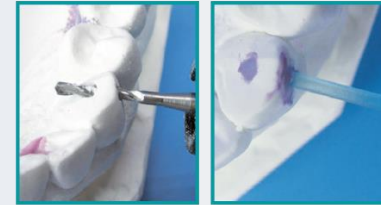

**Hint for drilling:** If the model has been drilled through, fix the spacer holding pin with Erkogum. Fix chipped plaster pieces and the pin with quick-acting glue.



**8.** Put a poor quantity of Erkogum violet onto the pins. Cut the spacers without overhang.

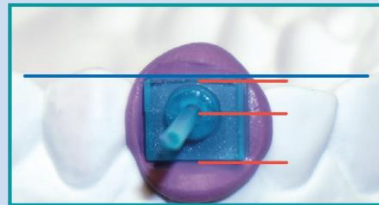

**9.** Push a spacer holder as illustrated onto the spacer holding pin and press it on as near as possible. The small side always points towards the **occlusal plane**.

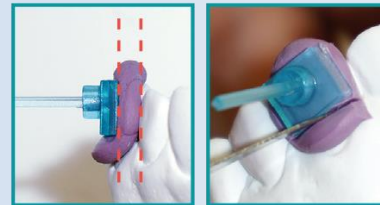

**10.** Pay attention to a parallelism of the modelling pads. Remove excessive Erkogum with a knife.

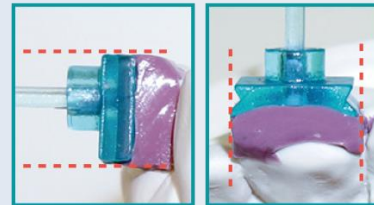

**11.** Undercuts between spacer holding pin and model have to be filled up.

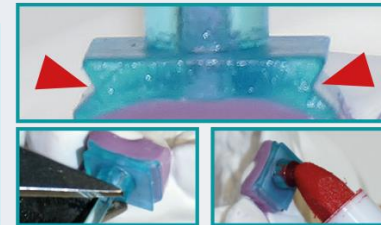

**12.** Marked areas have to be free of Erkogum. Cut all pins. Now mark the outermost surface of each spacer with an appropriate pen.

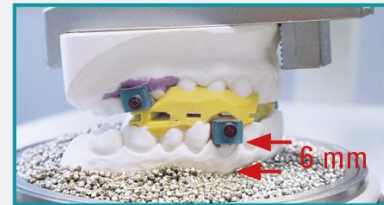

**13.** Articulate the models with the construction bite (Erkoform-3/3d/3d *motion* with Occluform-3). Leave the area below the spacer at least 6 mm free of granules.

# Fabrication

## Fabrication with construction bite



**14.** Keep the construction bite. Lower the bite at the supporting pin to a gap of app. 2 mm between the front teeth. Pull off the insulating foil of the Erkolen foil (1.0 mm) and keep it.

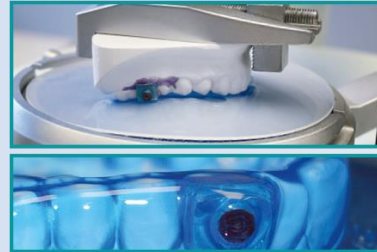

**15.** Now thermoform, immediately put the Erkolen foil (reusable) onto the model and close the Occluform. The result is a plane occlusal surface.



**16.** Now take a silicone key for the opposing bite (Aton-Lab 80). Put the modelling silicone in the unit onto the splint and imprint the opposing bite with the Occluform, if necessary, slightly adapt.



**17.** Take model with foil out of the Occluform model pot and roughly cut out (fissure bur > 20 000 rev./min.)



**18.** Lock the lower joint of the Occluform with the swivel screw. Fix lower jaw model in the Occluform model pot, fill up with granules and put the silicone key onto it. (Instructions Occluform)



**19.** Fix upper jaw model on the Occluform model plate. Articulate the models using the silicone key. Open the Occluform and remove the silicone key.



**20.** Press the cut insulating foil of the Erkolen foil with the adhesive side down on the occlusal surface of the splint.

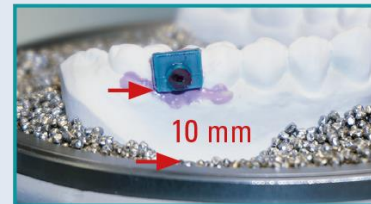

**21.** Pay attention that at least 10 mm around the spacers are free of granules.



**22.** Now execute the second thermoforming process. As soon as the foil is adapted, close the Occluform. Allow to cool completely. Uncover all spacers before taking the splints off the model. Thereto, **carefully** grind through the plate ...

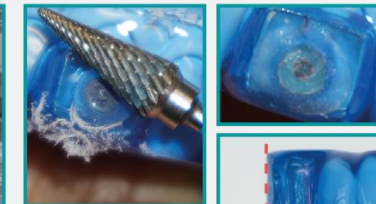

**23.** ... until the coloured marking on the spacers is just abraded, **not more and not less** (tungsten carbide bur > 20 000 rev./min.). **Ensure a plane surface.** Take the splints off the models.

continue at finishing



# Fabrication

## Fabrication without construction bite

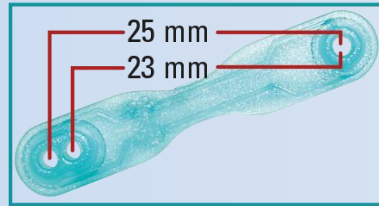

1. Separate the measuring templates.

25 mm or 23 mm ?, see hints, page 1, paragraph 4 + 5.



2. Articulate the models using a rubber band.

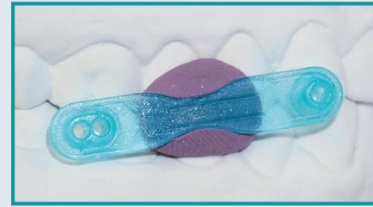

3. Fix measuring template as near as possible to the occlusal plane with Erkogum. Initial point is the upper canine or canine area. The lower pivot point results from the measurement (see hints).

Fix the measuring template with the drilling shells that way that a parallel drilling is possible.

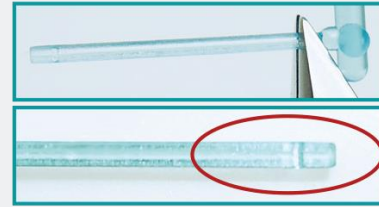
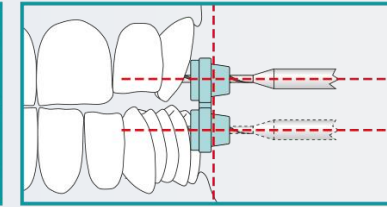

4. Cut off the spacer holding pins.

Put the marked end in the drilled holes, see 7.



5. Drill with the 1.4 mm drill (10 000 rev./min.!) through the drilling shell into the model, first in the canine area (3 mm depth of drilled hole or more).



6. Immediately insert a spacer holding pin through the drill guide. Only now drill the second hole. Drill the other side in the same way. Remove pins and templates ...



7. ... the models can now be separated. Now put all 4 spacer holding pins into the drilled holes. Strongly diverging spacer holding pins have to be adjusted.

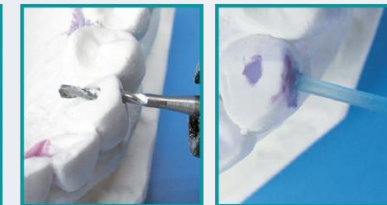

**Hint for drilling:** If the model has been drilled through, fix the spacer holding pin with Erkogum. Fix chipped plaster pieces and the pin with quick-acting glue.



8. Press a poor quantity of Erkogum violet onto the pins. Cut the spacers without overhang.

# Fabrication

## Fabrication **without** construction bite

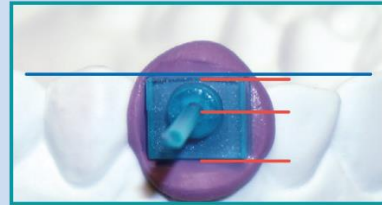

**9.** Push a spacer holder as illustrated onto the spacer holding pin and press it on as near as possible. The small side always points to the **occlusal plane**.

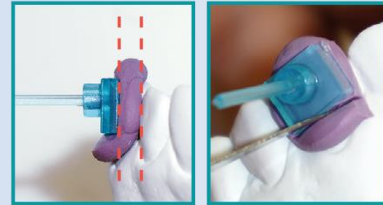

**10.** Pay attention to a parallelism of the modelling pads. Remove excessive Erkogum with a knife.

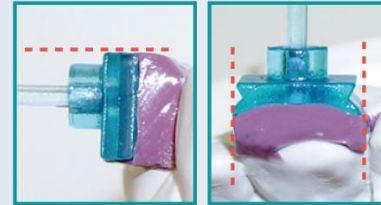

**11.** Undercuts between spacer holding pin and model have to be filled up.

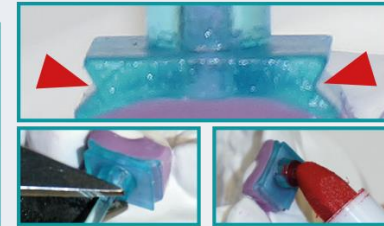

**12.** Marked areas have to be free of Erkogum. Now mark the outermost surface of each spacer with an appropriate pen.

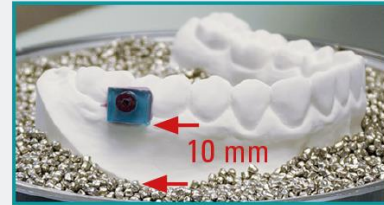

**13.** Embed the models into the granules, leave the area below the spacer at least 6 mm free of granules. Thermoform the models one after the other.



**14.** Immediately after the adaptation apply the Erkolen foil (1 mm) without insulating foil and press it on along the teeth row especially in the area of the front teeth, in doing so run with the ...

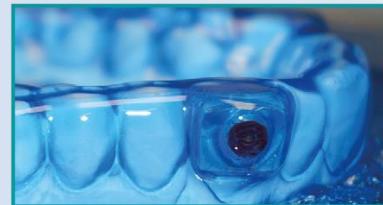

**15.** ... finger back and forth. Do not stay too long at one place, **hot!** The result is a plane occlusal surface.



**16.** Take the models out of the unit and roughly cut out before removing the splint from the model (fissure bur > 20 000 rev./min.).



**17.** Uncover all spacers before taking the splints off the model. Thereto, **carefully** grind through the plate until the coloured marking on the spacers is just abraded, ...

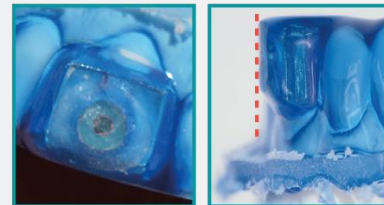

**18.** ... **not more and not less!** (tungsten carbide bur > 20 000 rev./min.) **Ensure a plane surface.** Take the splints off the models.

continue at finishing

## Fabrication

## Finishing



**1.** Cut the final form with the HSS twist drill (> 20 000 rev./min., without pressure), leave sufficient material (min. 2 mm) around the fixation points.



**2.** Grind the borders with the tungsten carbide bur (>20 000 rev./min.).



**3.** Smooth the borders, grinded areas with Lisko-S, narrow zones and interdental spaces with Liskoid (both 10 000 rev./min.).



**4.** Polish Erkodur with polishing agent for plastics (polishing set, 110 878).



**5.** Erkoloc-pro can be shined with the hot air burner (177 540), thereby only work on the model and do not heat the holes for the anchors (risk of deformation).



**6.** Press spacers inwards out of the splint (for ex. with the Lisko-S mandrel shank), it might be necessary to firmly press.



**7.** Remove the insulating/shrinkage compensation foil.



**8.** Cut the anchors as shown on the picture.



Take the anchors at the retaining lip and ...



**9.** ... put them into the splint as replacement for the spacers.



**10.** Firmly press into position, if necessary, also carefully with suitable pliers.

# Fabrication

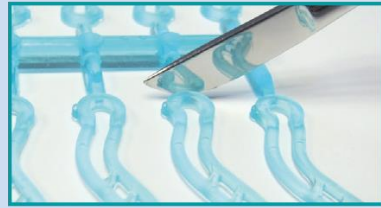

**11.** Cut the connectors, always opposing connectors have the same length.

## Choose the connector length:

The connectors are exchangeable, for example if more protrusion is necessary for a sufficient effect.

The shorter the connector is chosen in comparison to the measurement, the larger is the advancement of the lower jaw.

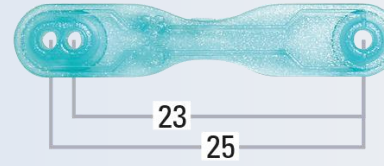

**without** construction bite: measured, 23 / 25 mm

connector, 22 / 24 mm

**with** construction bite: measured, 23 / 25 mm

connector, 23 / 25 mm

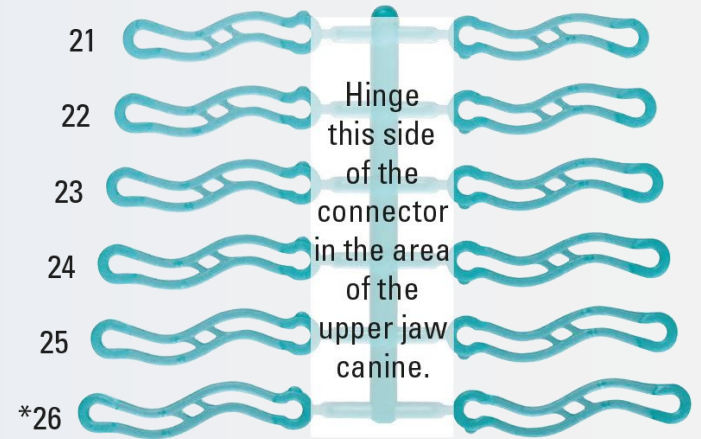

\*The 26 mm connector is used when the patient despite of bite taking does not tolerate the advancement.

# Finishing



**12.** Remove sharp cutting edges!



**13.** Hinge the connectors into the long slot and pull it into its final position.



**14.** Observe upper jaw canine side of the connector.

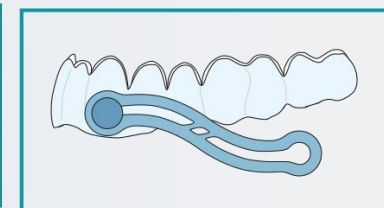

Upper jaw, obligatory run of the connectors, on the left and right.

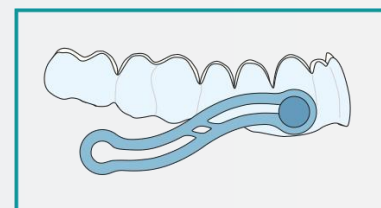

**15.** Hinge the connector into the other splint. Please check correct positioning of the splint. In case of propulsion movements (feed) the ...

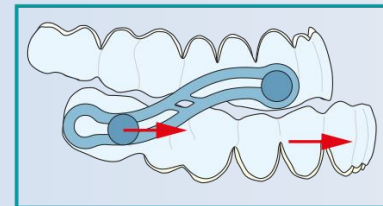

**16.** ... connector shall slide out of the anchor of the lower jaw, see picture, if not, hinge the connector about-face.

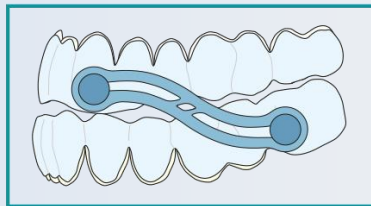

Connected splints, obligatory run of the connectors, on the left and right.

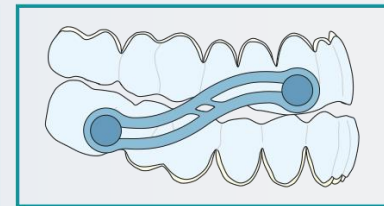

**17.** Now cut the retaining lips off the anchor. Finished.

## Fabrication

Correct fixation of the connector

The sliding end of the connector is always placed at the lower molar area.

The fixation as shown in the upper picture is correct.

The fixation as shown in the lower picture is wrong, it may cause pain at the gingiva during sudden protrusion movements.

Also there is a risk that the connector may jump out of the anchor, due to sideward moving when sliding on the gingiva.

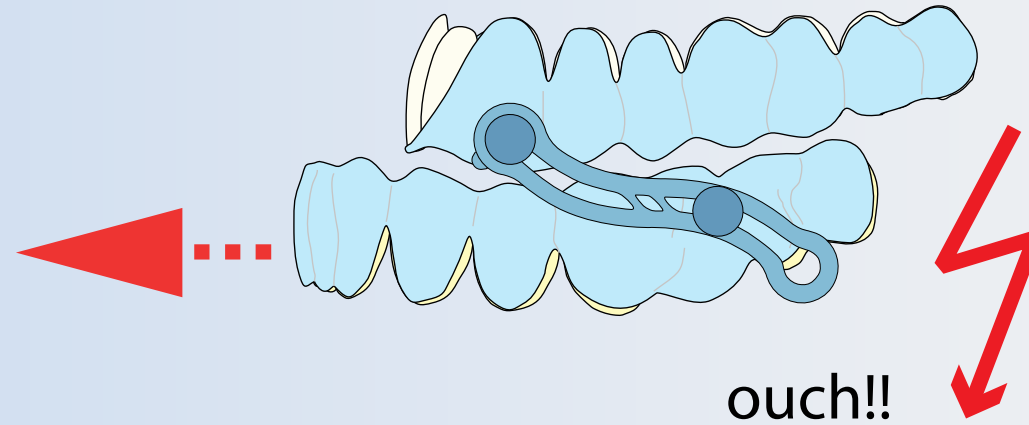
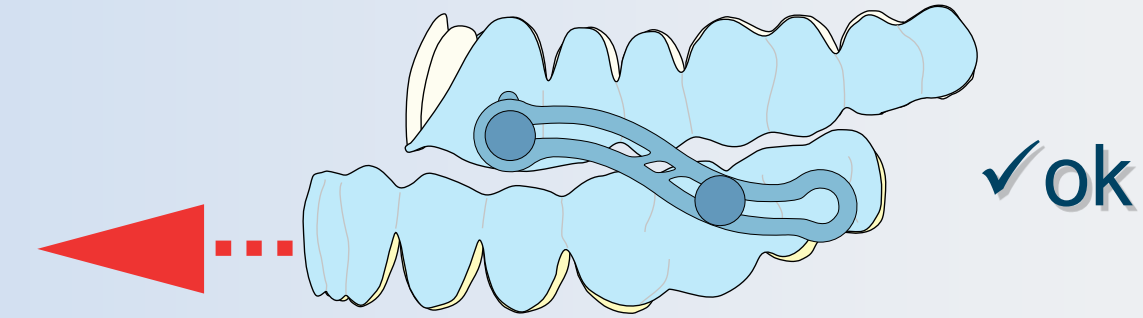

Thank you for your attention.



# PLAY SAFE<sup>®</sup>

Individually  
manufactured  
sportsmouthguards

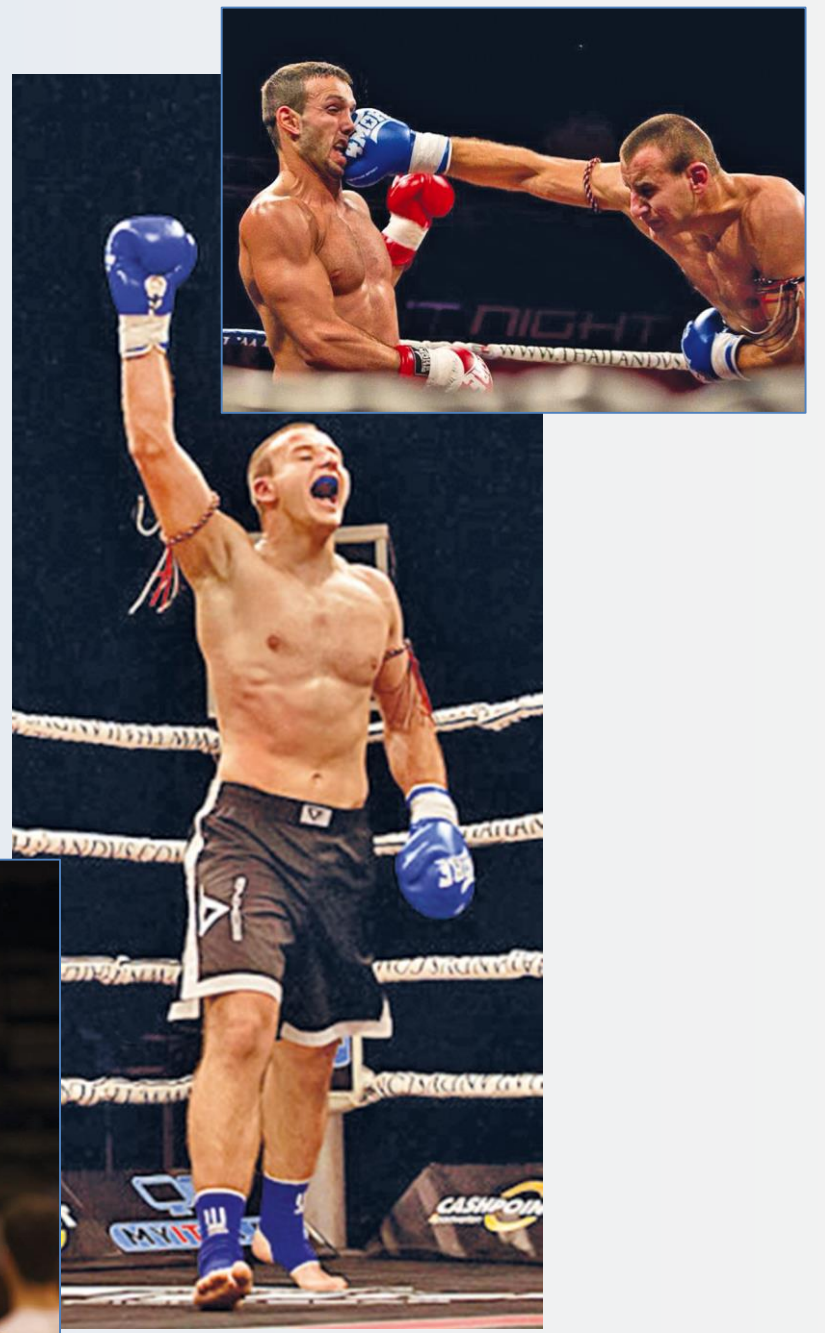

# Playsafe sports-mouthguards

Play hard, play safe!

Protection

Safety first!

Prevention



**PLAY SAFE**®

Laminated sports-mouthguards,  
two or three layers.



**PLAY SAFE**® *triple*

Prelaminated sports-mouthguards,  
three layers.





## Playsafe sports-mouthguards

- Choose your preferred design and determine where it should be applied. Mostly at the visible surface during wearing. Because of the bite changing it is not recommended to apply designs at the occlusal surface.

- Erkodent needs the data of the design as .jpg or .pdf. The print will be effected immediately and sent by letter to the client.

- Please check our web page for further information.

[www.erkodent.com](http://www.erkodent.com)

**PLAYSAFE®** 4 u



Completely free individualisation of the Playsafe sports mouthguard types.



# Dental injuries

## 1. Crown fracture

Demolition or chipping without damage to the pulp

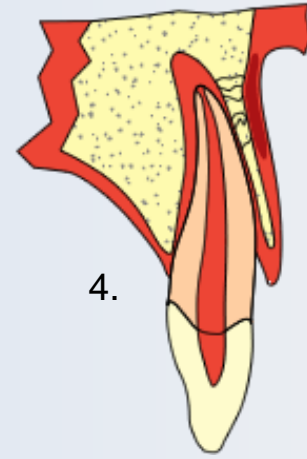
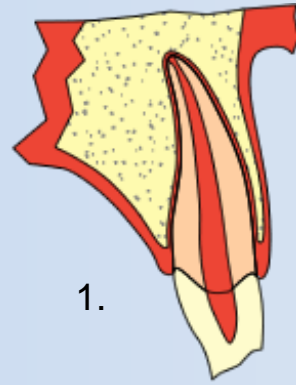

## 2. Crown fracture with opened dental pulp

Demolition or chipping without damage to the pulp

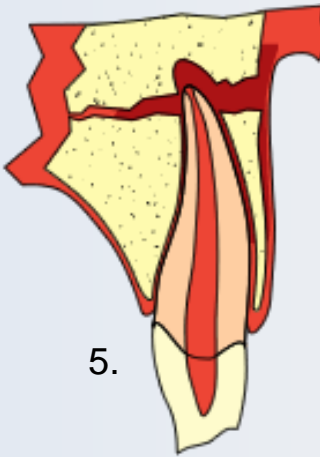
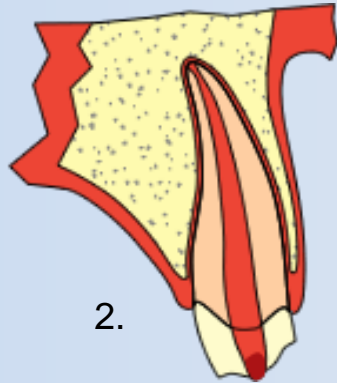

## 3. Root fracture

## 4. Extrusion injury

caused by a blow to the jaw bone

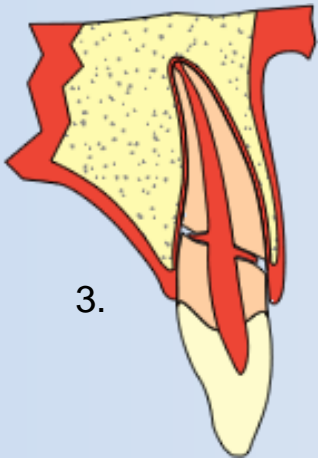

5.



## 5. Jaw fracture

caused by extremely powerful impacts

(bottom right image: horseshoe)

# Sports-mouthguards classification

## 1. preformed stock-mouthguard

**Advantage:**

- Cost

**Disadvantage:**

- Not adaptable
- Loose in the mouth
- Overload for prominent teeth
- Danger of breath obstruction

Nothing is better!!



1. preformed stock-mouthguard

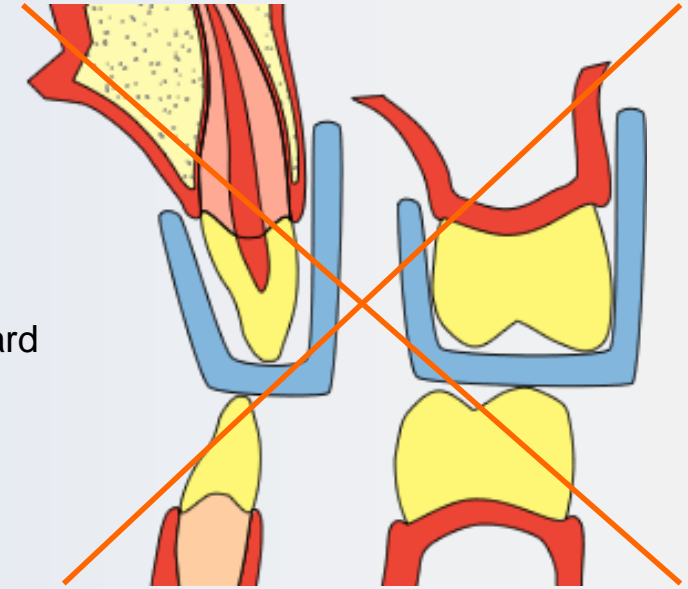

## 2. boil & bite mouthguard

**Advantage:**

- Cost
- Easy to get
- **Disadvantage:**
- Loose in the mouth
- Not enough occlusal thickness (bitten through while adapting)
- Only absorption, no power distribution

Better than nothing



2. Boil & bite mouthguard

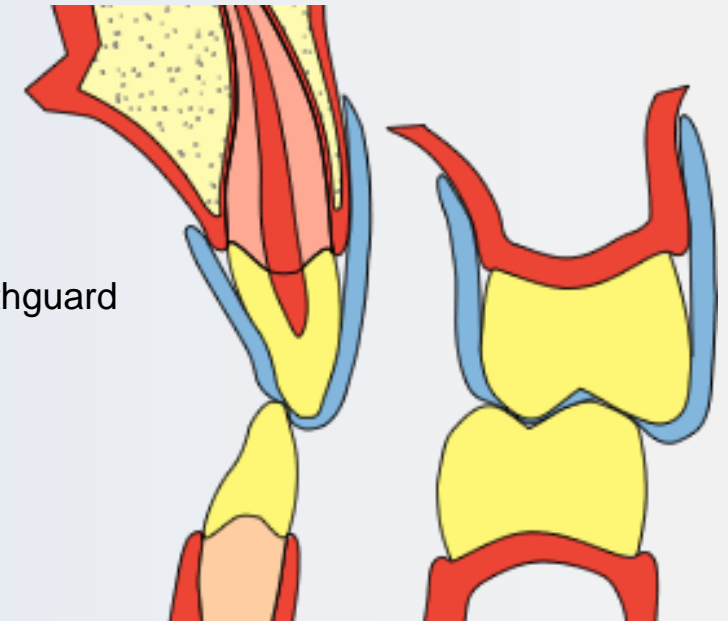

## Sports-mouthguards classification

### 3. lab-made, individualized single-layer mouthguard

#### Advantage:

- Good fit
- Power absorption and distribution

#### Disadvantage:

- Not enough incisal thickness
- Limited power distribution
- Cost
- Availability



1. lab-made, individualized single-layer mouthguard

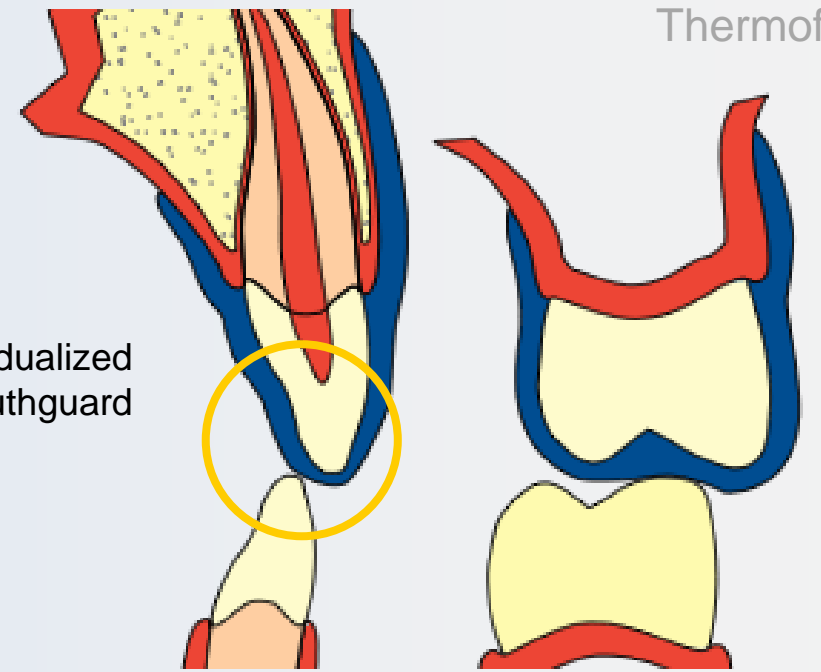

### 4. lab-made, individualized, laminated mouthguard

#### Advantage:

- Good fit
- High power absorption and distribution
- Best material proportion
- Can be reinforced
- Can be readapted(hot water)

#### Disadvantage:

- Cost
- Availability

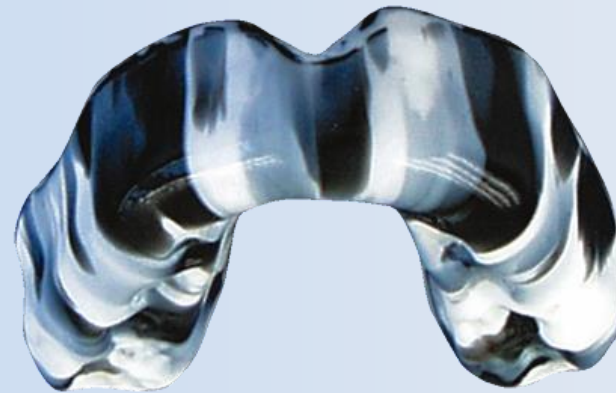

2. lab-made, individualized, laminated mouthguard

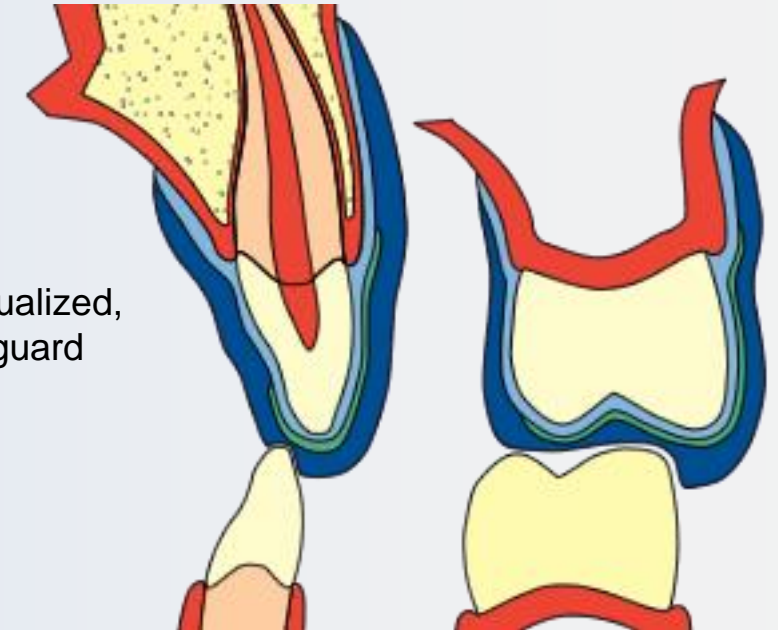

# Sports-mouthguard extension

A Playsafe mouthguard covers the jaw bone as far as possible (a).

It covers the teeth including the first molar (b).

The bite opening should be 4 – 5 mm at the incisal point (c).

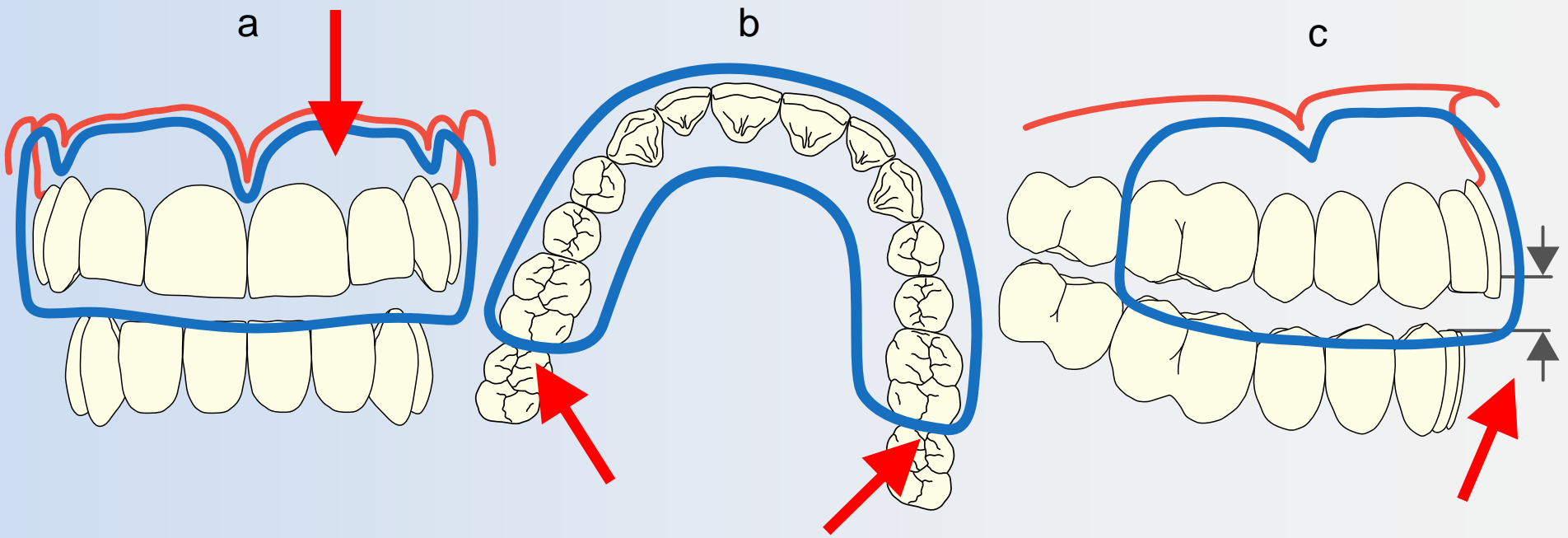

## Playsafe sports-mouthguards

Why laminate?

Incisal thinning can be reduced by laminating.

The incisal thickness will increase up to 30 % when using two 2-mm foils, one after the other, instead of one 4-mm sheet.

This effect will reinforce the guard by approx. 20 %.

Prelaminated materials behave during thermoforming as single layer foils. The incisal thickness will not improve.

It is different with the prelaminated **Playsafe triple**. Thanks to a special production step, the incisal thickness will improve.

**PLAY SAFE**<sup>®</sup>

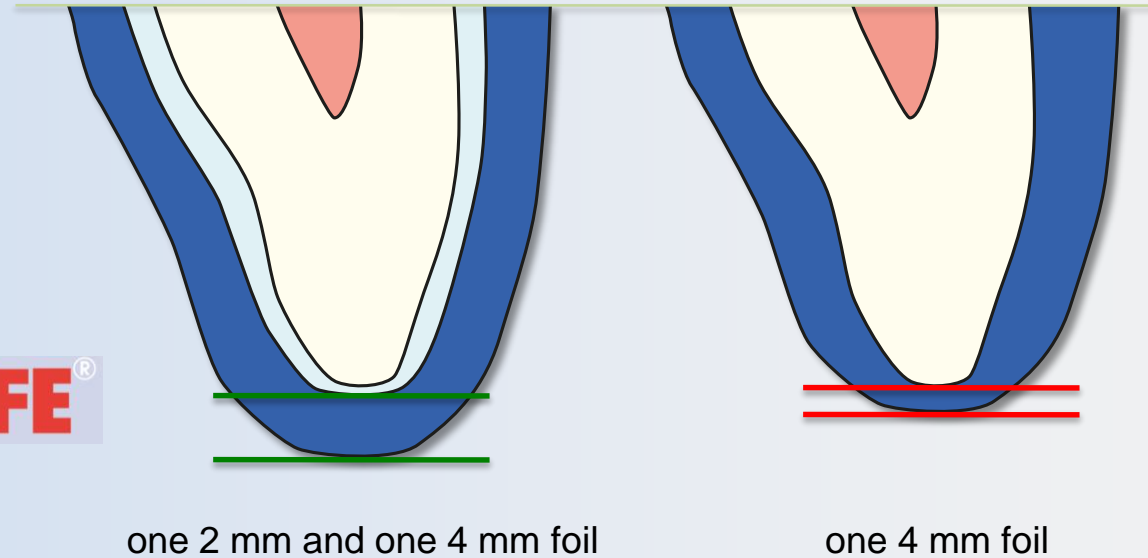

**PLAY SAFE**<sup>®</sup> *triple*

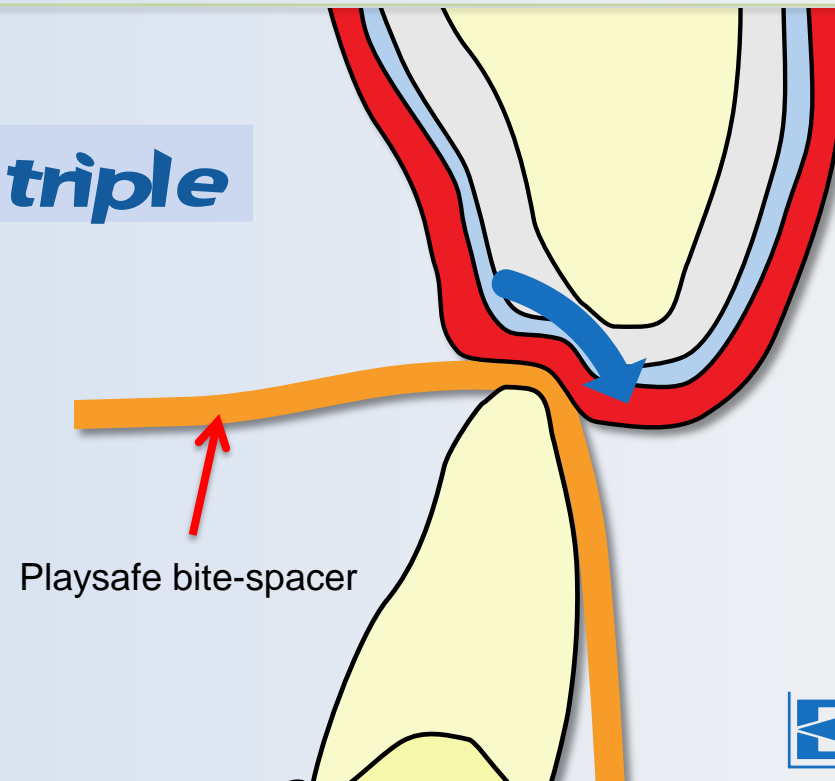

# Playsafe sports-mouthguards

Testing:

Deforming load (10 N), this test measures the resistance against deformation (a).

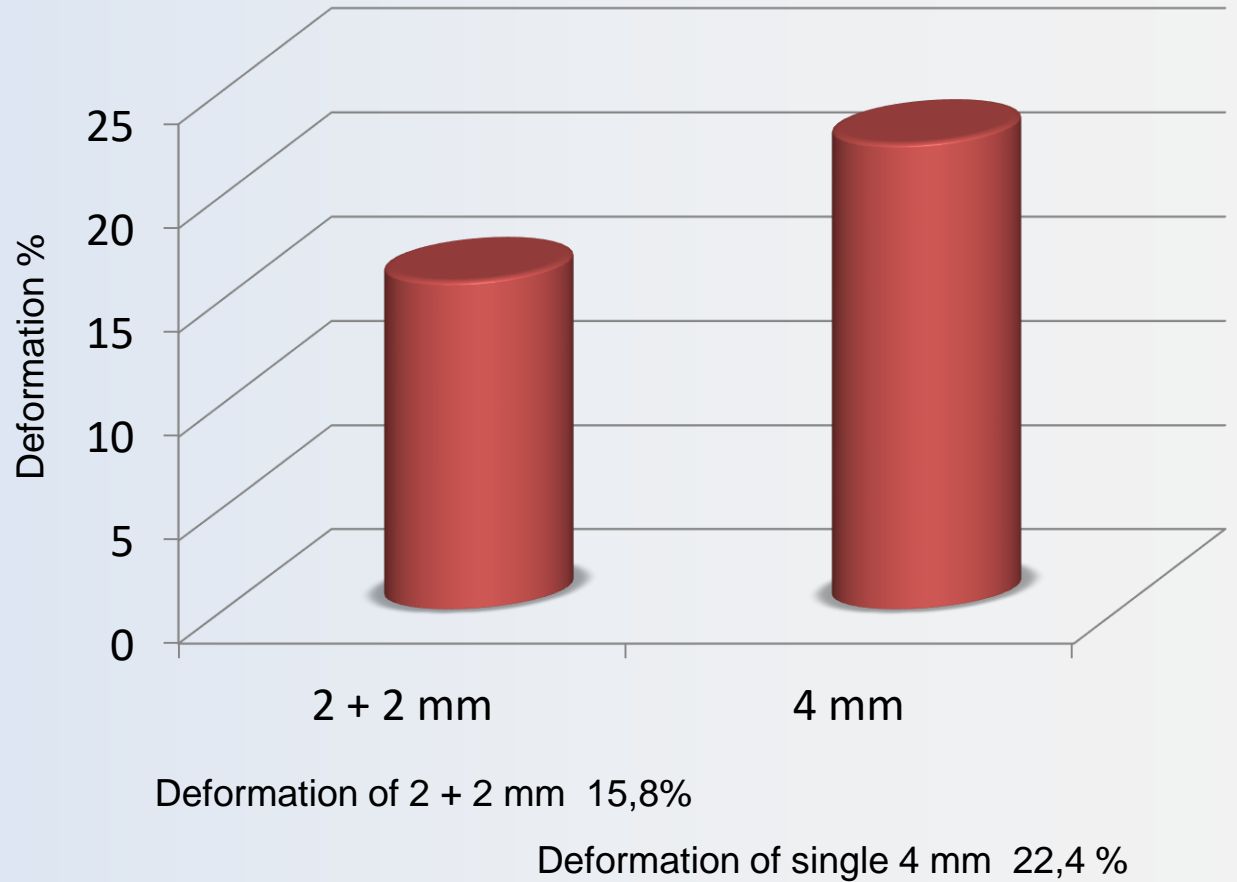
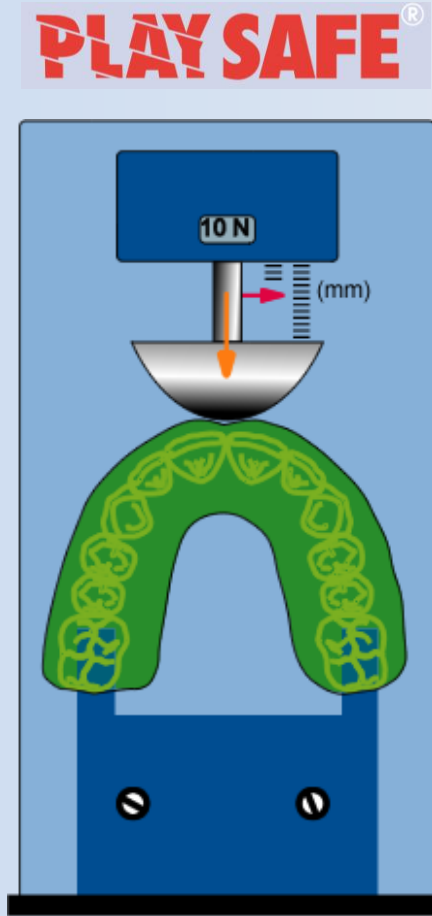

Playsafe types:



Playsafe light

Playsafe medium

**Playsafe light, 2 layers**

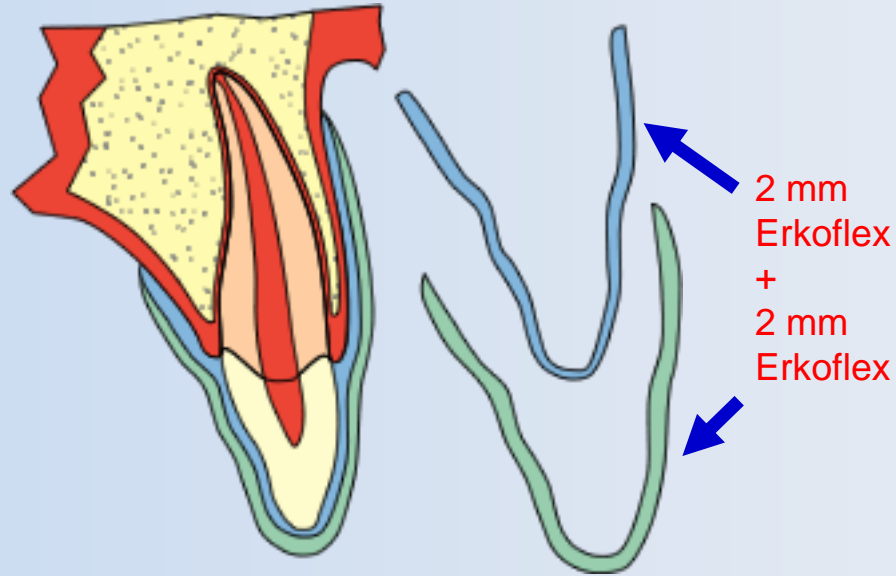

Interdental collision protection for sport activities where integral helmets are worn (f. ex. motocross). Alternatively to Playsafe medium in case of cramped oral situation. Light can be reinforced with a hard layer (see next page).

**Playsafe medium, 2 layers**

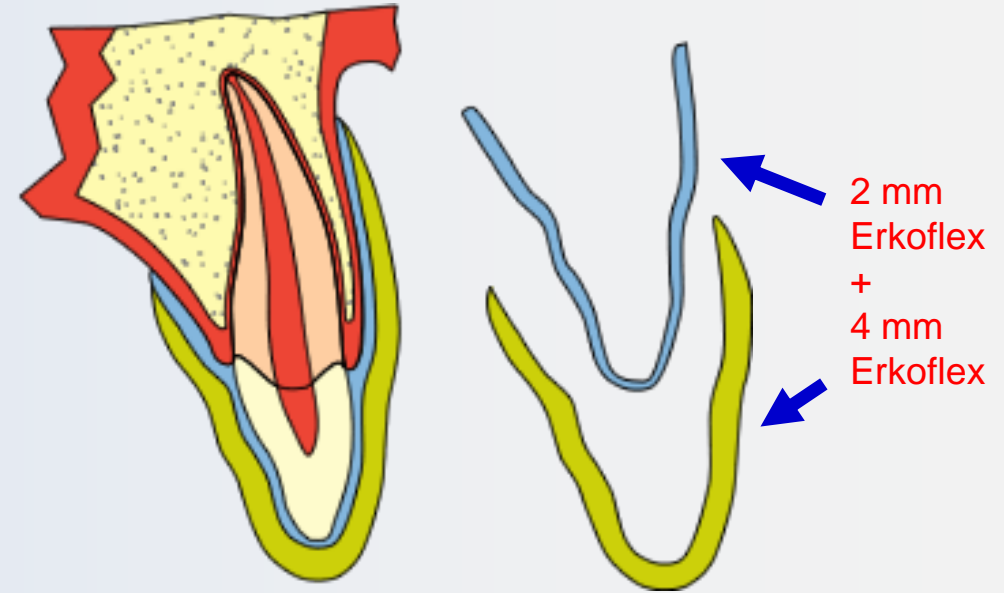

Boxing, judo, wrestling, soccer...

Prevents collisions with wider surface (boxing gloves).



Playsafe types:



Playsafe heavy-pro

Playsafe light-pro

Playsafe heavy-pro and Playsafe light-pro, 3 layers

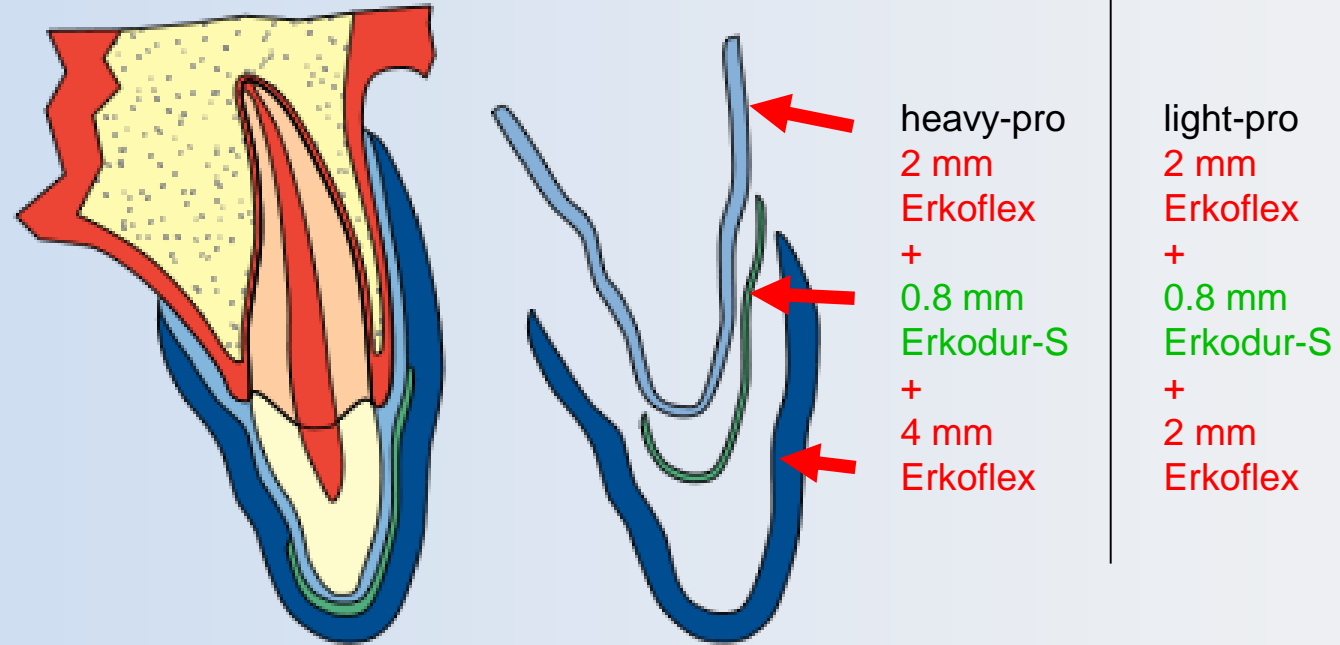

Ice hockey, field hockey, squash, kickboxing. Prevents hard collisions with small surface (rackets). Highest power distribution rate.

Recommendation:  
Playsafe light-pro in case of cramped oral situation (f. ex. adolescents, ladies)

## Playsafe types:

**PLAY SAFE<sup>®</sup> triple**

The Playsafe triple plate is already three-layered, outside soft and in between hard.

Available in two thicknesses:

Playsafe triple, 5.5 mm  
Playsafe triple-light, 4.1 mm

Thermoform once and imprint the articulation surface in a tricky way, allow to cool off and elaborate, if desired, also apply the label, finished.

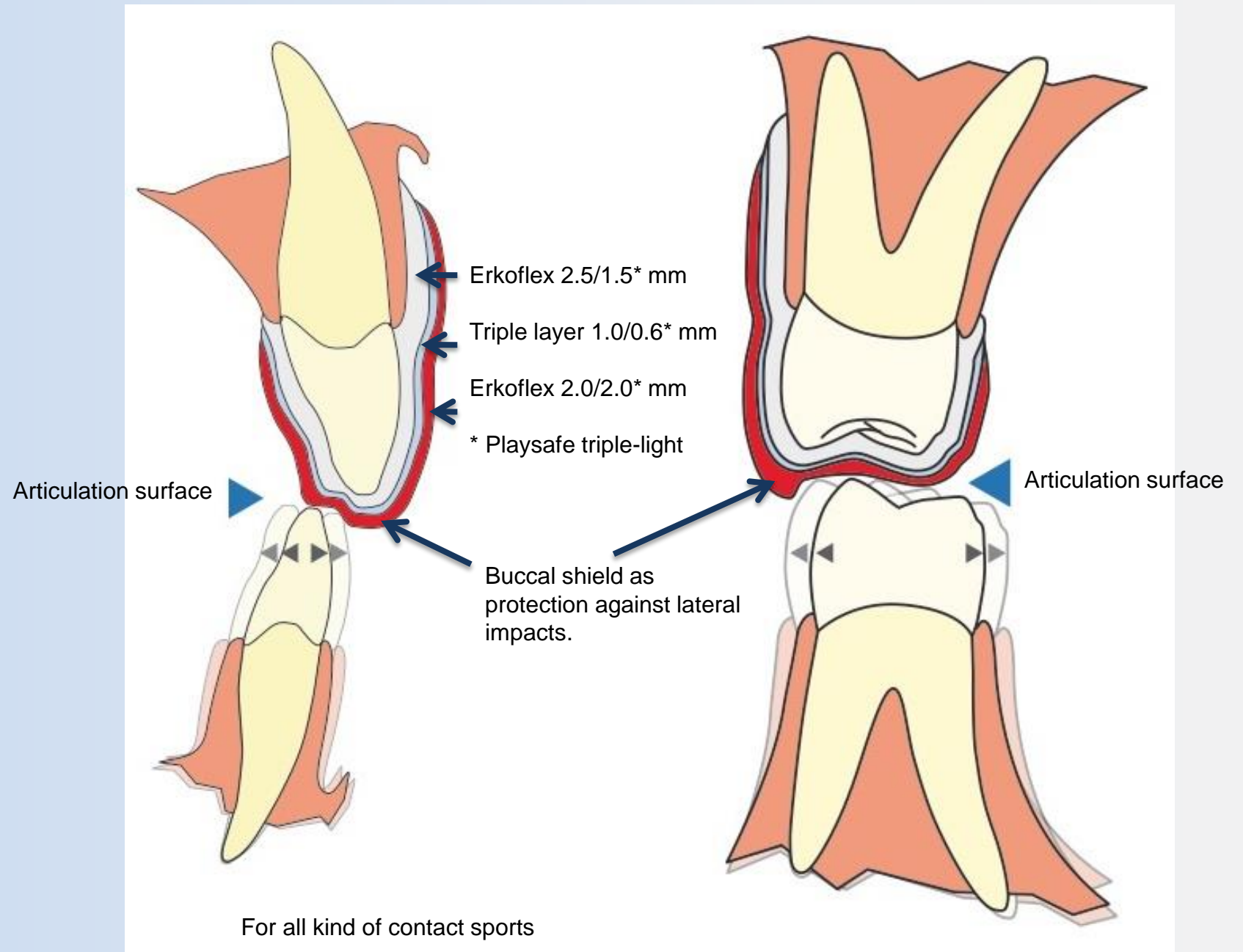

# Playsafe sports-mouthguards

## Testing:

Pendulum test (various weights), this test measures absorption and power distribution (%) as well as the travelling of the power through the dental arch.

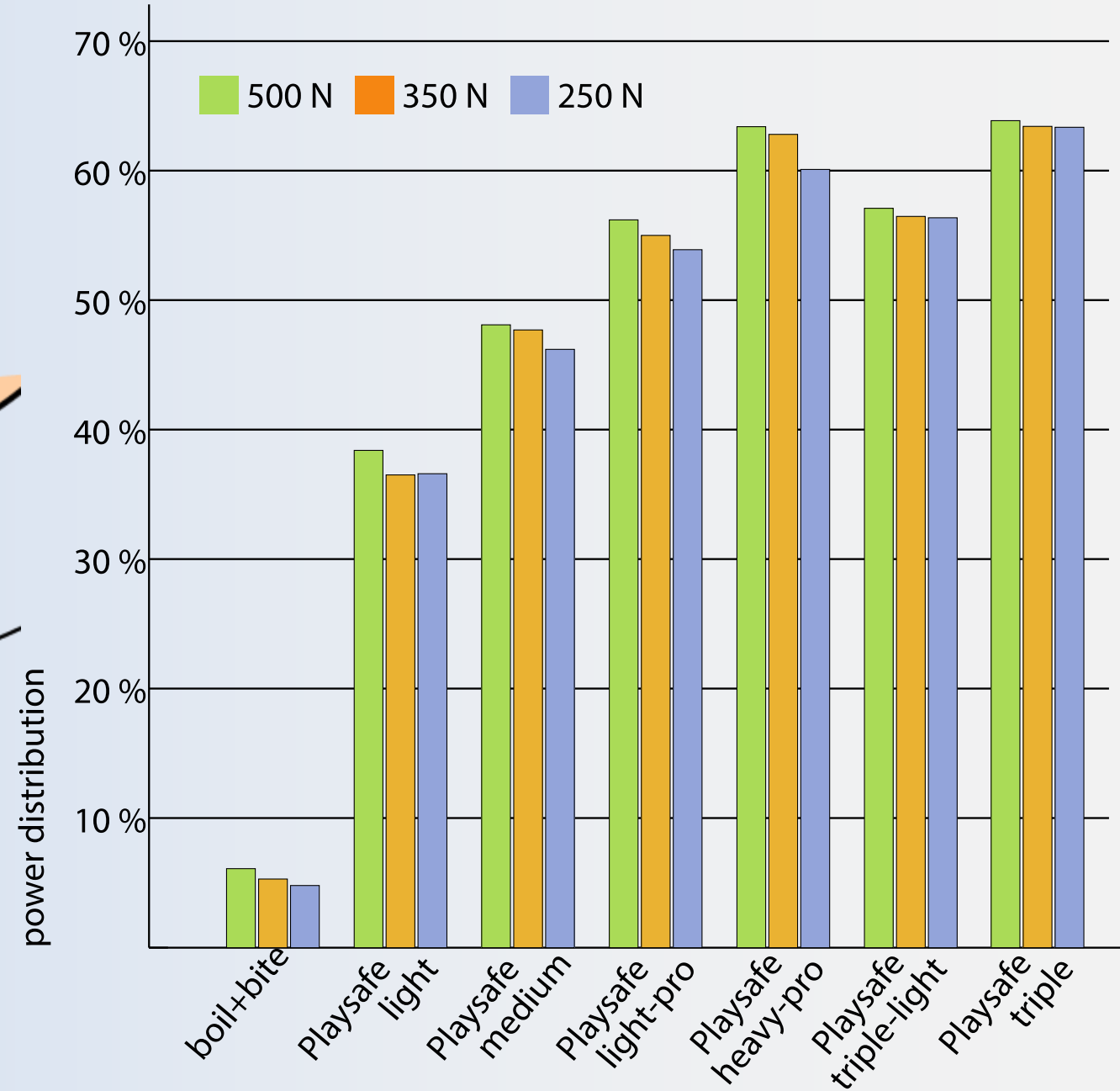
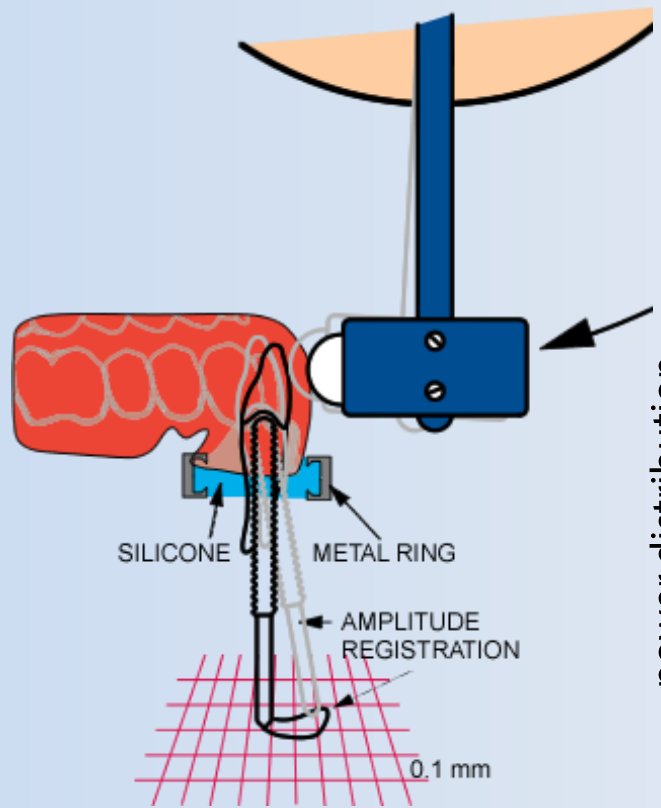

# Playsafe sports-mouthguards

Testing:

Pendulum test and high speed camera.

Artificial teeth in soft silicone without significant resistance. Thus, a statement about power distribution and deformation can be made.

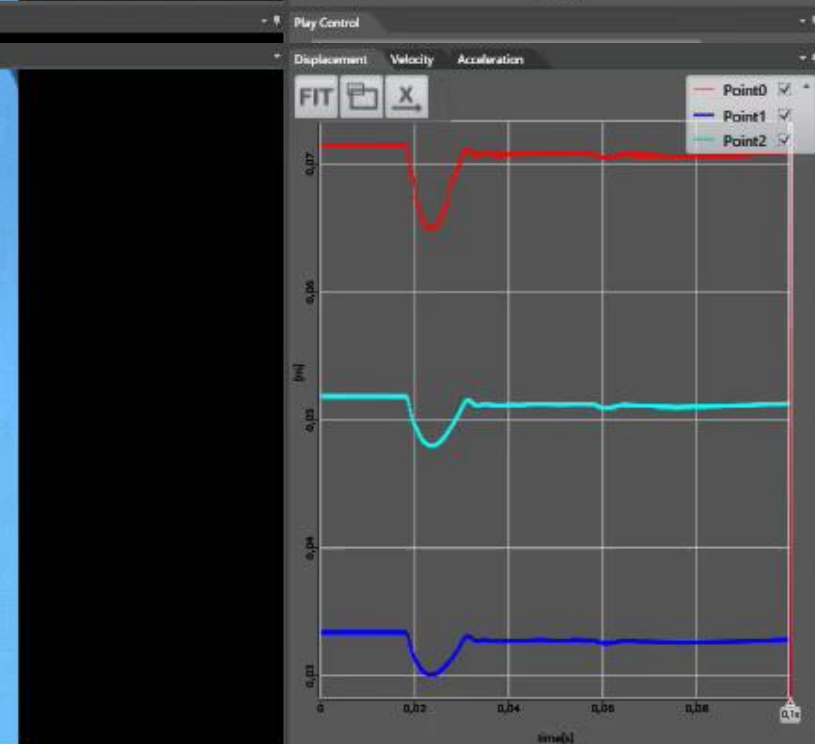
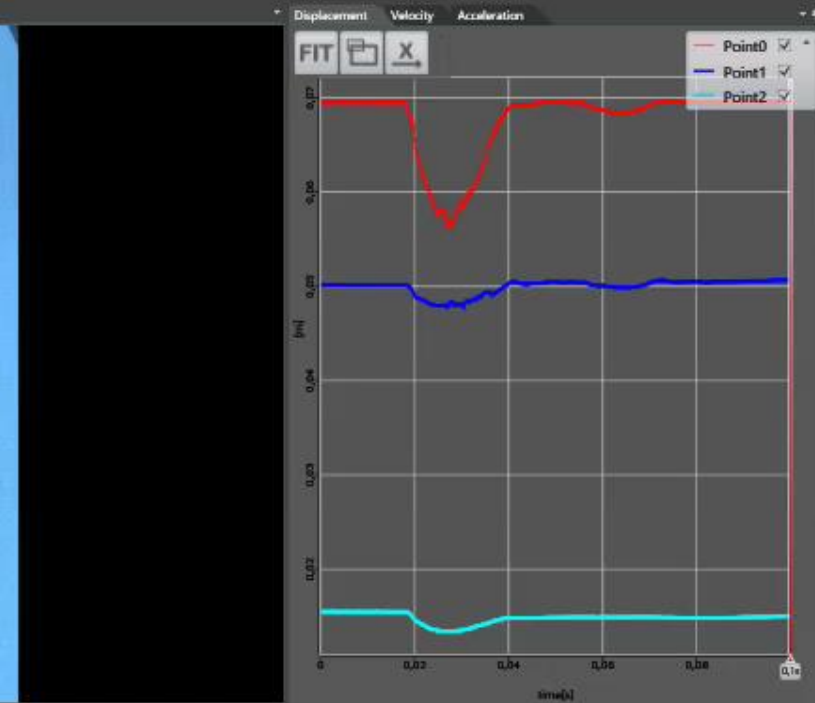

# Playsafe sports-mouthguards

## Testing:

Retention test shows if the mouthguard has enough retention to fit safely.

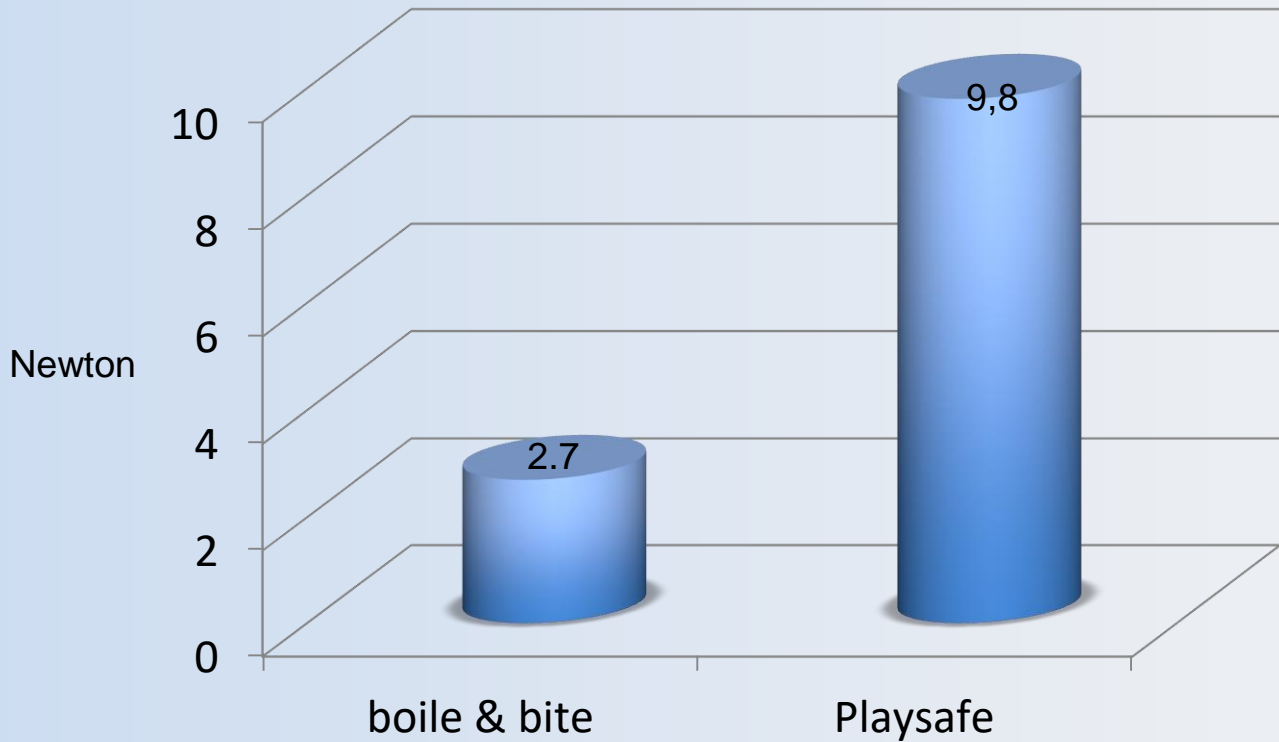

## Playsafe when wearing brackets?

For a short time of wearing Playsafe may also be fabricated on brackets.

**Only Playsafe, not Playsafe triple.**

1. Impression taking without wiring
2. Repair model in the area of the brackets
3. Block brackets and wire with Erkogum
4. Fabricate Playsafe, integrate heavy-pro reinforcement palatinal

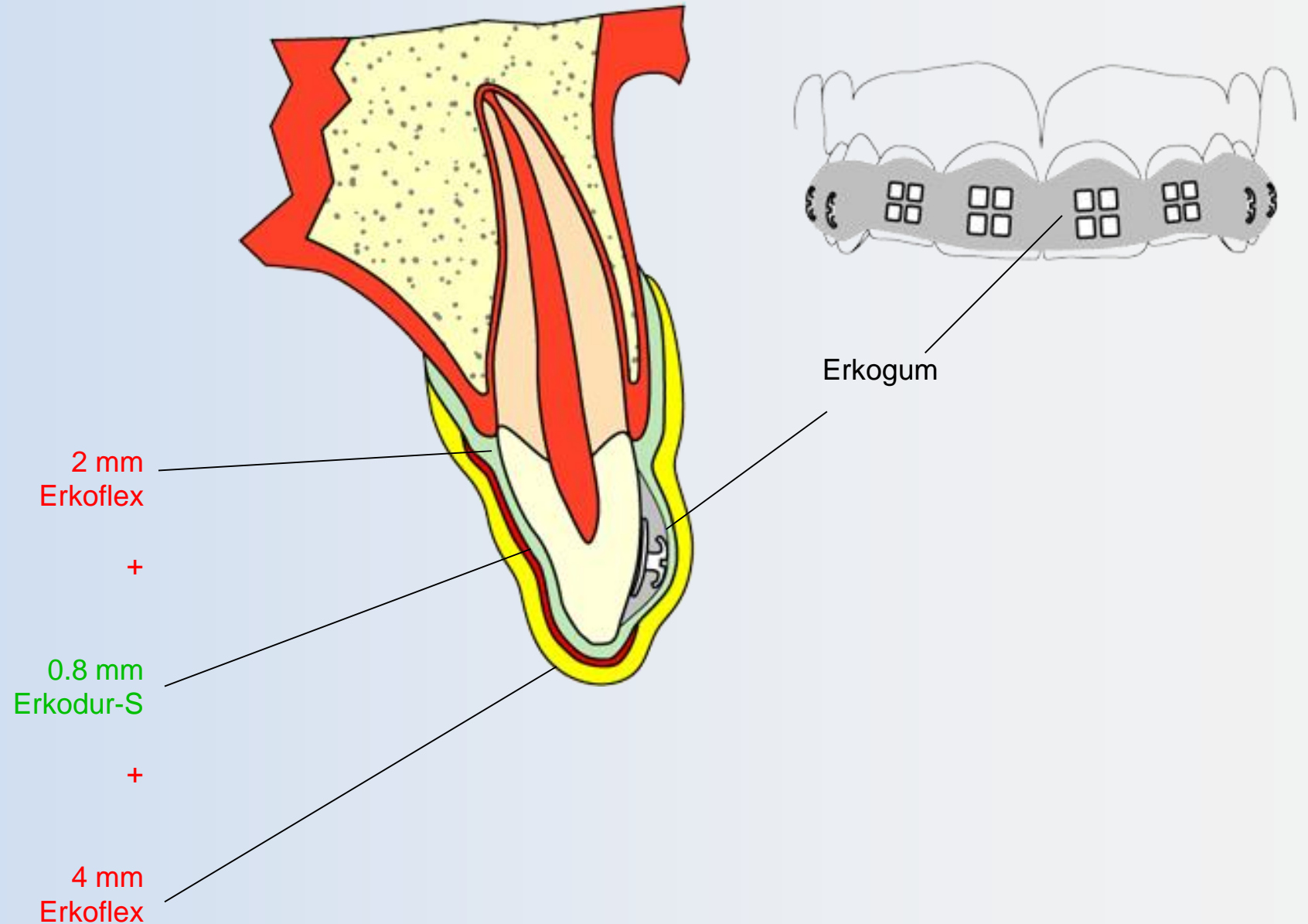

# Playsafe sports-mouthguards

Playsafe mouthguards fulfill all requirements to the highest class of mouthguards.

Highest load absorption and distribution, lowest risk of ingestion, precise fit. Ultimate protection of middle face injuries, helps to prevent neck injuries and concussion.

Comfortable to wear, easy to speak and breathe.

Playsafe and Playsafe triple mouthguards can be manufactured in a lot of different colours.

15 plain colours and 10 freestyle colours are available for each Playsafe type.

In addition it is possible to fabricate a 2-, 3- or 4-coloured mouthguard out of the colours 1-15.



**PLAYSAFE**

**PLAYSAFE triple**

2-, 3- or 4-coloured sports-mouthguards





**PLAY SAFE**® triple

Playsafe triple

Comparison of Playsafe triple and Playsafe heavy-pro



Playsafe heavy-pro

**PLAY SAFE**®



## Structure of Playsafe triple:

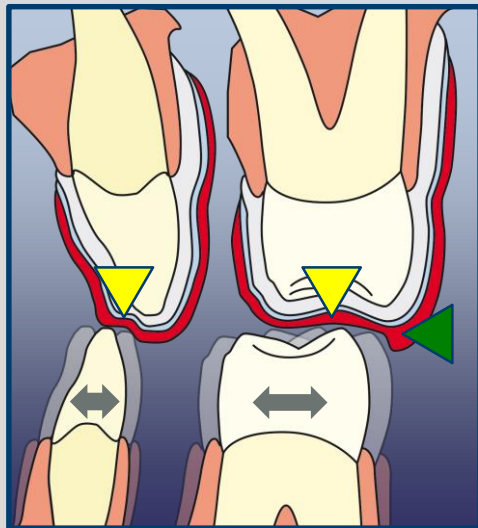

Thermoform once a Playsafe triple foil and get the buccal shield ◀ as protection against lateral impacts and an articulation surface ▼ for comfortable freedom ↔ for the lower jaw.

Playsafe triple foil 5.5 mm, prelaminated:

Erkoflex 2.5 mm, soft. • \*Triple layer 1.0 mm, hard • Erkoflex 2.0 mm, soft

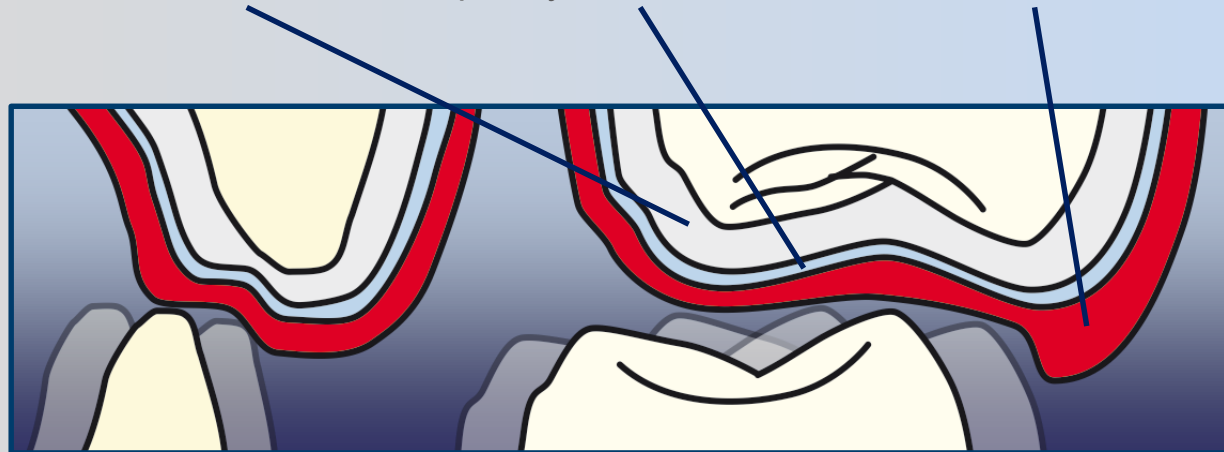

\*Triple layer, COC (cyclo-olefin-copolymer)

## Structure of Playsafe heavy-pro:

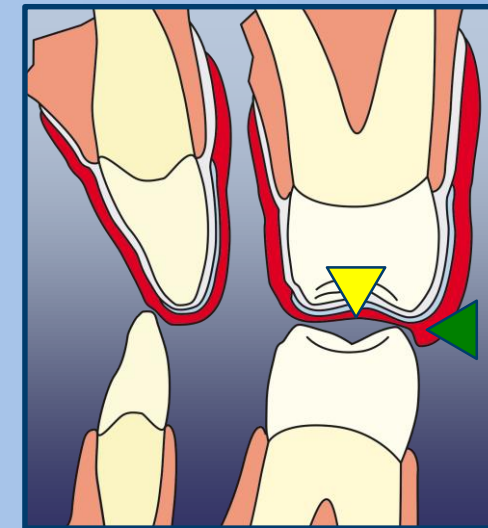

Thermoform one layer after the other. First Erkoflex 2.0 mm, soft, second Erkodur-S 0.8 mm, hard, third Erkoflex 4.0 mm, soft. The buccal shield ◀ and the articulation surface ▼ is ground afterwards.

Playsafe heavy-pro total foil thickness 6.8 mm

Erkoflex 2.0 mm, soft • Erkodur-S 0.8 mm, hard. • Erkoflex 4.0 mm, soft

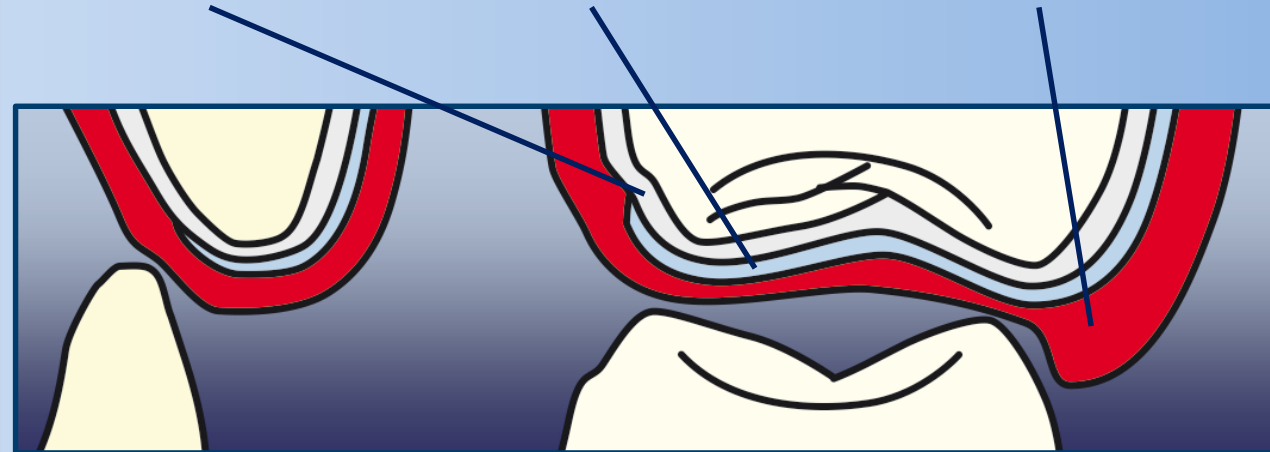

Comparison of weight, volume and incisal thickness at tooth 21

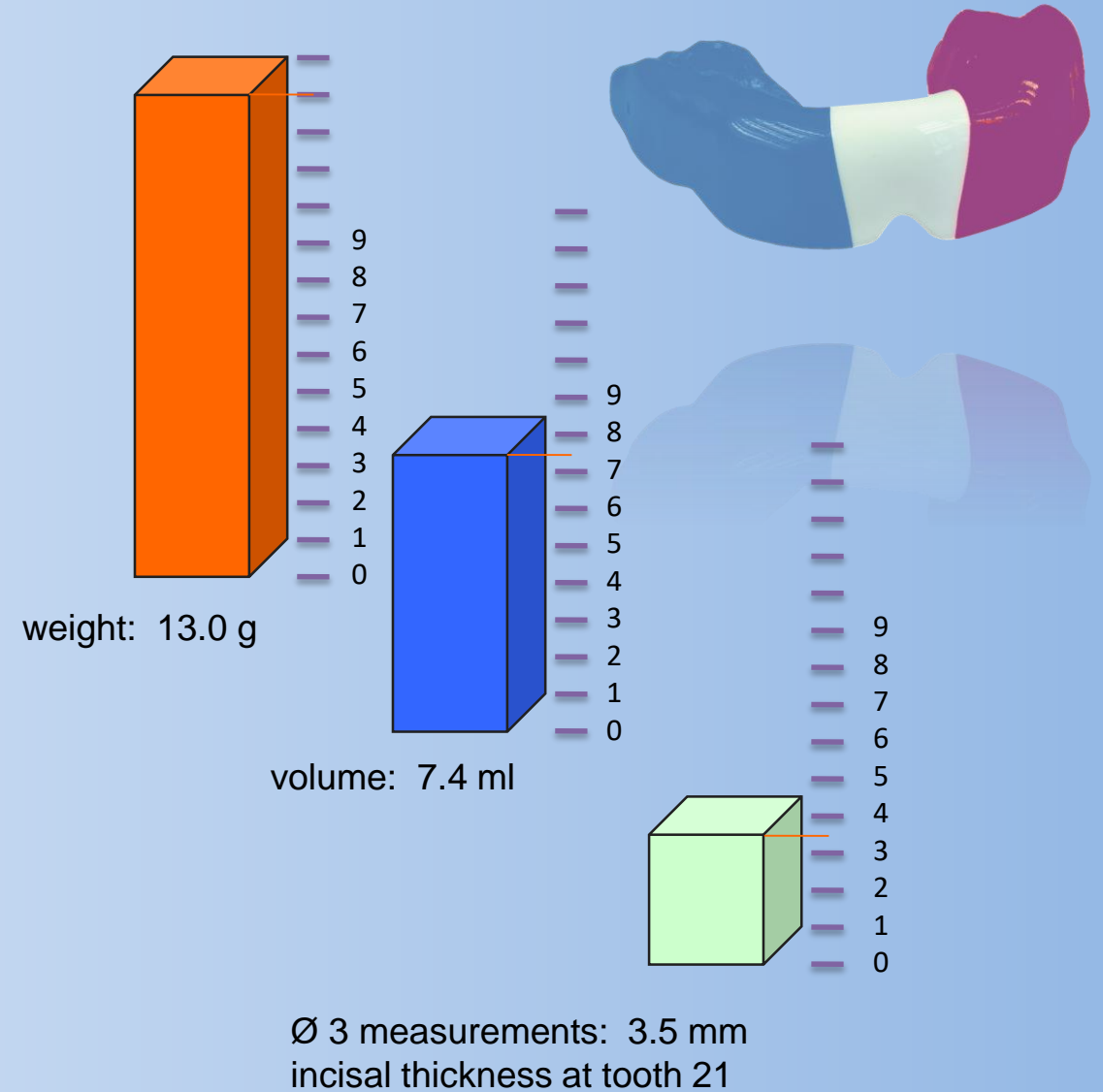
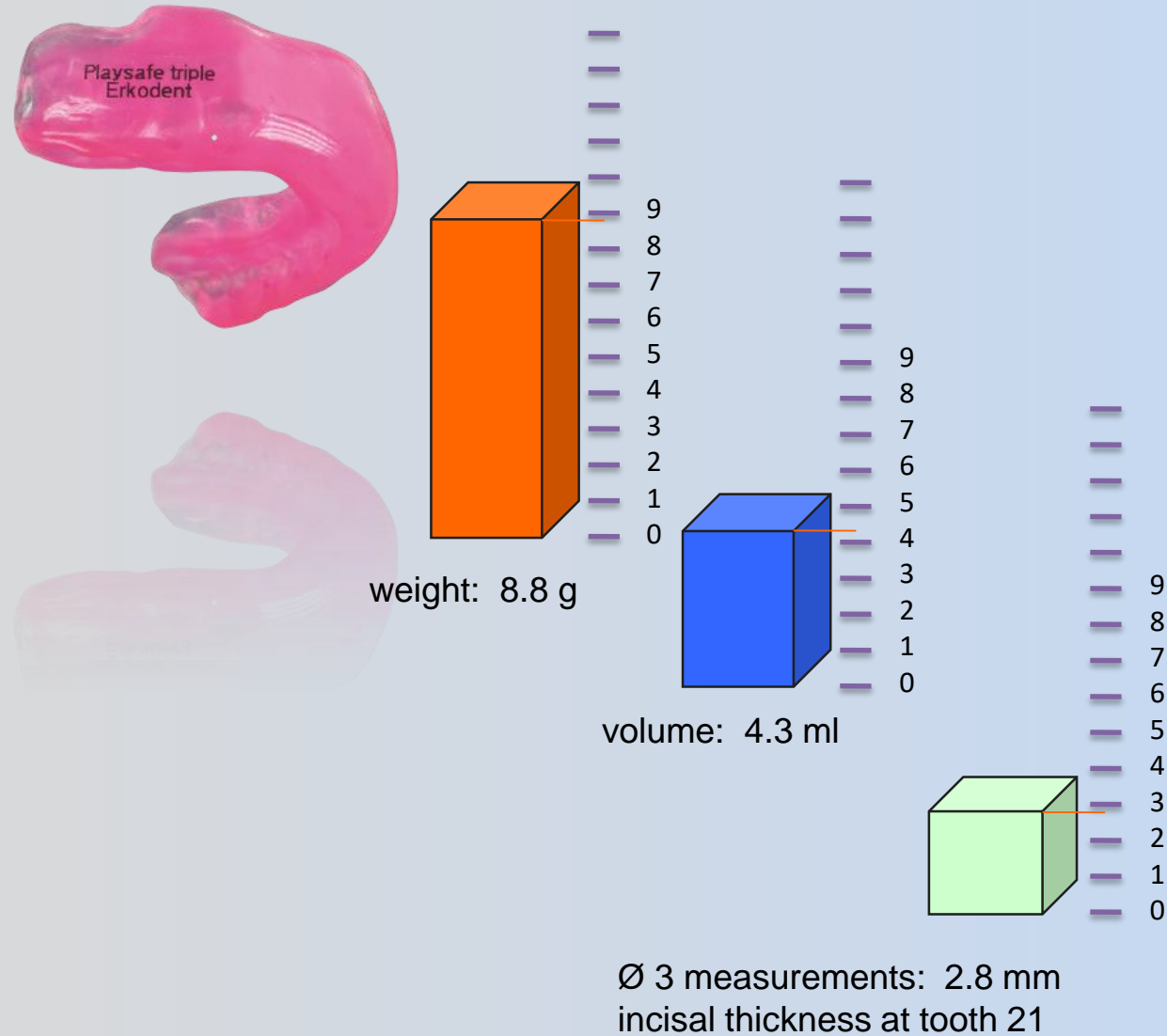

Comparison of deformation of 1.25 and 2.0 mm

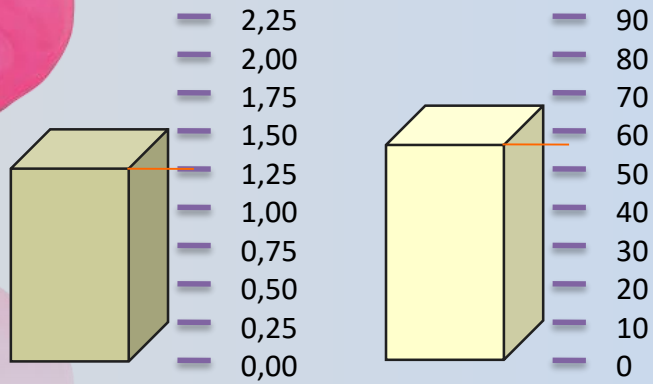

Deformation 1.25 mm • Power 57 N

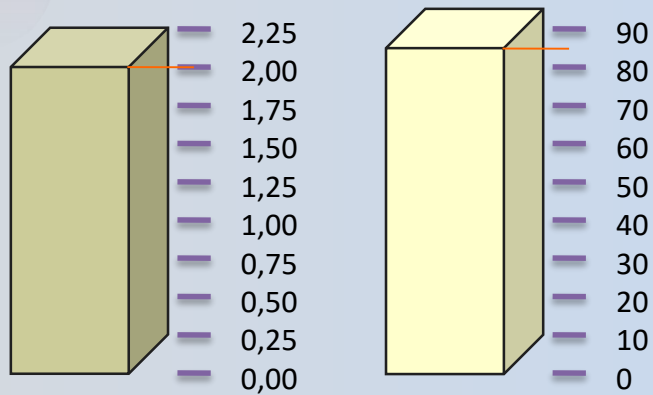

Deformation 2.0 mm • Power 85 N

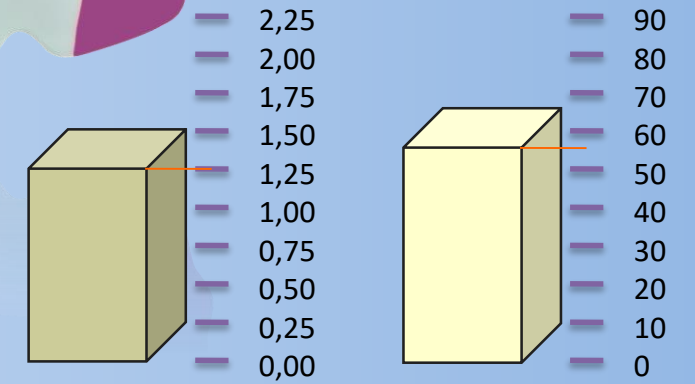
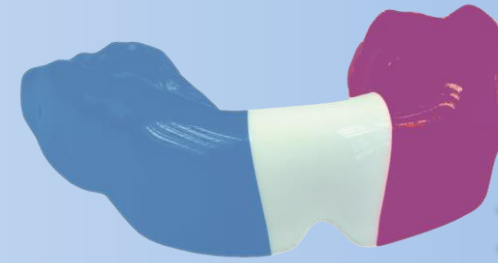
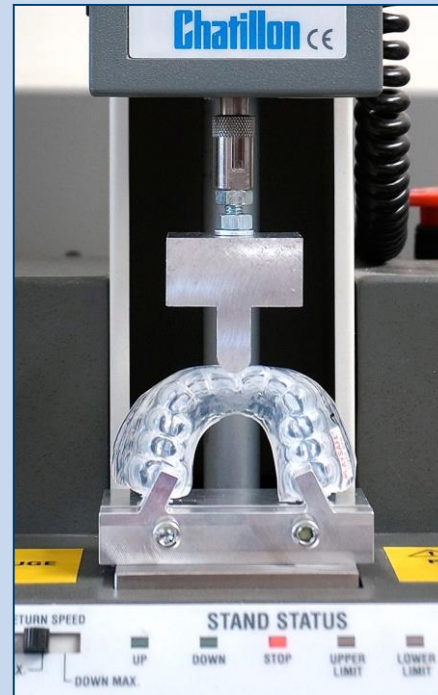

Deformation 1.25 mm • Power 56 N

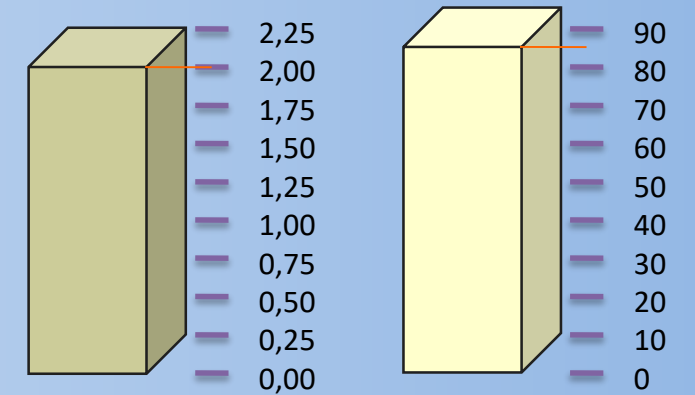

Deformation 2.0 mm • Power 86 N

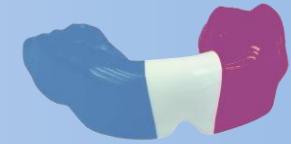
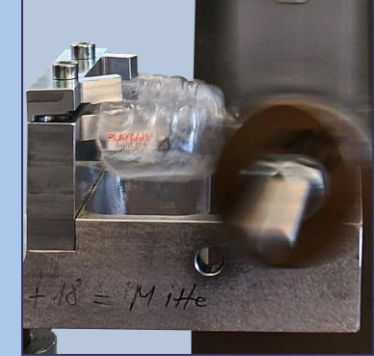
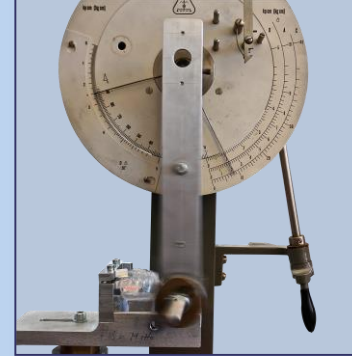
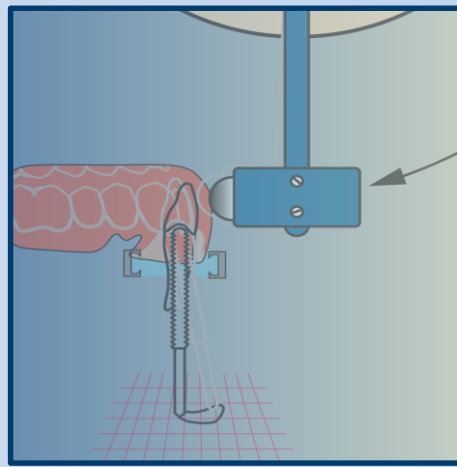

The pendulum test measures the deformation at the teeth 21, 24 and 26. Power distribution and absorption can be calculated.

Comparison of deformation teeth 21, 24, 26  
Ø of several measurements

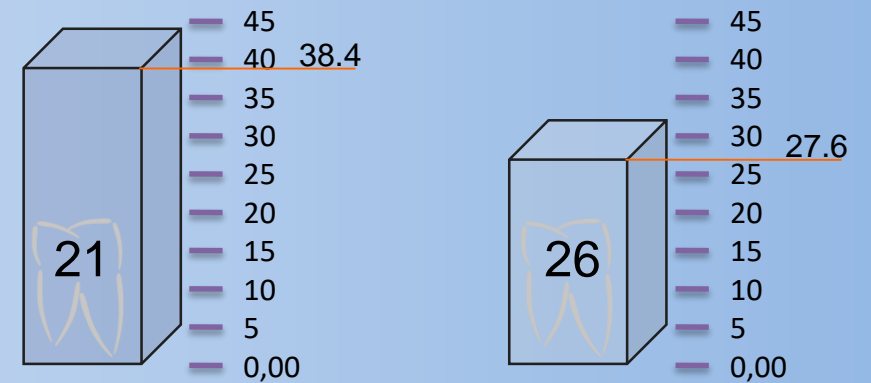
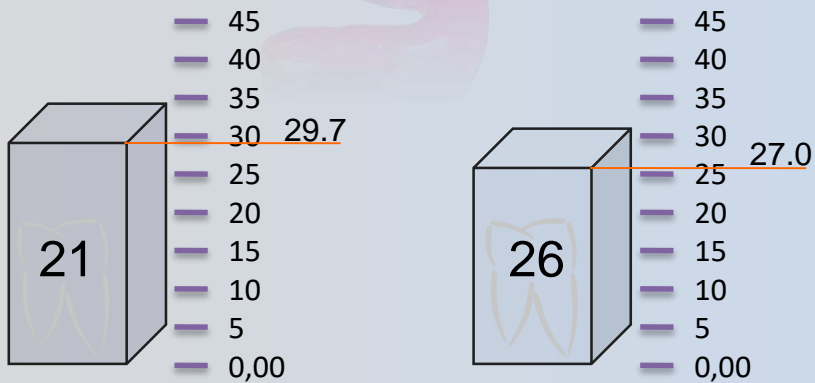

Deformation in mm\* • Pendulum weight 1.5 Nm (637 g)

Deformation in mm\* • Pendulum weight 1.5 Nm (637 g)

\* to better distinguish the deflections were multiplied by virtual extension of the roots.

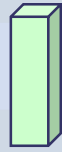

Comparison summary

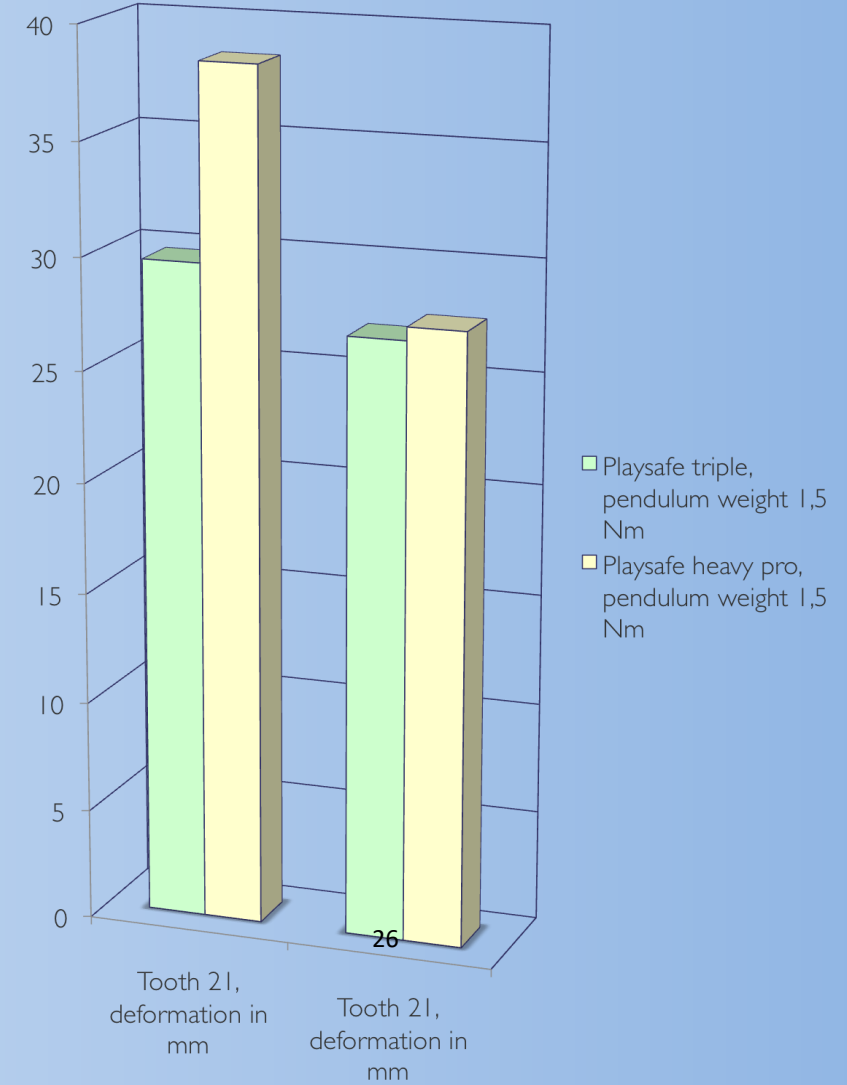
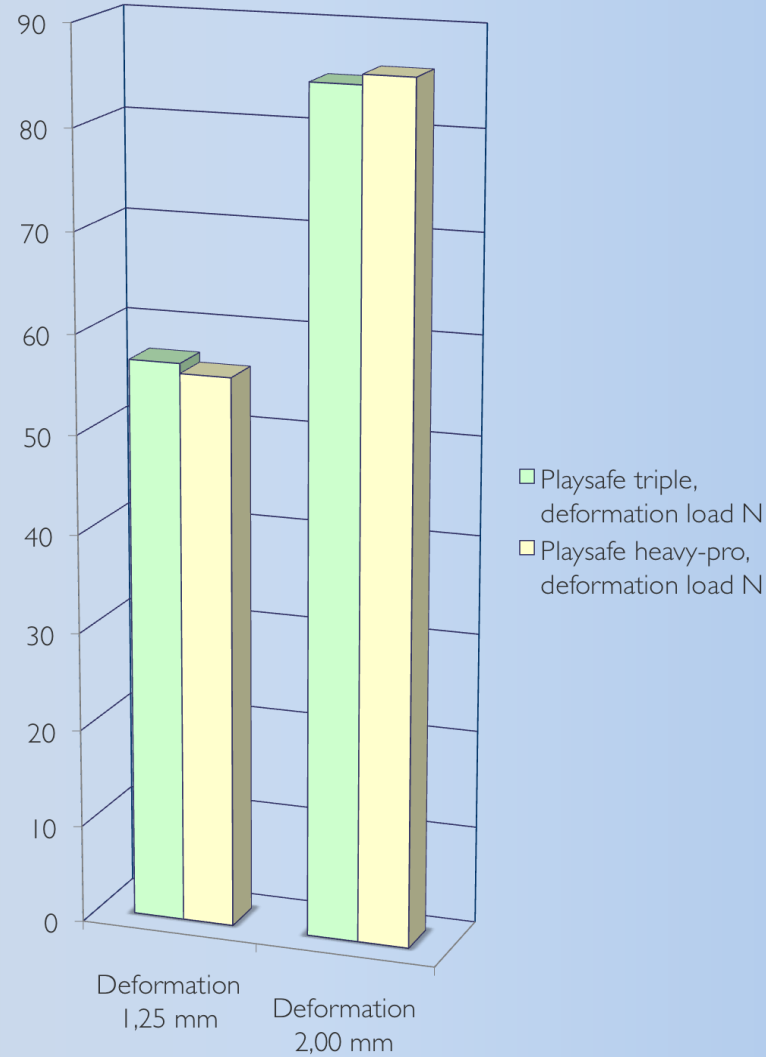
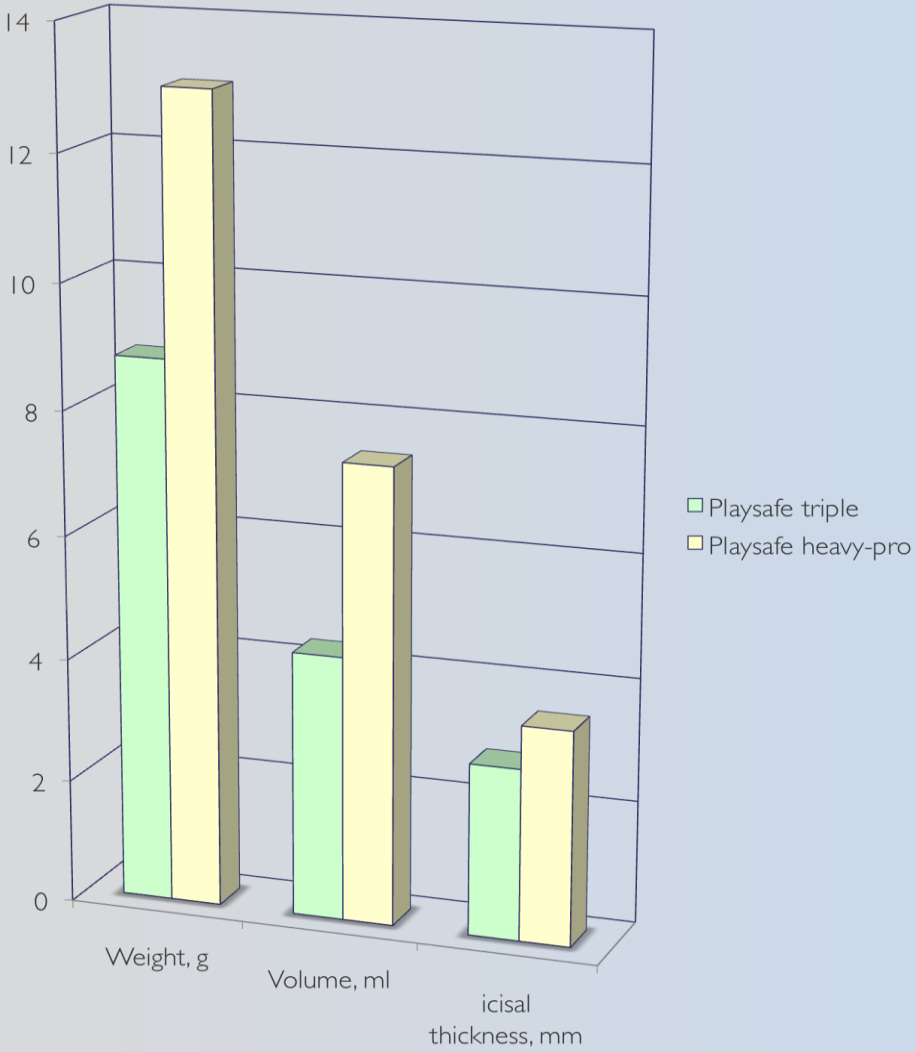

Playsafe  
sports-mouthguards

**PLAY SAFE**<sup>®</sup>

**PLAY SAFE**<sup>®</sup> triple

Thank you very much  
for your attention



# Playsafe sports-mouthguards...

...for kids?

- In principle sports mouthguards for children are made identical to those for adults. Depending on the sport, the same protection is required. Especially for children less protection is out of place.

- With regard to the model preparation, the expansion of the sports mouthguard and the wearing time, there are differences.

- Carrier of fixed orthodontic appliances are a special case.

- The possibility of re-adaptation of Playsafe sports-mouthguards is particularly important in children.



**PLAY SAFE**<sup>®</sup>

Laminated sports-mouthguards, two or three layers.



**PLAY SAFE**<sup>®</sup> triple

Prelaminated sports-mouthguards, three layers.



## Dental injuries

The dental injuries in children differ only slightly from those of adults.

Only intrusion injuries are more common.

- Crown fracture
- Root fracture
- Extrusion injury
- Intrusion injury
- Jaw fracture





## Particularities of models with mixed dentition

- Low retention
- Teeth in eruption
- Growing teeth
- Misaligned teeth
- Strong vestibular undercuts

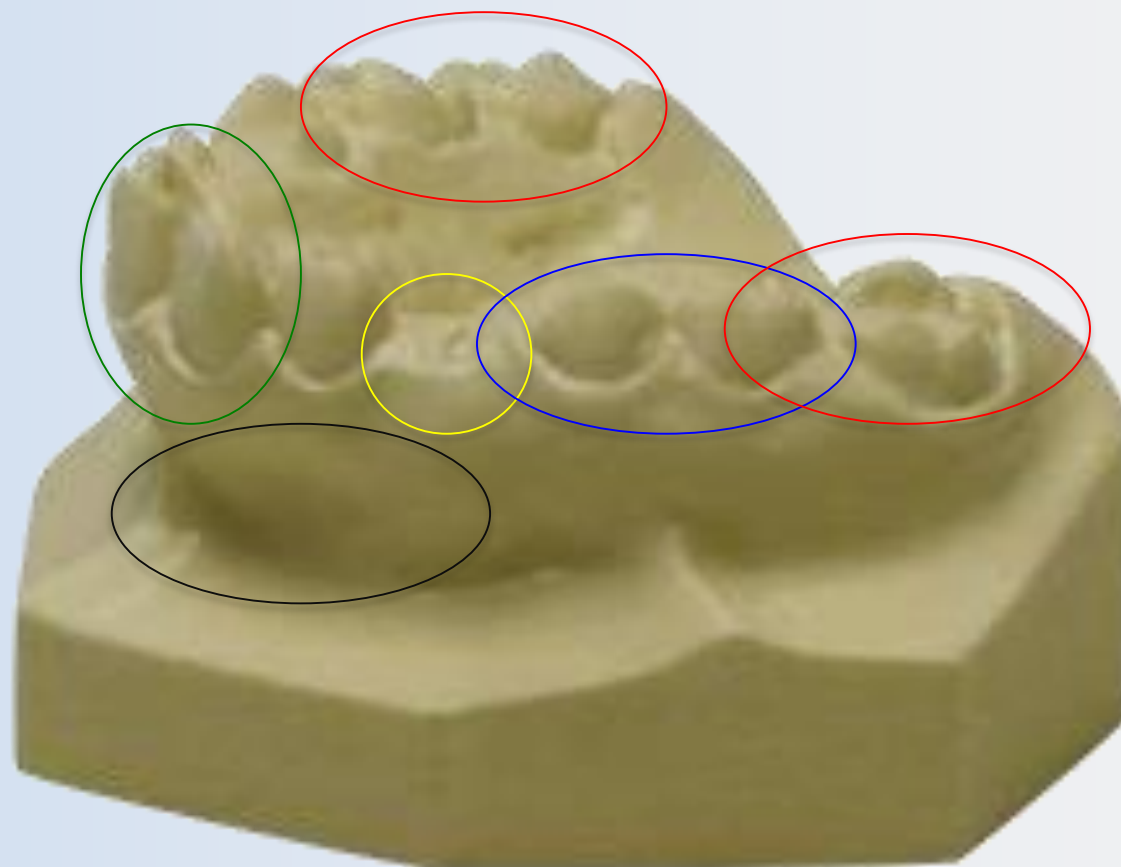

## Model preparation

- **Low retention**

Sufficient retention should nevertheless be achieved. For example, by taking advantage of the vestibule or of misaligned teeth.

- **Teeth in eruption**

Release by blocking out.

- **Growing teeth**

Give a little space by blocking out.

- **Misaligned teeth**

Use for retention, but block out strong undercuts.

- **Strong vestibular undercuts**

Use for retention. Adapt the sportsguard design according to the insertion direction.

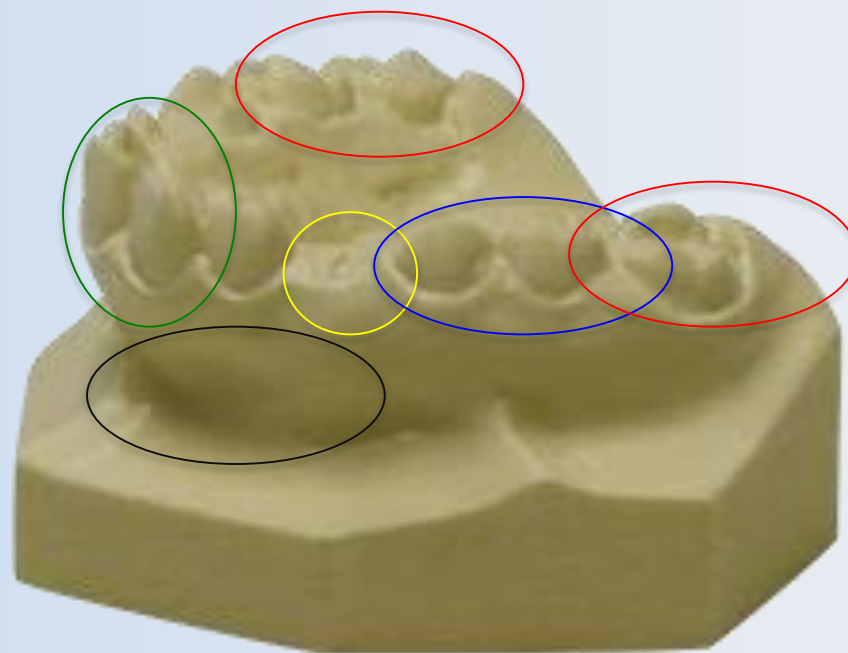

# Where to block out or to give space?

To obtain a good impression area (buccal shield) of the lower teeth, missing teeth or interdental gaps the lower jaw should also be blocked out.



Examples:

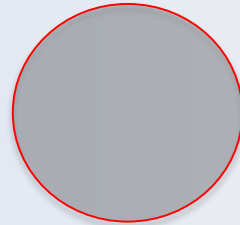

## Sports-mouthguard extension

The drawing shows the extension for adults.

Also for kids a Playsafe includes the first permanent molar, if present, but does not enclose the last tooth distally (molar or deciduous molar).

A Playsafe mouthguard covers the vestibular bone as far as possible (a).

It covers the teeth including the first molar (b).

The bite opening should be 4 – 5 mm for adults and 3 mm for kids at the incisal point (c).

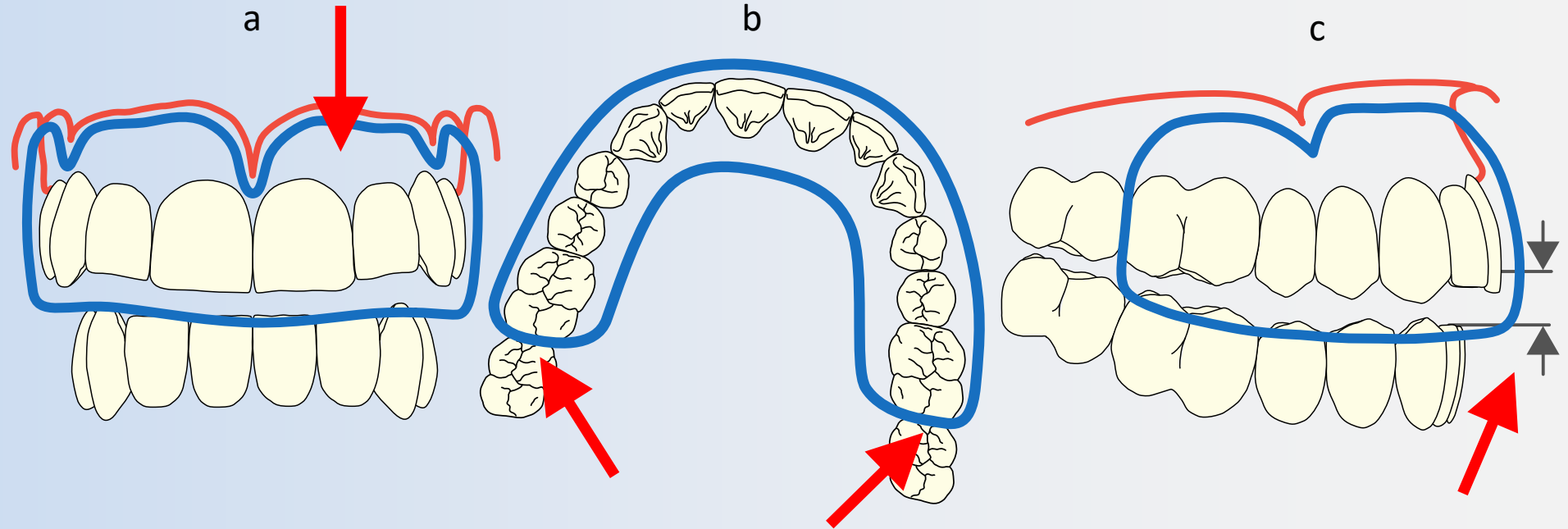

# Which Playsafe type for kids?

Dental injuries among children are caused by sports instruments and equipment, but much more often through collisions and falls.

For this reason and because intrusion injuries are common, the sports mouthguard should have a force distributing hard intermediate layer.

The **Playsafe light-pro** and the **Playsafe triple-light** have this layer.

The overall thickness of these types are already designed for kids.

Playsafe light-pro, 3 layers

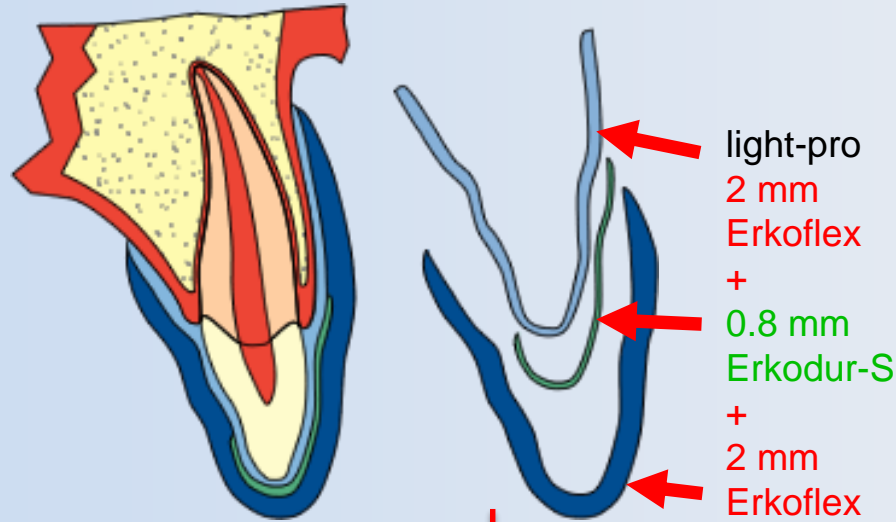

Playsafe triple-light, 3 prelaminated layers

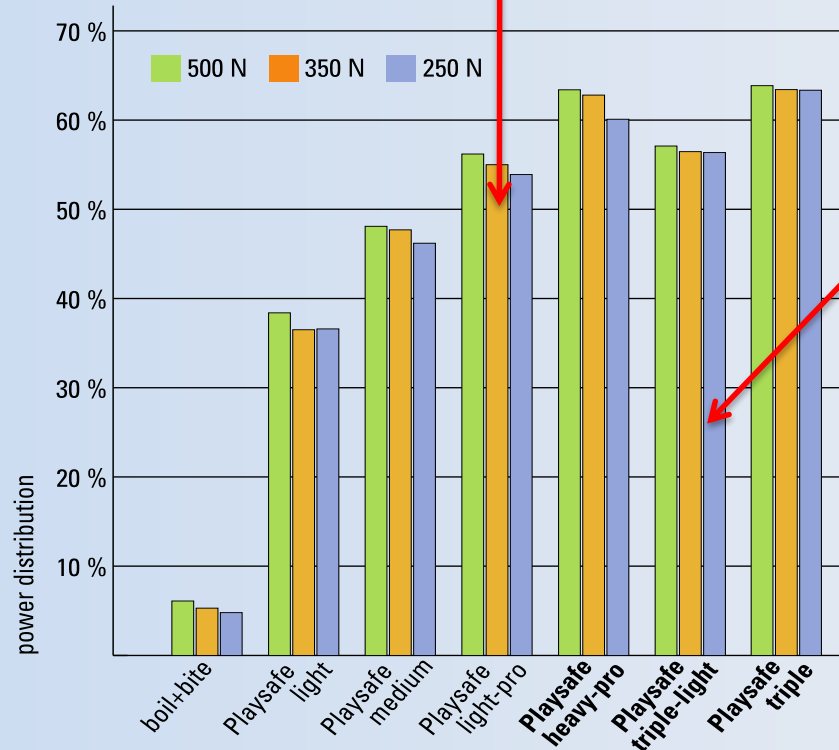
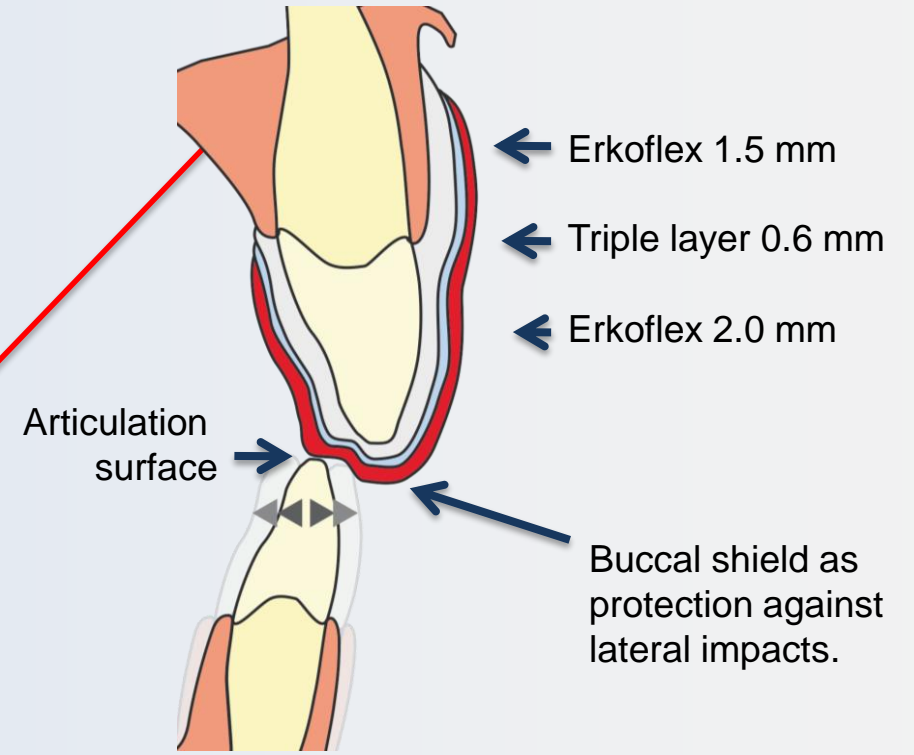

## Playsafe when wearing brackets?

Due to the rapid change of the bite, a Playsafe on brackets has only a short time of wear.

To avoid deformation of the orthodontic appliance the hard intermediate layer is highly recommended.

1. Impression taking without wiring or wax covered brackets and wire.
1. Block out well, brackets, wire and the zone root-towards the brackets with Erkogum. Otherwise removal and insertion are rather impossible.

A later re-adaptation is not possible.

Example:  
**Playsafe triple-light**

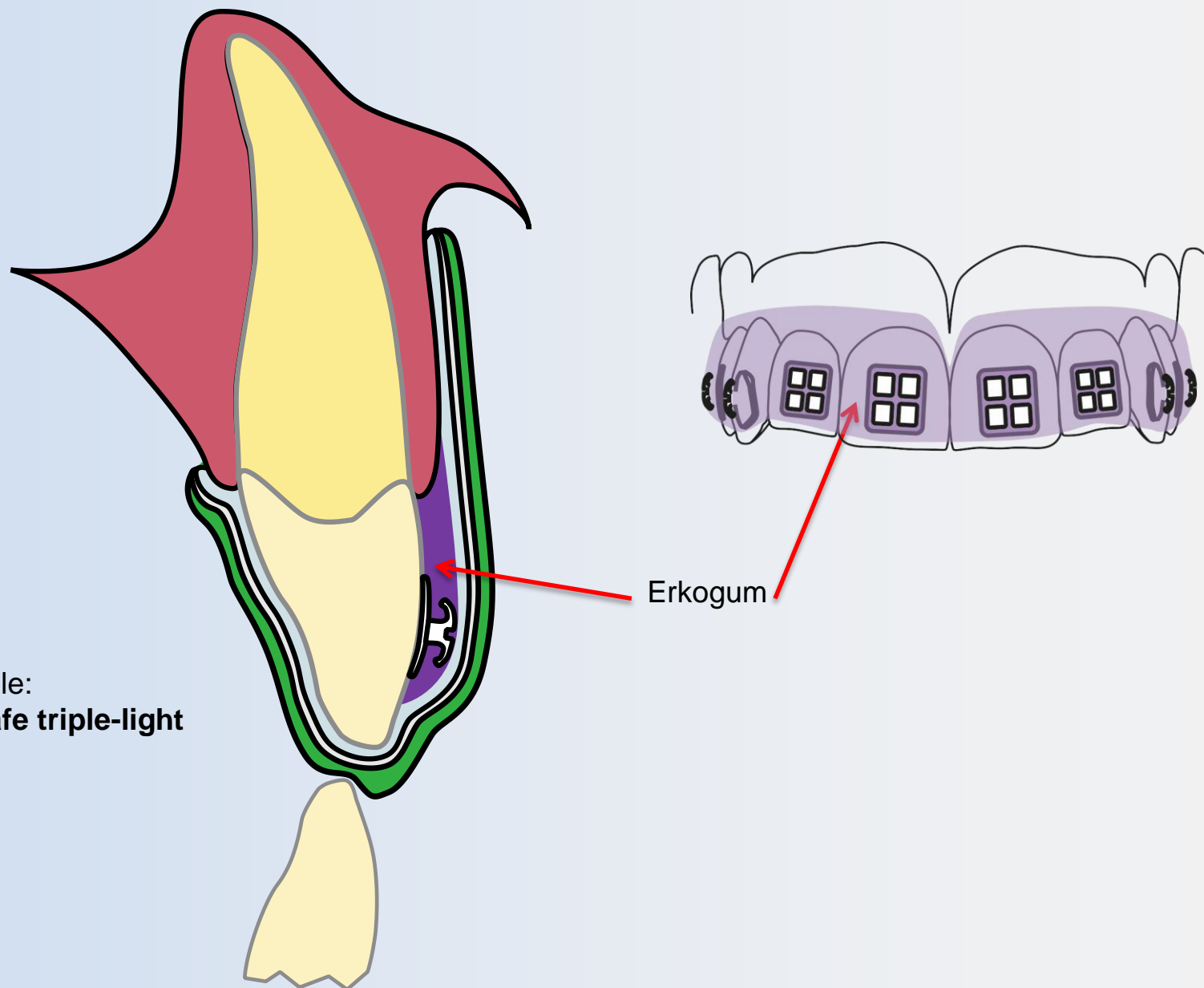

# Playsafe sports-mouthguards

## Playsafe re-adaptation

### Instructions

Laminated Playsafe mouthguards can be readapted to a changed dentition.

It is most important to pay attention that the owner of the mouthguard does not bite too hard into the softened mouthguard.

**PLAY SAFE**® + **PLAY SAFE**® triple



**1.** Put the mouthguard for 10 - 15 seconds into water at boiling temperature.



**2.** Take it out with the help of a spoon or similar.



**3.** Briefly (max. 2 sec.) drown the guard under cold water.



**4.** Now the surface is cold enough to take the guard in the hands and...

# Playsafe sports-mouthguards

## Playsafe readaptation

### Instructions

The risk of biting through the material must be minimized. A bitten through mouthguard loses its protection effect. (See step 6 + 7.)

Each readaptation will slightly thin the guard, therefore it is recommended to readapt the guard not more often than five times.

**PLAY SAFE**® + **PLAY SAFE**® triple



5. ...to place it into the owners mouth.



6. Push the guard upwards with little power.



7. **The owner should not bite into the guard uncontrolled. Better guide the patients lower jaw into the guard.**



8. The owner pushes with the tongue against the guard and the helper with the hand onto the cheeks in the gingival margin area. This position has to be kept for 2 min. (!), finished.



Good luck!

