

NANORAY

Portable X-ray

Model Name: NR-F300



USER MANUAL

DOC. No. UM-01(Rev.4)

CE
0068

Notice

The **NR-F300** is a portable dental X-ray system.

This manual contains descriptions, operational instructions, imaging procedures for the **NR-F300** dental X-ray system. It is recommended that you thoroughly familiarize yourself with this manual in order to make the most effective use of this equipment. Observe all cautions, safety messages and warnings that appear in this manual.

Keep this manual with the equipment at all times, and review the operation procedures and safety instructions if needed.

The illustrations/photos of the equipment in this manual are only for illustration purposes. Actual equipment may differ.

The safety and operating instructions should be retained for future reference.

All instructions should be followed.

This appliance should not be used near water

This appliance should be situated away from heat sources such as radiators, heat registers, stoves, or other appliances (including amplifiers) that produce heat.

This appliance should be connected to a power supply only of the type described in the operating instructions or as marked on the appliance. If you are not sure of the type of power supply to your home, consult your appliance dealer or local power company.

If the appliance is equipped with a polarized alternating-current line plug, this plug will fit into the power outlet only one way.

Due to continuous technological improvements, the manual may not contain the most updated information. For further information not covered in this manual, please contact us at:

NANORAY Co., Ltd

Phone: (+82) 53 962 4900

E-mail: service@nano-ray.com

This document is originally written in English.

The NR-F300 is referred to as Equipment in this manual.

Manual Name: The Ray (Model: NR-F300) User Manual Version: Rev.3

Publication Date: 2018-06-27

DO NOT OPERATE THIS DEVICE UNTIL YOU HAVE READ THIS MANUAL.

Table of Contents

Notice	2
Table of Contents	3
1. General and Regulatory Information	5
1.1 Manufacturer's Liability	5
1.2 Owner and Operator's Obligations.....	5
1.3 Conventions Used in this Manual	6
1.4 Marks and Symbols.....	7
1.5 Standards and Regulations	12
2. Safety Instructions.....	13
2.1 General Safety Guidelines	13
2.2 Warnings and Safety Instructions	14
2.3 Using Super Capacitor.....	16
2.4 Contraindication.....	17
3. System Overview	18
3.1 Indications for Use	18
3.2 Principles of Operation.....	18
3.3 Intended User Profile	18
3.4 Components	19
3.5 Features	19
3.6 General view of the equipment	19
4. Instructions for Use	22
4.1 The frequently used functions.....	22
4.2 Operating the wheel to change mode	22
4.3 Power On / Off.....	23
4.4 LCD (Liquid Crystal Display) panel	23
4.5 Checking the remaining in Super Capacitor	24
4.6 Charging the Super Capacitor	24
4.7 Interfaces between the software system and other systems	25
4.8 Main functional elements and functionality.....	25
4.9 Selecting the exposure mode	26
4.10 Positioning.....	27
4.11 Exposure times Auto-save mode / Reset exposure time.....	33
4.12 Power off mode	33
4.13 Troubleshooting.....	34
4.14 Charging the Battery.....	35
5. Maintenance	36
5.1 Storage.....	36
5.2 Cleaning	36
5.3 Maintenance.....	37
6. Disposing of the Unit	39
7. Product Specifications	40
7.1 Mechanical Specifications.....	40

7.2	Technical Specifications.....	42
7.3	Electrical Specifications	47
7.4	Environmental Specifications.....	47
8.	Appendix.....	48
8.1	Tables of Exposure Times (Default).....	48
8.2	X-ray Dose Data	50
8.3	Electromagnetic Compatibility (EMC) Information.....	55
8.4	Abbreviations.....	59

1. General and Regulatory Information

1.1 Manufacturer's Liability

The manufacturers and/or retailers of this equipment assume responsibility for the safe and normal operation of this product only when:

- Genuine NANORAY approved equipment and components have been used at all times.
- All maintenance and repairs have been performed by NANORAY authorized agent.
- The equipment has been used normally in accordance with the user's manual.
- The equipment damage or malfunction is not the result of an error on the part of the owner or operator.





1.2 Owner and Operator's Obligations

- The owner of this equipment shall perform constancy tests at regular intervals in order to ensure patient and operator safety. These tests must be performed in accordance with local X-ray safety regulations.
- The owner of this equipment shall perform regular inspection and maintenance of the mechanical and electrical components in this equipment to ensure safe and consistent operation (IEC 60601-1).
- The owner of this equipment shall ensure inspection and cleaning work is performed in accordance with the maintenance schedule outlined in **Chapter5 Maintenance**.

1.3 Conventions Used in this Manual









The following symbols are used throughout this manual. Make sure that you fully understand each symbol and follow the instructions which accompany it.





To prevent personal injury and/or damage to the equipment, please observe all warnings and safety information included in this document.

	WARNING	Indicates that a specific hazard is known to exist which through inappropriate conditions or actions may cause: <ul style="list-style-type: none">• Severe personal injury (to the operator and/or patient)• Substantial property damage.
	CAUTION	Indicates that a potential hazard may exist which through inappropriate conditions or actions will or can cause: <ul style="list-style-type: none">• Minor injury• Property damage.
	IMPORTANT	Indicates that a potential problem may exist which through inappropriate conditions or actions can cause: <ul style="list-style-type: none">• Property damage.
	NOTE	Indicates precautions or recommendations that should be used in the operation of the system, specifically: <ul style="list-style-type: none">• Using this Manual• Notes to emphasize or clarify a point.

1.4 Marks and Symbols

The following table describes the purpose and location of safety symbols and other important information provided on the equipment.

Mark/Symbol	Description	Location
	Alternate current	Battery Charger Label
	Direct current	Main Label
	Attention: consult accompanying documents	Main Label
	IEC60601-1 Degree of Protection from Electric Shock TYPE B Equipment	Main Label
	Radiation hazard	Main Label Generator Label
	Authorized European Representative address	Main Label
	The CE symbol indicates that this product complies with the European Directive for Medical Devices 93/42/EEC as amended by 2007/47/EC as a class IIb device.	Main Label
	High voltage hazard	Mono block

Mark/Symbol	Description
	<p>Manufacturer's name and address</p>
	<p>Date of manufacture</p>
	<p>This symbol indicates that electrical and electronic equipment must not be disposed of as unsorted municipal waste and must be collected separately.</p>
	<p>ESD susceptibility symbols indicate that an item is susceptible to damage from electrostatic discharges.</p>
	<p>Refer to the User Manual.</p>

1.4.1 Label
Device Label

NANORAY

CAUTION
X-RAY/ATTENTION : X-RAY ON WHEN EQUIPMENT IN OPERATION

Product : Portable X-ray
Model : NR-F300
Power Input : 10.8 V 
Output : Max. 70 kV / 3.0 mA(60 kV / 3.0 mA)
X-ray Tube Model : KL11-0.4-70
X-ray Tube Serial Number : 1720427
Inherent Filtration : 0.8 mm Al Eq.
Total Filtration : 1.5 mm AL Eq.
Focal Spot : 0.4 mm
X-ray Generator Model : NRF-100-G1
X-ray Generator Serial Number : NRG1-OGTA611

SN NRF300-1704-0148

NANORAY Co., Ltd.
401, 402, 403, 408, 409, 76,
Dongnae-ro, Dong-gu,  2018-01
Daegu, Korea

EC REP CALMED INVEST Kft.(HU11678179)
Attila utca 34., Budapest, 1191, Hungary

 0068

Size: 45W * 55L

Cradle

NANORAY

Product : CRADLE
Purpose of use : User's Manual Reference
Packing unit : 1 PCS
Adaptor manufacturer : POWER-TEK
Adaptor model : SW60-12005000-W
Adaptor Input : (100-240) V~, (50/60) Hz, 1.5 A
Adaptor Output : 12 V  , 5.0 A

 NANORAY Co., Ltd.
401, 402, 403, 408, 409, 76, Dongnae-ro,
Dong-gu, Daegu, Korea

 2018-01 **SN** CRD - 1801-0001

Size: 45 W * 30 L

Adaptor



Size: 39.8 W * 80.2 L

Rectangular cover

Rectangular Cover (4x3)



Rectangular Cover (2x3)



1.4.2 Positioning of Label

Device Label

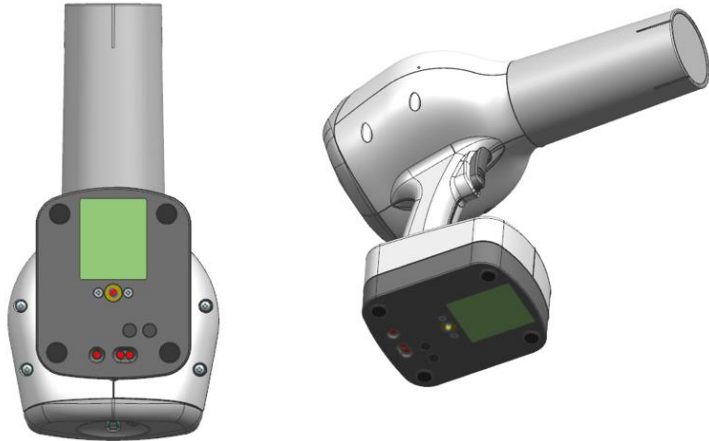

Cradle

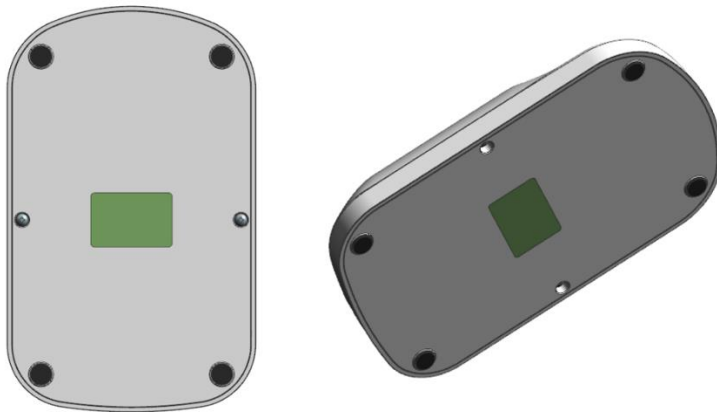

The labels in this manual are only for illustration purposes. Actual labels may differ.

1.5 Standards and Regulations

Standards:

The NR-F300 is designed and manufactured to meet the following standards:

- IEC/EN 60601-1, IEC/EN 60601-1-2, IEC/EN 60601-1-3, IEC/EN 60601-2-65
- IEC 60601-2-65:2012 Particular requirements for the basic safety and essential performance of dental intra-oral X-ray equipment
- ISO 13485

Classifications (IEC60601-1 6.1):

Protection against the ingress of water: Ordinary Equipment (IPX0)

Protection against electric shock: Class I equipment, Type B Applied Parts: Cone head



2. Safety Instructions

2.1 General Safety Guidelines

1) General Safety Guidelines

- This product requires a longer break time than the exposure time after an X-ray exposure. The minimum duty cycle rating (the relationship between duration and frequency of exposures) is 1:30.

Duration	0.08s	0.32s	0.56s	1s
Cycle	Every 3s	Every 10s	Every 17s	Every 30s

- This product is designed and manufactured in order to ensure the maximum safety. Operation and Maintenance must be in accordance with the instructions contained in this manual.
- This product must only be operated by legally qualified.(Dentist or Dental hygienist)
- Observe all the local fire regulations keep a fire extinguisher near the product at all times.
- Maintenance and services for the product should be taken by qualified service personnel according to procedures and preventive maintenance schedules.
- Always turn off the product before cleaning.
- The device uses beam limiting device(rectangular cover) for protection against stray radiation

2) Expected Service Life: **2 years**

- PRODUCT SPECIFICATION: Connect Cable (Battery is replaceable and does not affect life cycle)
- Bending times: Max 10,000 times
- 10 times bend/hour
- Max 1-day use time: 10hours, 4times use per month=40 hours per month,
- 40 hours = 400 times bend, $10000/400=25$ months
- Expected service life: 25 months / 12 months = 2.08 years
- Final ESL: 2 years

2.2 Warnings and Safety Instructions



This X-ray unit may be dangerous to patient and operator unless safe exposure factors, operating instructions and maintenance schedules are observed.

It is important to read this user manual carefully and strictly abide by all warnings and cautions stated within it.



To avoid risk of electric shock, this equipment must only be connected to a supply main with protective earth.



Since rules and regulations concerning radiation safety differ between countries, it is the responsibility of the owner and/or operator of this equipment to comply with all applicable rules and regulations concerning radiation safety and protection in their area.



Avoid touching the patient with equipment during X-ray exposure

- Exposing the product to water or moisture may cause an electrical shock or damage the product. Keep it away from water and moisture.
- Do not place any flammable materials near the product.
- Do not open or remove the cover of the product.
- For electronic medical devices, special attentions regarding electromagnetic waves are required.
- Modifying the product may damage it beyond repair and damage users and patients, thus modifying and remodeling the product (including cables) is prohibited.
- Patients should be provided lead aprons for radiation protection
- Patients (children and pregnant women particularly) must wear lead aprons during their X-ray imaging.
- Children and pregnant women must consult with their doctors before X-ray examinations.
- When users or responsible agencies take particular examinations or treatments, there might be serious hazard (e.g. noises) from the product itself.
- As the charger must be located and used at place, where users can easily connect and disconnect it to the power supply. Keep the charger in place to use at the easily accessible place.

- Users and patients are advised to use the hand-held x-ray equipment in accordance with the method of use guided by Ionizing Radiations Regulations 1999(IRR99).

Especially for pregnant women, it is recommended to use personal dosimetry and a lead apron

Radiation Safety



When using the equipment, it is recommended that all users comply with the following radiation safety guidance for the safety of the users and the patients.

- This equipment should be operated by a trained and qualified Dentist or a Dental hygienist in a controlled environment.
- All users and patients should wear protective equipment, such as a lead apron, thyroid collar, etc.
- This equipment should be operated in the area that is more than 6 feet away from other personnel, such as assistants or other patients. If they should stay closer than 6 feet, it is recommended that they wear a lead apron, thyroid collar, or stay behind a lead shield.
- Pregnant women should not be exposed to X-rays unless it is strictly necessary.
- All users should comply with the Radiation Protection Policies established by the government.

2.3 Using Super Capacitor

- Make sure to charge the super capacitor in the external environment from the patient.
- Make sure to use the super capacitor only provided or approved by NANORAY. If non- standard or damaged super capacitors are used, there is risk of fire and explosion.
- Make sure to use the cradle only provided or approved by NANORAY. Using an unauthorized cradle may result in super capacitor damage.
- DO NOT expose super capacitor to heat or fire. Avoid storage in direct sunlight.
- DO NOT short-circuit, crush, puncture, mutilate, or disassemble the super capacitor.
- DO NOT store super capacitor haphazardly in a box or drawer where they may short- circuit each other or be short-circuited by other metal objects.
- DO NOT remove the super capacitor from its original packaging until required for use.
- DO NOT subject super capacitor to mechanical shock.
- In the event of a cell leaking, do not allow the liquid to come in contact with the skin or eyes. If contact has been made, wash the affected area with copious amounts of water and seek medical advice.
- DO NOT make the super capacitor wet or let it be in water. Keep super capacitor clean and dry.
- Keep the super capacitor away from children and pets.
- Seek medical advice immediately if the super capacitor has been swallowed.
- DO NOT dispose of super capacitor with ordinary trash. Turn in discharged super capacitor to local supply or discard or recycle super capacitor according to your local government regulations.
- The super capacitor cannot be replaced by users.
- When charging the super capacitor, the exposure function is locked.
- DO NOT leave a super capacitor on prolonged charge when not in use.
- If the equipment has not been used for long periods of time, it is recommended to charge the super capacitor before use.
- After extended periods of storage, it may be necessary to charge and discharge the cells or super capacitor several times to obtain maximum performance.
- Be sure to turn off the equipment when not in use. This helps to ensure the life

of the super capacitor.

- If the equipment not in use has been turned on for long periods of time, the super capacitor may be fully discharged.

24 **Contraindication**

- patients (children and pregnant women particularly) must wear lead aprons during their X-ray imaging.

3. System Overview

The NR-F300 is a portable dental X-ray for producing intra-oral image and operates on 10.8V DC supplied by a supercapacitor.

The NR-F300 is composed of high voltage module including x-ray tubes and electric circuits, main control unit, user interface and x-ray iris (collimator).

NR-F300 can be used with an intra-oral imaging sensor.

The NR-F300 is used for dental diagnosis in adult and pediatric patients and is available only to trained and qualified dentist or dental technician.

3.1 Indications for Use

The NR-F300 is a portable dental X-ray system intended for use by a trained and qualified dentist or dental technician to produce diagnostic dental X-ray images for dental treatment of both adult and pediatric subjects.

3.2 Principles of Operation

NR-F300 is an X-ray device capable of diagnosing anatomical oral structures. The free electrons generated from the cathode in the X-ray tube are caused to generate a high voltage between the cathode and the anode in the X-ray tube by using a high-voltage generator, and the generated X-rays are irradiated to the teeth of the human body

3.3 Intended User Profile

Considerations	Requirement Description
Education	Licensed dentist or dental hygiene, radiologist and graduates of relevant bachelor's degree (national qualifications)
Knowledge	The operator must have understood: <ul style="list-style-type: none">• treatment and diagnosis of dental disease• terms and guidance of diagnostic medical radiation devices• device connection, installation and operating conditions.
Language understanding	The operator must have understood: <ul style="list-style-type: none">• the English or Korean manuals (or other languages provided).
Experience	The operator must have understood: <ul style="list-style-type: none">• objectives and effects of treatment and diagnosis of dental disease using diagnostic medical radiation devices• normal operation of diagnostic medical radiation devices• the contents of the user manual.

3.4 Components

No.	Item	Standard	Option	Qty.
1	NR-F300 Main Body	•		1
2	User Manual	•		1
3	Cradle (power cord included)	•		1
4	Rectangular Cover (2x3)		•	1
5	Rectangular Cover (4x3)		•	1

3.5 Features

The NR-F300 is an intra-oral portable X-ray that offers safety, reliability, and greater functionality:



- Lightweight and ergonomic design
- Convenience of cordless design by using Super Capacitor
- Micro-computer and specialized circuit that monitors and precisely regulates the exposure technique factors (kV, mA, and exposure time)
- Pre-programmed exposure time makes the operation fast and easy.

3.6 General view of the equipment

3.6.1 Components

- The product consists of the components below.

No.	Figure	Name	Specifications
1		Main Body DC 12V 5A	70 kV /3.0mA, 60KV/3.0mA

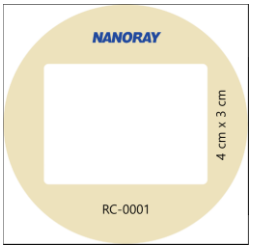
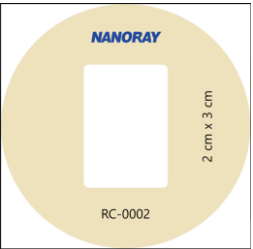
2		AC220V to DC 12V Adaptor & 220V Power Cable	Input Voltage : AC 100V ~ 240V, 50Hz ~ 60Hz 1.5A Output Voltage : 12V Output Current : 5A Maximum Power : 60W Approved by IEC 60950-1
3		Charging cradle	Input Voltage : 12 V Output Voltage : 10.8V
4		Rectangular Cover (RC-0001)	4cm x 3cm
5		Rectangular Cover (RC-0002)	2cm x 3cm



3.6.2 Name of each parts



No.	Item	Description
1	LCD	Indicates status of the product
2	Mode-changing wheel	Changes the X-ray exposure mode, and turns the product on/off
3	X-ray collimator (Cone)	Limits X-ray exposure area
4	Exposure button	Used for X-ray exposure
5	Handle	Used to hold the product
6	Cradle	Used to charge for battery
7	Adapter connection hole	Hole for adapter connection

4. Instructions for Use

4.1 The frequently used functions

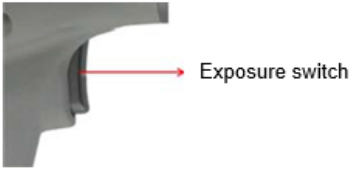
<p>Press the wheel button to turn on/off the system.</p>	<p>Click the wheel at least one second to turn on. Click the wheel at least four seconds to turn off</p> 
<p>Scroll the wheel button to select the mode.</p>	<p>scroll the wheel for moving the mode. Press the wheel for selecting the mode.</p> 
<p>Press the exposure switch to exposure</p>	<p>Press the exposure switch for X-ray irradiation.</p> 

4.2 Operating the wheel to change mode

- Click: Pressing the mode-changing wheel is called "Click."
- Scroll: Rolling the mode-changing wheel up and down is called "Scroll."





4.3 Power On / Off

- Click the wheel for at least one second to turn on.
- Click the wheel for at least four seconds to turn off

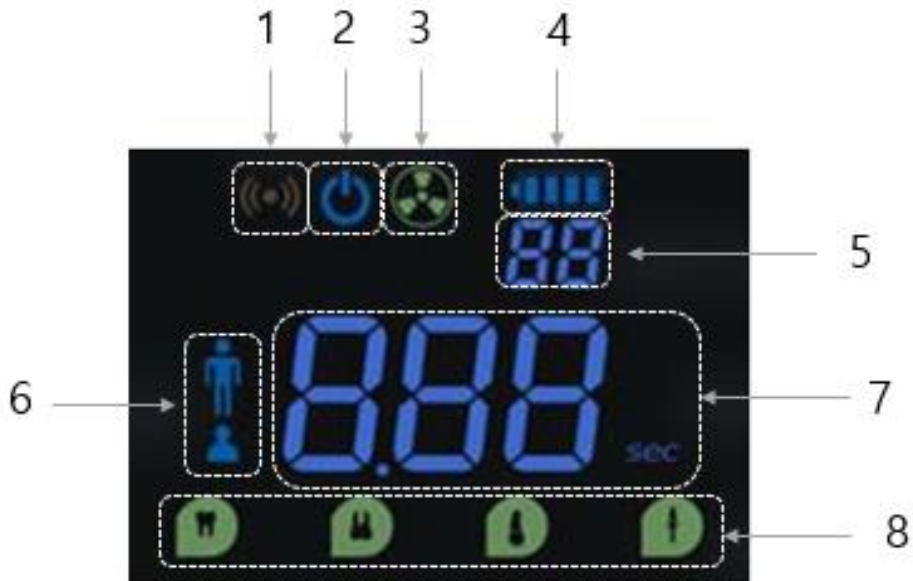
4.4 LCD (Liquid Crystal Display) panel







No.	ICON	Description
1		Requires the user to pay attention such as charging or waiting.
2		Being charged.
3		X-ray is being exposed.
4		Super capacitor indicator.
5		Waiting time for retaking an X-ray
6		Adult or child

7		Exposure time and charging status Chr being charged rdy fully charged
8		Selected teeth Bitewing → Mandible molar → Maxillary molar → Canine → Incisor in sequence

4.5 Checking the remaining in Super Capacitor

-Make sure that at least one battery indicator light comes on.

	0-25% remaining
	25-50% remaining
	50-75% remaining
	75-100% remaining

4.6 Charging the Super Capacitor

Lob	needs to be charged
Chr	being charged
rdy	fully charged.

4.7 Interfaces between the software system and other systems

User Interface	Function	Interface specification
Wheel	<ul style="list-style-type: none"> - Program start, end - tooth selection - Select the exposure object - Select the type of exposure - Select the exposure time - Initialize exposure time - Administrator mode entry and exit (with Switch) - Change administrator mode - Change administrator mode setting value 	1 Wheel
Switch	<ul style="list-style-type: none"> - exposure - Administrator mode entry and exit 	1 Switch
LCD Monitor	<ul style="list-style-type: none"> - Display the start status of the system - Display the current status of the system (charge, exposure, battery level, exposure object selection mode, exposure time and Charge state, tooth selection) 	3.5 inch (Out size dimension 64mm * 46mm) (Viewing Area Dimension: 60mm * 41mm)
Cradle	<ul style="list-style-type: none"> - charge - Charging status LED indication 	1 Cradle
Buzzer	<ul style="list-style-type: none"> - Alarm sound output 	1 Buzzer

4.8 Main functional elements and functionality

No.	Contents	Function
1	System On/Off function	<ol style="list-style-type: none"> 1) Display the start status of the system 2) Display the shutdown status of the system
2	Information of System status and Progress message	Display of the current status of the system (charging, exposure, battery level, exposure object selection, exposure time and charge status, tooth selection, etc.)
3	Tooth selection mode	<ol style="list-style-type: none"> 1) Incisor mode 2) Canine mode 3) Maxillary molar 4) Mandible molar 5) Bitewing mode
4	Exposure object selection mode	<ol style="list-style-type: none"> 1) Adult mode 2) Child mode
5	Exposure selection mode	<ol style="list-style-type: none"> 1) DR mode 2) CR mode 3) Film mode

No.	Contents	Function
6	Exposure time mode	Display exposure time (0.01 – 1.00 sec) Selecting the Exposure time within the settable range of each mode
7	Exposure time limit mode	Limit setting range of each exposure time(Adult :DR, CR, Film mode, Child: DR, CR, Film mode)
8	Exposure time initialization	Initialization by operating exposure switch
9	Exposure	Display x-ray exposure status
10	Exposure limit	When performing other functions, it should not be exposed even though the exposure switch is pressed.
11	Charging mode	1)Display charging status 2) Display charging completion status 3) indicate charging status on cradle
12	Display battery charge	Display battery level step by step
13	Save setting value	When the power is turned off, the last setting value is saved. When the power is turned on again, it is automatically loaded, set and displayed
14	administrator mode	1) du mode 2) HF mode 3)Pr mode 4)PA mode
15	Alarm	1) System start (long sound) 2) System status change(single sound) 3) Exposure: double sound(single and long)

4.9 Selecting the exposure mode

- Select the type of teeth: click the wheel, and the mode will be changed into Incisor – Canine teeth – Mandible molar - Maxillary molar– Bitewing – (select adult or child).
- Select the mode for an adult OR a child: If you click the wheel once more in the “bitewing” mode, the current mode will be flickering. At this time, scroll the wheel up and down to change the mode you want; and select it by clicking the wheel.
- To begin the exposure, press the handle trigger. Simultaneously, TheRay emits a long beep. Followed by a short beep will be emitted after second press on handle trigger.



4.10 Positioning

To obtain high-quality intra-oral radiography with maximum details, take extra care in all steps of the radiography process: positioning the patient and the X-ray imaging system; exposing the intra-oral sensor.

- The table below show recommended specification of intra-oral sensor.

Specifications	CR	DR
Resolution	9 ~ 21 lp/mm	10 ~ 30 lp/mm
Pixel size	30~70 μm	10~50 μm

- The table below show recommended detectors.

Manufacture	CR/DR	Model
Carestream	CR	CS7200, CS7600
3DISC	CR	FireCR Dental Reader
Vatech	DR	EzSensor Soft

- The table below shows recommended angles of inclination (bisecting angle radiography) exposure times.

Tooth	Angle for inclination		Exposure Time Adult / Child
	Upper	Lower	
Incisor	45°	-25°	0.13 / 0.1
Canine	45°	-20°	0.2 / 0.16
Molar	30°	-5°	0.24~0.26 / 0.19~0.22
Bitewing	5~8°		0.29 0.24

- Paralleling radiography: A technique to radiograph by maintaining the x-ray collimator (CONE) in parallel with the axis of the teeth using the support.

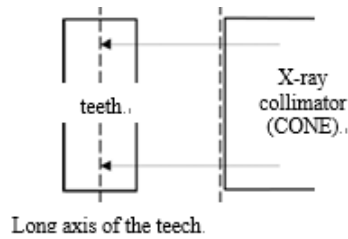

- Bisecting radiography: A technique to radiograph while the examinee (patient) holds the intraoral sensor (or film) in place with his/her finger. The X-ray beam is directed perpendicularly towards an imaginary line, which bisects the angle between plane and the long axis of the teeth.

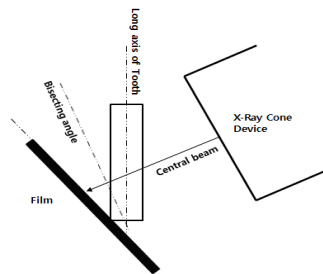

Here are the specific angulations and directions for the tube head in order to take the best images of a particular tooth (i.e. **Bisected angle technique**).



Position the receptor carefully not to damage the soft tissue of the patient's intra-oral area.



When using the device, the device should never touch the patient

- **Maxillary Incisor**

X-ray beam is directed downward at 45°.



Tooth		Angle of inclination
Incisor	Maxilla	+45°

- **Mandibular Incisor**

X-ray beam is directed downward at 25°.



Tooth		Angle of inclination
Incisor	Mandible	-25°

- **Maxillary Canine**

X-ray beam is directed downward at 45°.



Tooth		Angle of inclination
Canine	Maxilla	+45°

- **Mandibular Canine**

X-ray beam is directed downward at 25°.



Tooth		Angle of inclination
Canine	Mandible	-25°

- **Maxillary Molar and premolar**

X-ray beam is directed downward at 30°.



Tooth		Angle of inclination
Molar and premolar	Maxilla	+30°

- **Mandibular Molar and premolar**

X-ray beam is directed downward at 5°.



Tooth		Angle of inclination
Molar and premolar	Mandible	-5°

- **Bitewing**

For a bitewing exposure, the patient doses their tooth during exposure on the sensor holder.

X-ray beam is directed downward at $5^{\circ} \sim 8^{\circ}$.



Tooth	Angle of inclination
Bitewing exposure	$+5^{\circ} \sim +8^{\circ}$

4.11 Exposure times Auto-save mode / Reset exposure time

- When initially used, exposure times will operate at the default value when power is cycled.
- When automatically saving exposure time
 - (1) When you press a wheel to blink an adult or a child, turn the wheel up so that the mode indicator is " - ". After that press the exposure switch for 5 seconds.

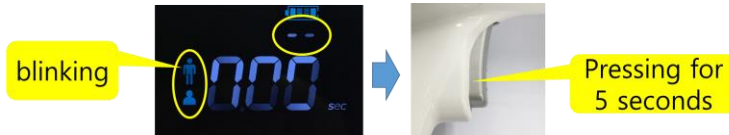

- (2) When the product is turned off, press the wheel to turn it on before using it.

- If you want to cancel automatically saving exposure time settings
 - (1) When you press a wheel to blink an adult or a child, turn the wheel up so that the mode indicator is " S - ". After that press the exposure switch for 5 seconds.

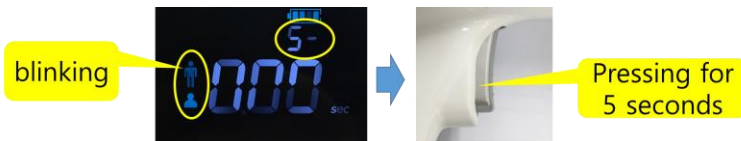

- (2) When the product is turned off, press the wheel to turn it on before using it.

- When initialization of saved exposure time
 - (1) When you press a wheels to blink an adult or a child, press the exposure switch for five seconds.
 - (2) When the product is turned off, press the wheel to turn it on, and it will be displayed as the default value.

4.12 Power off mode

- Click the wheel for at least four seconds to turn off



4.13 Troubleshooting

Error Code	Potential Problem	Corrective Action
E01 (Filament current over)	It occurred overload on driving part of the tube filament	Check the MCU, check and replace the HVM
E02 (Filament current under)	It occurred no load on driving part of the tube filament	Check the MCU, check and replace the HVM It occurred malfunction or disconnected on driving part of the tube filament.
E03 (High voltage Feedback over)	It occurred overload on high voltage driving part of the tube filament	Check the MCU, check and replace the HVM
E04 (High voltage Feedback under)	It occurred no load on high voltage driving part of the tube filament	Check the MCU, check and replace the HVM
E05 (Low battery)	Remained voltage in the super Capacitor is less than the least voltage for screening	Recharge the super capacitor
E06 (Tube over temp)	The Generator temperature exceeds an error limit	Wait for cooling time (required more than 1 hour as duty cycle)
E07 (System Main Power error)	The problem comes from main board	Check the part of power on main board, Super Capacitor and the part of recharge on electrical circuit.
E08 (DCDC 12V load current over)	It occurred a short circuit on the part of 12V power.	Short circuit load
E09 (remain_bat)	Remained voltage in the super capacitor is less than working voltage after set up	Recharge the super capacitor or decrease the exposure time setting.
E10 (DC 12V over current)	overload on the power	Check the MCU
E11 (DC 12V no load)	It occurred overload on the power	Check the MCU

4.14 Charging the Battery

1. Connect the charging cable to Cradle
2. Plug the cradle into an electrical socket via the power supply unit provided.
 - if using it overseas please ensure that an appropriate adaptor for the country of visit is purchased prior to departure.
3. LED indicator lights on and turns red when provide an electricity.
4. Docking the equipment on the cradle properly.
5. The Super Capacitor is charged when the LED turns blue.



Do not turn on the equipment during charging.



1. Do not use the charger in humid conditions.
2. Do not use the charger if it has a damaged plug.
3. Do not use the charger after it has been dropped or damaged
4. Do not open / disassemble the charger.
5. Do not use the charger in direct sunlight
6. Do not charge in the environment with patient.

5. Maintenance

5.1 Storage



Avoid placing the product, the charger and the charging cradle in places, unlikely to have any issues/damages due to temperature/humidity, direct sunlight, dust and salinity.



Keep the charger and the charging cradle disconnected from the power supply when the product is not used for a long period of time
Avoid keeping the product near chemical or gas storage facilities

5.2 Cleaning



When cleaning the product, turn off the power and disconnect the charging cradle and the charger from the power.



When cleaning the surfaces make sure that the equipment is not connected to the cradle
The product surface can be wiped off with a soft cloth damped in noncorrosive alcohols or disinfectant.
If necessary, wipe off surfaces with disinfectant.



Do NOT allow liquids to drop into the product, the charger and the charging cradle.
Do NOT use spray cleaner or disinfectant, as this could cause a fire or



The soft cloth should be damp, but not dripping wet.
The cloths or wipes cannot be re-used.

5.3 Maintenance

NANORAY requires periodic constancy tests to ensure image quality and the safety for the patient and operator.

Only **NANORAY** authorized technicians can perform inspection and service of this equipment. For the technical assistance, contact **NANORAY** service center or your local **NANORAY** representative.

Note: If the product has a failure or malfunction that requires repair, it must be repaired by the manufacturer

Cautions and Notes



DO NOT keep the equipment or its parts in a humid place or near a liquid substance.



Avoid placing the equipment near chemical storage and gas-filled storage facilities.

5.3.1 Maintenance Task Checklist



Always turn off the equipment before performing any maintenance.

Tasks	Period
Before operation, ensure that the equipment is clean and ready for use.	Daily
After using the equipment, make sure that the equipment has been turned off.	Daily
Wipe the outer covers of the equipment with a dry cloth at the end of each day's operation.  DO NOT use detergents or solvents to clean the outer covers of the equipment.	Daily

Tasks	Period
Ensure that the signal is audible and the X-ray emission light is visible when you make an exposure.	Daily
Ensure that the yellow (exposure) indicator light turns on when the Exposure Button is pressed.	Daily
Ensure that the battery charging LED indicator comes on when charging the battery.	Daily
Ensure that all visible labels are intact and legible.	Monthly



CAUTION

If any defects are found, do not operate the equipment since it has to be handled by a qualified person. Contact your Service Representative.

6. Disposing of the Unit

In order to reduce environmental contamination, this equipment is designed to be as safe as possible to use and dispose of. Many components of this equipment are environment-friendly and can be recycled.

All parts and components that contain hazardous materials must be disposed of in accordance with disposal regulations. (IEC 60601-1 6.8.2 j)

Part	Material	Recyclable	Waste Disposal Site	Hazardous waste; Needs Separate Collection
Covers	Plastics	•		
Boards		•		
Cables and transformer	Copper	•		
Packing	Polystyrene	•		
	Cardboard	•		
	Paper	•		
X-ray tube				•
Battery (super capacitor)				•
Other parts			•	



Observe all regulations relevant to the disposal of waste in your country.



This symbol on the product and/or accompanying documents means that used electrical and electronic equipment (WEEE) should not be mixed with general household waste.

For professional users in the European Union:

If you wish to discard electrical and electronic equipment (EEE), please contact your dealer or supplier for further information.

For disposal in countries outside of the European Union:

This symbol is only valid in the European Union (EU). If you wish to discard this product, please contact your local authorities or dealer and ask for the correct disposal method.

7. Product Specifications

7.1 Mechanical Specifications

Dimensions

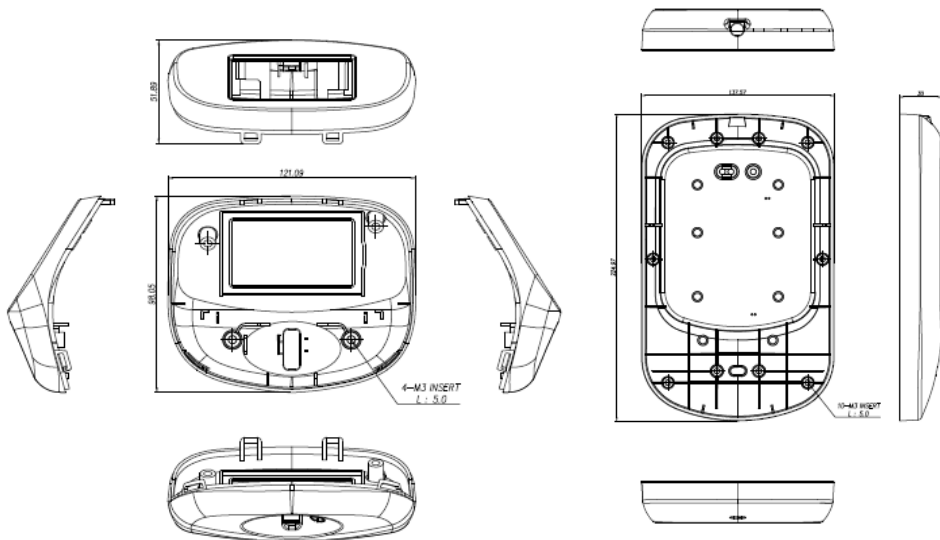
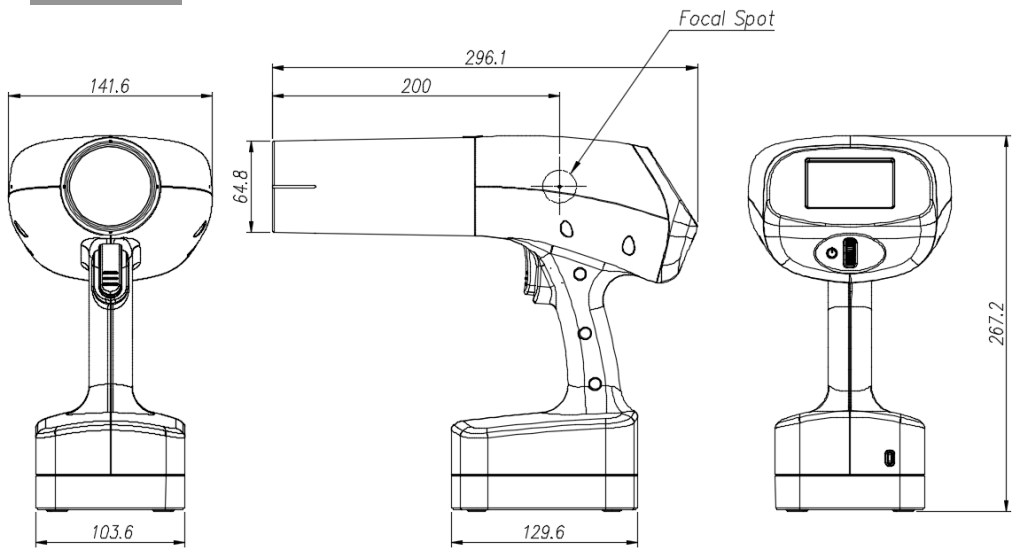

Item		Description	
Main Body	Dimension (mm)	296.1(L) x 267.2(H) x 141.6(W)	
	Weight (kg)	1.6 (± 10 %)	
X-ray Beam Limiting Device	X-ray Beam Area (mm)	Round Type	FOV: < ø 60
		Rectangular Type	FOV: 20 x 30, 40 x 30
	SSD(Source to Skin Distance) (mm)	200	

7.2 Technical Specifications

7.2.1 Portable dental X-ray

Items		Specifications
Model Name		NR-F300
Rated Input power	Device	DC 12V 5A
	Adaptor	100-240 VAC, 50-60Hz 1.5A
Rated output power		210W
Internal Power		10.8 VDC (Super capacitor), 8EA
kV/mA		70 kV /3.0 mA, 60KV/3.0mA
Exposure time range [sec]		0.01 - 1.00 sec \pm 5%
Measuring efficiency,	kV	\pm 10%
	sec	\pm 5%
	mA	\pm 20
Display		LCD Panel Display (3.5 Inch, BTN LCD, 1/4Duty, 1/3BIAS)
X-ray Tube	Model	KL11 -0.4-70 (Kailong)
	Inherent Filtration	Min. 0.8mm AL Eq @ 75kV
	Focal spot size	0.4 mm
Total Filtration	Inherent Filtration	0.8mmAL Eq. @70kV
	Added Filtration	0.5mmAL
	<i>Cone Filtration</i>	<i>1.5 mmAl Eq. @70kV</i>
	Total Filtration	2.8mm AL Eq. @ 70 kV
CONE Length (from focal spot)		200mm(60 kV, 70kV)
Material of CONE		PB, ABS
Language		English
Weight	Main body	Total 1.6 kg \pm 10% (Cone 200mm 260g \pm 10%)
	Cradle	540g \pm 10%

7.2.2 X-ray Generator

Item		Specifications
High Voltage Generator (Assembly)	Model	NRG1
	Rated output power	Max. 0.21 kW
	Duty Cycle	1:30 or more (Exposure time: Interval time)
	Cooling Protection	Thermistor ≥ 70 °C
	Type	Inverter Type
	Tube Voltage	55 - 65 kV / 65-75kV
	Tube Current	2.6 - 3.4 mA
X-ray Tube	Manufacturer	Hangzhou Kailong Medical Instrument Co., Ltd
	Model	KL-11-0.4-70
	Focal spot size	0.4 mm (IEC 60336)
	Anode heat contents	4.5 kJ
	Maximum Anode Heat Dissipation	110 W
	Target Material	Tungsten
	Target Angle	12°
	Inherent Filtration	Min. 0.8 mm Al / 75kV
	X-ray Coverage	70 mm at SID 200 mm
	Tube Voltage	70 kV
	Tube Current	Max. 12.0 mA

7.2.3 X-ray Tube Characteristics

1) Maximum rating chart

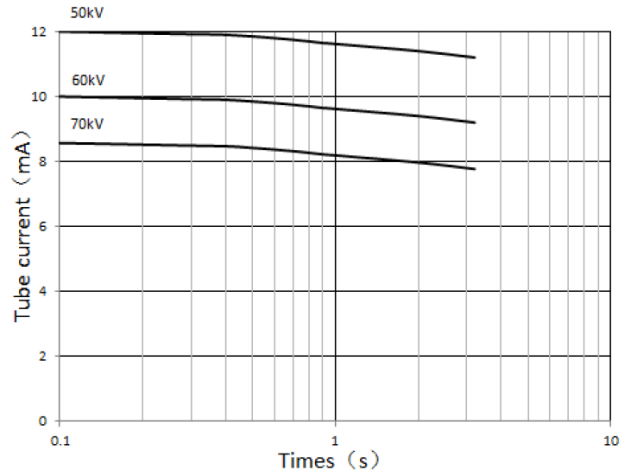

2) Emission characteristics

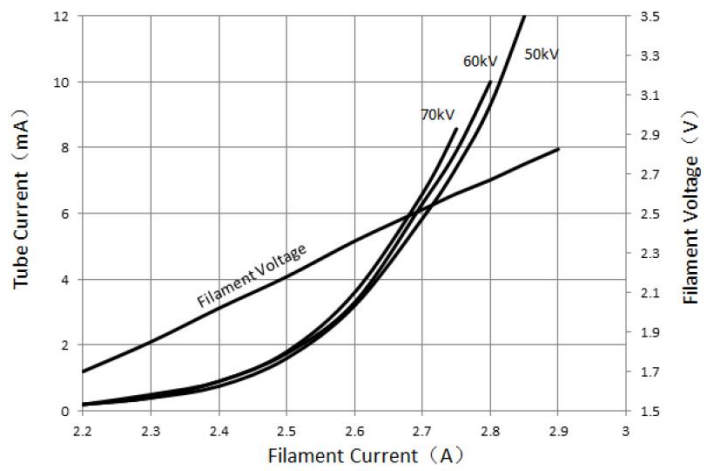

3) Heating and cooling curves of X-ray tube

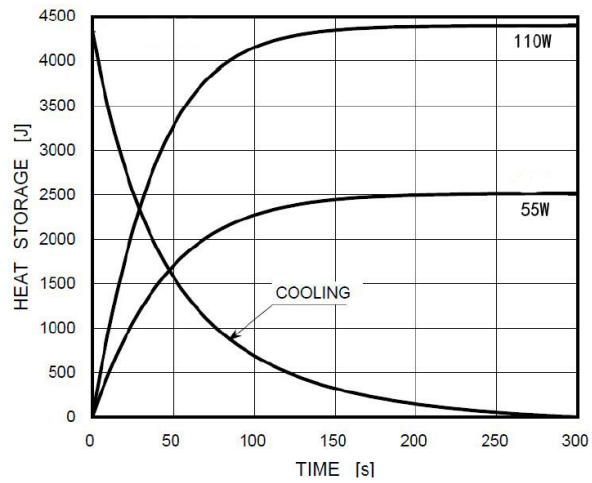

4) Tube Dimensions [mm]

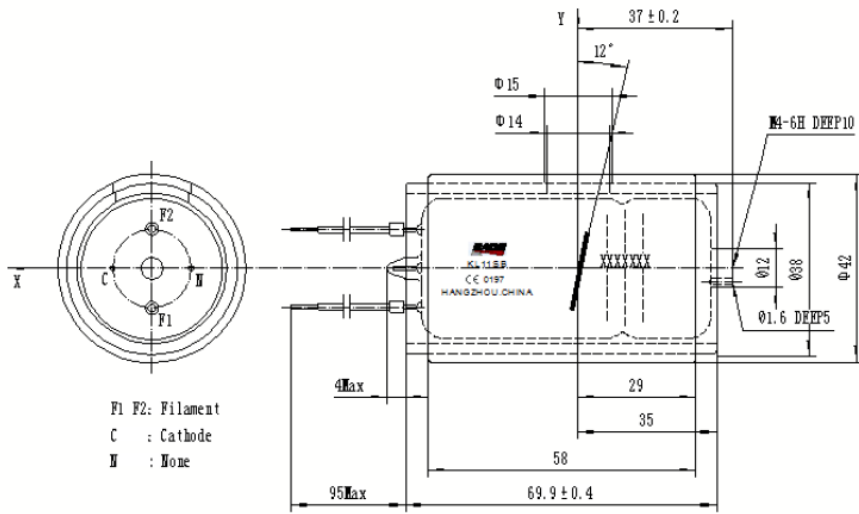

F1 F2: Filament
 C : Cathode
 N : None

X axis :horizontal Y axis :vertical

OUTLINE DRAWING
 (KL11SB-0.4-70)

7.2.4 Battery

Item	Description
Type	Super Capacitor
Nominal Capacity	120 F
Nominal Voltage	2.8 V d.c. 4 by 2
Charging Voltage	10.8 V d.c. (2.8 V d.c./Cell)
Discharge Voltage	9 - 11.2 V d.c.



Super Capacitor is consumable, so periodic replacement (500,000 cycle) is recommended. (warranty period: 3years)

7.2.5 Cradle (Power cord included)

Item	Description
Model	SW60-120050000-W
Manufacturer	POWER-TEK
Rating	Input: 100 - 240 V~, 50 - 60 Hz, 1.5 A
	Output: 12 V d.c., 5 A
Frequency	50 - 60 Hz
Standard	IEC 60950-1 (UL)
Power Cord	250 V~, 16 A

7.3 Electrical Specifications

Item	Description
Tube Voltage	70 kV/ 60KV fixed (± 10%)
Tube Current	3 mA (± 20 %)
Exposure Time	0.01 - 1.0 s (±5% or ±20ms)
Rated Voltage	10.8 V d.c.

7.4 Environmental Specifications

















Item		Description
During operating	Temperature	10 ~ 35 °C
	Relative humidity	30 ~ 75 %
	Atmospheric pressure	860 ~ 1060 hPa
Transport and storage	Temperature	-10 ~ 60 °C
	Relative humidity	10 ~ 75 % non-condensing
	Atmospheric pressure	860 ~ 1060 hPa

















8. Appendix

8.1 Tables of Exposure Times (Default)

The following exposure time tables were established with a unit equipped with a cone that corresponds to a focus-to-skin distance of 200 mm (8 inch) respectively.

We can use it with DR, CR, Film type detectors, the exposure Times according to the type are as follow table.

Patient	Teeth	Angle of inclination	SSD: 200 mm (8 inch)			
			kV	mA	s	
Adult 	dr	Incisor 	Maxilla: +45° Mandible: -25°	60/70	3	0.08
		Canine 	Maxilla: +45° Mandible: -20°	60/70	3	0.10
		Upper Molar 	Maxilla: +30°	60/70	3	0.12
		Lower Molar 	Mandible: -5°	60/70	3	0.15
		Bitewing 	+5° ~ +8°	60/70	3	0.18
	cr	Incisor 	Maxilla: +45° Mandible: -25°	60/70	3	0.20
		Canine 	Maxilla: +45° Mandible: -20°	60/70	3	0.24
		Upper Molar 	Maxilla: +30°	60/70	3	0.28
		Lower Molar 	Mandible: -5°	60/70	3	0.32
		Bitewing 	+5° ~ +8°	60/70	3	0.36
	FL	Incisor 	Maxilla: +45° Mandible: -25°	60/70	3	0.40
		Canine 	Maxilla: +45° Mandible: -20°	60/70	3	0.44
		Upper Molar 	Maxilla: +30°	60/70	3	0.48
		Lower Molar 	Mandible: -5°	60/70	3	0.52
		Bitewing 	+5° ~ +8°	60/70	3	0.56

Patient		Teeth		Angle of inclination	SSD: 200 mm (8 inch)		
					kV	mA	s
Child 	dr	Incisor		Maxilla: +45° Mandible: -25°	60/70	3	0.06
		Canine		Maxilla: +45° Mandible: -20°	60/70	3	0.08
		Upper Molar		Maxilla: +30°	60/70	3	0.10
		Lower Molar		Mandible: -5°	60/70	3	0.12
		Bitewing		+5° ~ +8°	60/70	3	0.15
	cr	Incisor		Maxilla: +45° Mandible: -25°	60/70	3	0.16
		Canine		Maxilla: +45° Mandible: -20°	60/70	3	0.20
		Upper Molar		Maxilla: +30°	60/70	3	0.24
		Lower Molar		Mandible: -5°	60/70	3	0.28
		Bitewing		+5° ~ +8°	60/70	3	0.32
	FL	Incisor		Maxilla: +45° Mandible: -25°	60/70	3	0.30
		Canine		Maxilla: +45° Mandible: -20°	60/70	3	0.34
		Upper Molar		Maxilla: +30°	60/70	3	0.38
		Lower Molar		Mandible: -5°	60/70	3	0.42
		Bitewing		+5° ~ +8°	60/70	3	0.46

8.2 X-ray Dose Data

The X-ray dose data is extracted from the X-ray Dose Test Report for the NR-F300. The X-ray doses of the NR-F300 in the test report were measured in accordance with the IEC collateral standards. The NR-F300 was designed in accordance with Part 1. General Requirements for Safety, IEC 60601-1-3.

Test Condition	
Model Name	NR-F300
Tube Model Name	KL-11-0.4-70
Generator Model Name	NRG1-
Loading Factor	60kV / 70 kV, 3 mA

8.2.1 X-ray Dose Table

Test Equipment			
Instrument	Manufacturer	Model	S/N
Dose Meter	Ray-safe	X2 Base Unit	225575

Dose Table (70 kVp, 3 mA, FOV: Ø 6 cm, SSD 200 mm, at Al 6 mm)	
t (s)	Dose (µGy)
0.06	56
0.10	93
0.14	129
0.20	182
0.34	302
0.5	436
0.6	515
0.8	665
1.0	810

8.2.2 Leakage Dose

Scope

IEC 60601-2-65 203.12.4

Requirements

In the LOADING STATE, the AIR KERMA due to LEAKAGE RADIATION from X-RAY SOURCE ASSEMBLIES, 1 m from the FOCAL SPOT, average over any area of 100 cm² of which no principal linear dimension exceeds 20 cm, when operated at the NOMINAL X-RAY TUBE VOLTAGE under condition of LOADING corresponding to the reference LOADING conditions, shall not exceed 0.2 mGy in one hour.

Leakage Dose	Permissive Range
70 kVp, 3 mA, 1.0 s (Max. Exposure Condition) At Focal Spot to Distance 1 m 1 : 30 Duty Cycle	< 0.2 mGy/h

Results

The following exposure time tables were established with a unit equipped with a cone that corresponds to a focus-to-skin distance of 200 mm (8 inch) respectively. When the leakage doses have been measured with each cover type (default, rectangular 2x3, and rectangular 4x3), all the results have been ND (Not Detected).

The raw data about the results is shown in the table below. (exposure time : 160 ms)

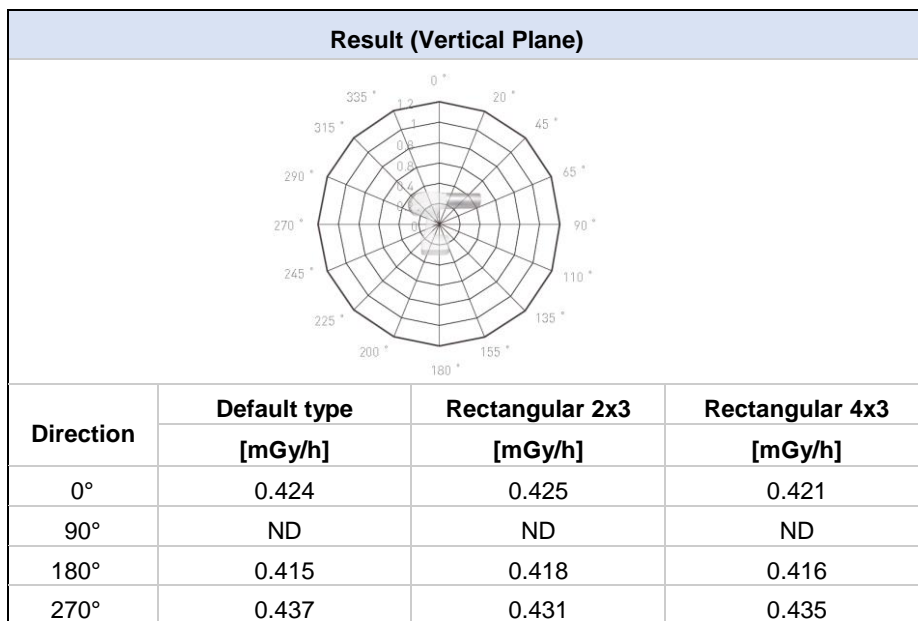
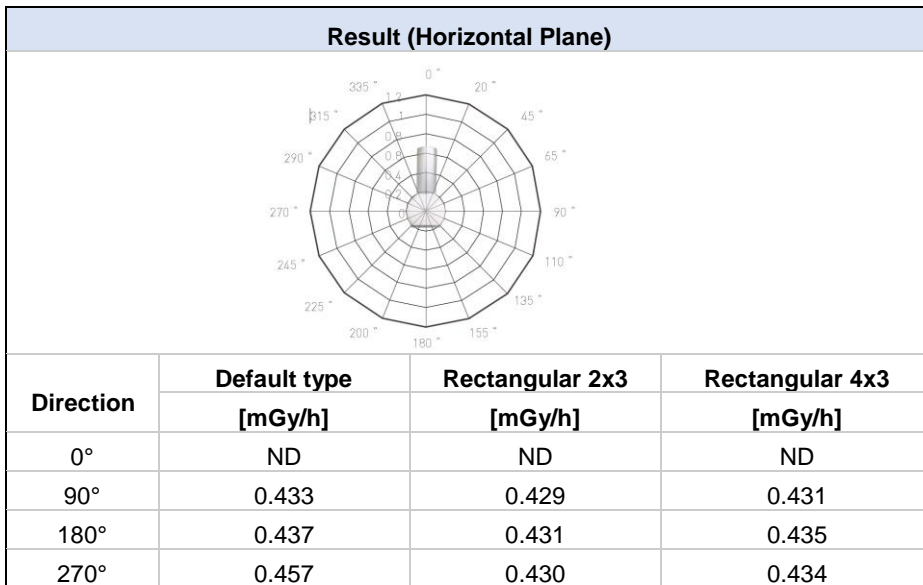

ND: Not Detected. Detection limit is 0.00001 mGy per exposure.

8.2.3 Scattered Dose

Scope

IEC 60601-2-65 203.12.2

Requirements

ME EQUIPMENT shall be provided with means to optionally allow actuation of the IRRADIATION from a PROTECTED AREA after installation.

Relevant instructions shall be given in the ACCOMPANYING DOCUMENTS.

Results

The following exposure time tables were established with a unit equipped with a cone that corresponds to a focus-to-skin distance of 200 mm (8 inch) respectively.

Method
PMMA Phantom aligned to 280 mm away from Focal Spot (with Position Indicating Device) Max. Exposure Condition : 70 kVp / 3mA / 1 s Measure point : 500 mm from PMMA Phantom

Direction [°]	Result(Horizontal plane) [μ R/s]
0 °	78.6
20 °	33.4
45 °	38.2
65 °	24.4
90 °	41.4
110 °	48.4
135 °	54.1
155 °	10.6
180 °	2.8
200 °	14.8
225 °	48.3
245 °	47.8
270 °	43.1
290 °	20.7
315 °	31.3
335 °	36.5

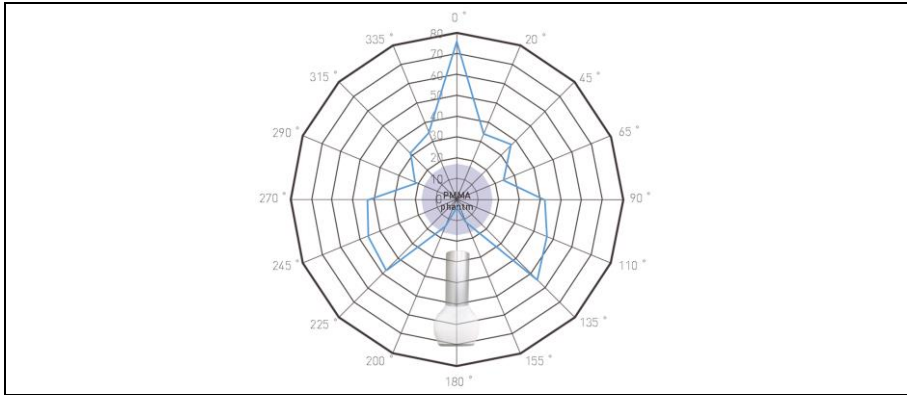

Direction [°]	Result(Vertical plane) [μR/s]
0 °	43.8
20 °	21.4
45 °	32.1
65 °	36.2
90 °	77.2
110 °	33.1
135 °	33.6
155 °	24.7
180 °	42.0
200 °	46.1
225 °	40.7
245 °	12.9
270 °	3.2
290 °	13.4
315 °	38.6
335 °	44.5

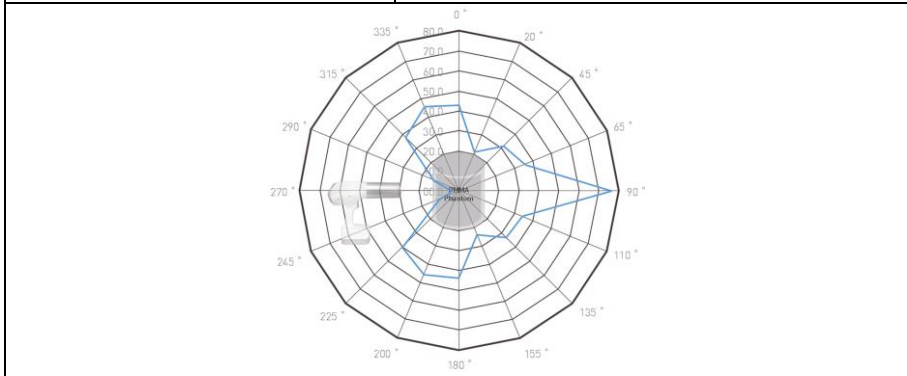

8.3 Electromagnetic Compatibility (EMC) Information

Guidance and manufacturer's declaration - electromagnetic emissions

The NR-F300 is intended for use in the electromagnetic environment specified below. The customer or the user of the NR-F300 should assure that it is used in such an environment.		
Emissions test	Compliance	Electromagnetic environment - guidance
RF-emissions KN 11/CISPR 11	Group 1	The NR-F300 uses RF energy only for its internal function. Therefore, its RF emissions are very low and are not likely to cause any interference in nearby electronic equipment.
RF-emissions KN 11/CISPR 11	Class A	The NR-F300 is suitable for use in all establishments other than domestic, and may be used in domestic establishments and those directly connected to the public low-voltage power supply network that supplies buildings used for domestic purposes, Provided the following warning is heeded:
Harmonic emissions Acc. IEC 61000-3-2	Compliance	
Voltage fluctuations/ Flicker emissions Acc. IEC 61000-3-3	Compliance	Warning: This NR-F300 is intended for use by healthcare professionals only. This equipment/system may cause radio interference or may disrupt the operation of nearby equipment. It may be necessary to take mitigation measures, such as re-orienting or relocating the NR-F300 or shielding the location.

Guidance and manufacturer's declaration - electromagnetic immunity

The NR-F300 is intended for use in the electromagnetic environment specified below. The customer or the user of the NR-F300 should assure that it is used in such an environment.			
Immunity test	IEC 60601 Test level	Compliance level	Electromagnetic environment -guidance
Electrostatic discharge (ESD) IEC 61000-4-2:2009	±8 kV Contact ±2,4,8,15 kV air	±8 kV Contact ±15 kV air	Floors should be wood, concrete or ceramic tile. If floors are covered with synthetic material, the relative humidity should be at least 30 %.
Electrical fast transient/burst IEC 61000-4-4:2012	± 2 kV 100 kHz repetition frequency	± 2 kV 100 kHz repetition frequency	Main power quality should be that of a typical commercial or hospital environment.
Surge IEC 61000-4-5:2014	± 0,5 kV, ± 1 kV	± 1 kV	Main power quality should be that of a typical commercial or hospital environment.
Voltage dips, short interruptions and voltage variations on power supply input lines IEC 61000-4-11	0 % UT; 0,5 cycle At 0° , 45° , 90° , 135° , 180° , 225° , 270° and 315°	0 % UT; 0,5 cycle At 0° , 45° , 90° , 135° , 180° , 225° , 270° and 315°	Main power quality should be that of a typical commercial or hospital environment. If the user of the NR-F300 image intensifier requires continued operation during power mains interruptions, it is recommended that the NR-F300 image intensifier be powered from an uninterruptible power supply.
	0 % UT; 1 cycle and 70 % UT; 25/30 cycles Single phase: at 0°	0 % UT; 1 cycle and 70 % UT; 25/30 cycles Single phase: at 0°	
Power frequency (50/60 Hz) magnetic field IEC 61000-4-8:2009	30 A/m	30 A/m	Power frequency magnetic fields should be at levels characteristic of a typical location in a typical commercial or hospital environment.
NOTE) U _T is the a.c. mains voltage prior to application of the test level.			

Guidance and manufacturer's declaration - electromagnetic immunity

The NR-F300 is intended for use in the electromagnetic environment specified below. The customer or the user of the NR-F300 should assure that it is used in such an electromagnetic environment.

Immunity test	IEC 60601 test level	Compliance level	Electromagnetic environment - guidance
Conducted RF IEC 61000-4-6 Radiated RF IEC 61000-4-3	3 V 0,15 MHz – 80 MHz 6 V in ISM bands between 0,15 MHz and 80 MHz 80 % AM at 1 kHz 3 V/m 80 MHz – 2,7 GHz 80 % AM at 1 kHz	3 V 0,15 MHz – 80 MHz 6 V in ISM bands between 0,15 MHz and 80 MHz 80 % AM at 1 kHz 3 V/m 80 MHz – 2,7 GHz 80 % AM at 1 kHz	Portable mobile RF communications equipment should be used no closer to any part of the NR-F300, including cables, than the recommended separation distance calculated from the equation applicable to the frequency of the transmitter. Recommended separation distance $d = \left[\frac{3,5}{V_1} \right] \sqrt{P}$ $d = \left[\frac{3,5}{E_1} \right] \sqrt{P}$ 80 MHz to 800 MHz $d = \left[\frac{7}{E_1} \right] \sqrt{P}$ 800 MHz to 2.7 GHz GHz Where <i>P</i> is the maximum output power rating of the transmitter in watts (W) according to the transmitter manufacturer and <i>d</i> is the recommended separation distance in meters (m). Field strengths from fixed RF transmitters, as determined by an electromagnetic site survey, ^a should be less than the compliance level in each frequency range. ^b Interference may occur in the vicinity of equipment marked with the following symbol: 

NOTE 1) At 80 MHz and 800 MHz, the higher frequency range applies.

NOTE 2) These guidelines may not apply in all situations. Electromagnetic propagation is affected by absorption and reflection from structures, objects and people.

- ^a Field strength from fixed transmitters, such as base stations for radio (cellular/cordless) telephones and land mobile radios, amateur radio, AM and FM radio broadcast and TV broadcast cannot be predicted theoretically with accuracy. To assess the electromagnetic environment due to fixed RF transmitters, an electromagnetic site survey should be considered. If the measured field strength outside the shielded location in which the NR-F300 is used exceeds the applicable RF compliance level above, the NR-F300 should be observed to verify normal operation. If abnormal performance is observed, additional measures may be necessary, such as re-orienting or relocating the NR-F300.
- ^b Over the frequency range 150kHz to 80MHz, field strengths should be less than 3 V/m.

Recommended separation distances between portable and mobile RF communications equipment and the NR-F300

This is intended for use in an electromagnetic environment in which radiated RF disturbances are controlled. The customer or the user of the NR-F300 can help prevent electromagnetic interference by maintaining a minimum distance between portable and mobile RF communications equipment (transmitters) and the NR-F300 as recommended below, according to the maximum output power of the communications equipment.

Rated maximum output power of transmitter [W]	Separation distance according to frequency of transmitter [m]		
	150 kHz to 80 MHz $d = \left[\frac{3,5}{V_1} \right] \sqrt{P}$	80 MHz to 800 MHz $d = \left[\frac{3,5}{E_1} \right] \sqrt{P}$	800 MHz to 2.7 GHz $d = \left[\frac{7}{E_1} \right] \sqrt{P}$
0.01	0.12	0.12	0.23
0.1	0.38	0.38	0.73
1	1.2	1.2	2.3
10	3.8	3.8	7.3
100	12	12	23

For transmitters rated at a maximum output power not listed above, the recommended separation distance d in meters (m) can be determined using the equation applicable to the frequency of the transmitter, where P is the maximum output power rating of the transmitter in watts (W) according to the transmitter manufacturer.

NOTE 1) At 80 MHz and 800 MHz, the separation distance for the higher frequency range applies.

NOTE 2) These guidelines may not apply in all situations. Electromagnetic propagation is affected by absorption and reflection from structures, objects and people.

8.4 Abbreviations

Acronym	Name
AL	Aluminum
EMC	Electromagnetic Compatibility
ESD	Electrostatic Discharge
FOV	Field of View
IEC	International Electro technical Commission
ISO	International Standards Organization
LED	Light-Emitting Diode
ME	Medical Electrical
PMMA	PolyMethylMethAcrylate
RF	Radio Frequency
SID	Source to Image receptor Distance
SIP	Signal Input Part
SOP	Signal Output Part
SSD	Source to Skin Distance

Thank you very much for choosing The Ray as your X-ray solution. We would like to hear your valuable comments, due to your feedback or suggestions are important to us. If you have opinion, please contact to us on the below email or phone.

Copyright by © 2018 NANORAY Co., Ltd.

All rights reserved.

The documentation, brand name and logo used in this manual are copyrighted.

No part of this manual may be reproduced, transmitted, or transcribed without the expressed written permission of the manufacturer.

We reserve the right to make any alterations which may be required due to technical improvement. For the most current information, contact your NANORAY representative.

Manufactured by NANORAY Co., Ltd.

Tel: (+82) 53 962 4900

Email: service@nano-ray.com

Website: www.nano-ray.com



Head Quarters : 601-604, 88, Dongnae-ro, Dong-gu, Daegu, Rep. of Korea

Factory : 401, 402, 403, 408, 409, 76, Dongnae-ro, Dong-gu, Daegu, Korea



NANORAY Co., Ltd.

401, 402, 403, 408, 409, 76, Dongnae-ro, Dong-gu, Daegu, Korea

	The CE symbol grants this product compliance to the European Directive for Medical Devices 93/42/EEC as amended by 2007/47/EC as a class IIb device.
	CALMED INVEST Kft. (HU11678179) Attila utca 34., Budapest, 1191, Hungary Tel)+36-1+291-5066 Fax)+36-1-291-0366