

ANTOLOGIE
DENTICS DENTAL 2019

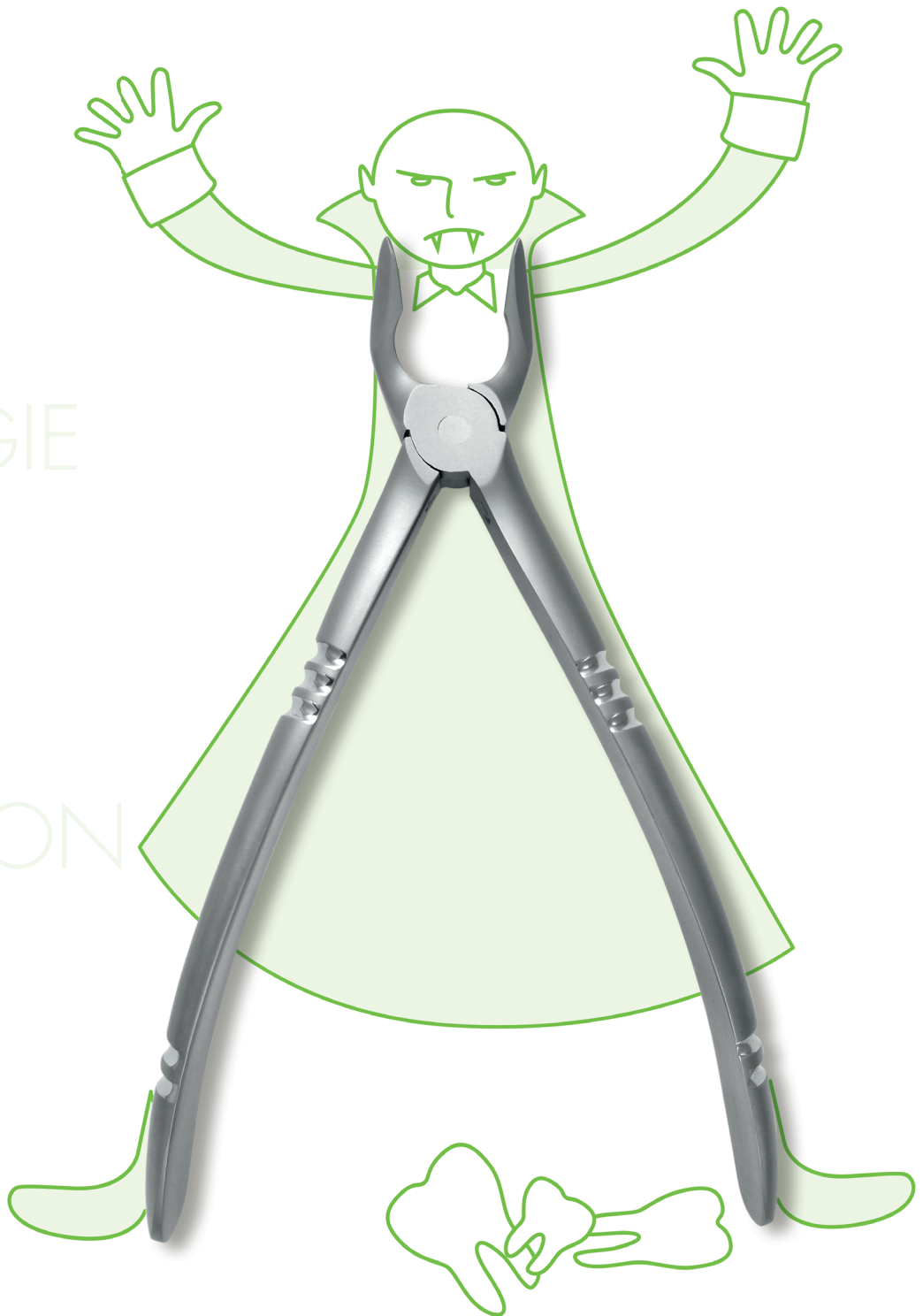

TREATMENT
NG
ONTIA
IE
RGERY
CHIRURGIE
ODES
KTRODEN
ON
TERILISATION



IMPLANTOLOGY
DENTAL 2019 IMPLANTOLOGY
DIAGNOSTICS ORTHODONTICS
DIAGNOSTIK KIEFERORTHOPÄDIE
CONSERVATIVE TREATMENT
KONSERVIERENDE BEHANDLUNG
PERIODONTIA
PARODONTOLOGIE
EXTRACTION DENTAL SURGERY
EXTRAKTION DENTALE CHIRURGIE
IMPRESSION TRAYS DENTAL ELECTRODES
ABDRUCKLÖFFEL DENTAL-ELEKTRODEN
STORAGE & STERILIZATION
AUFBEWAHRUNG & STERILISATION
PROTHETIK PROSTHETICS



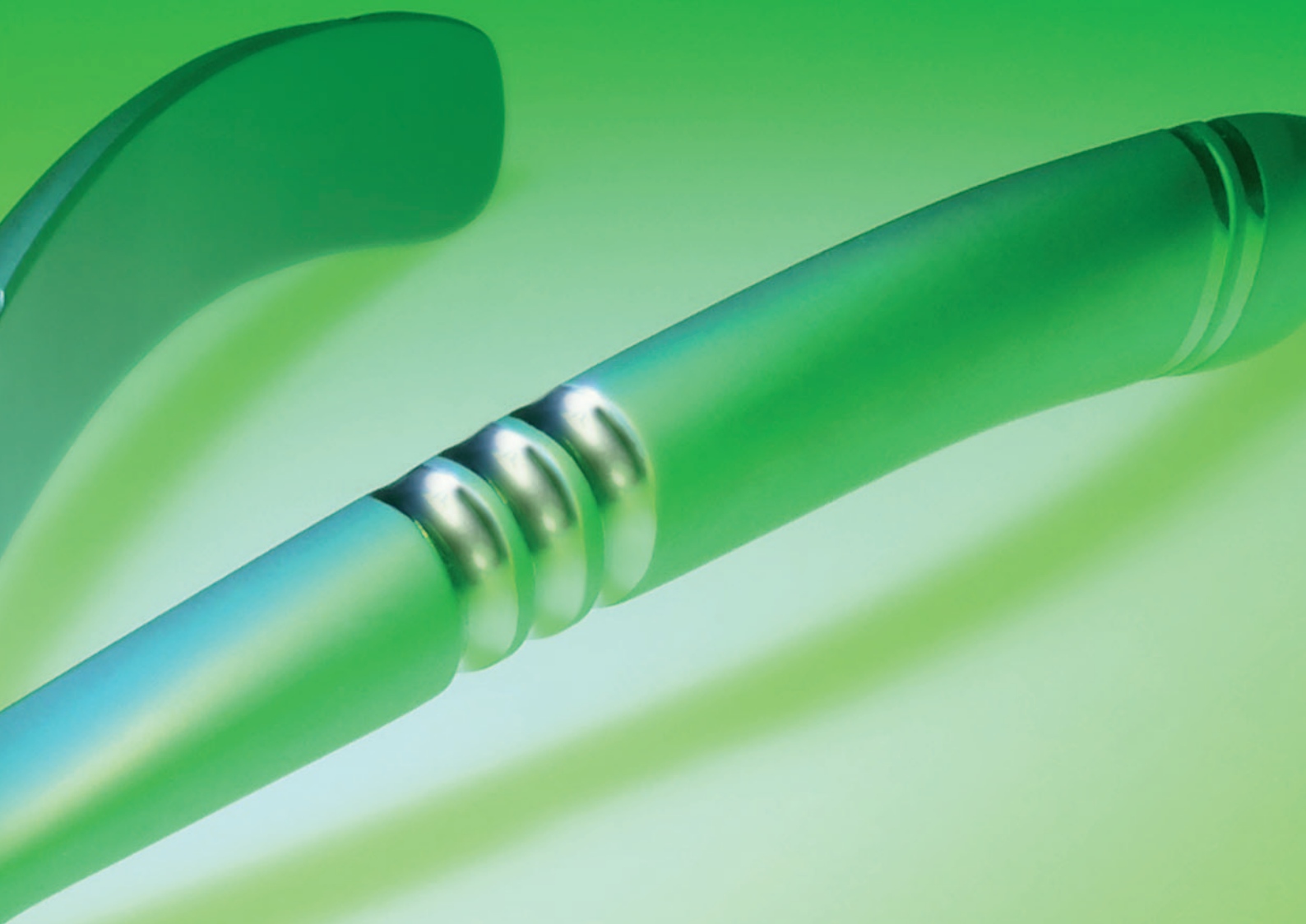

OTTO **LEIBINGER**
L-DENT

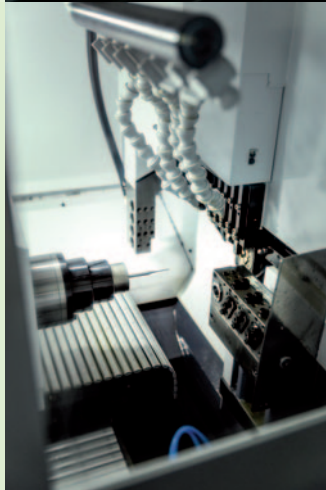
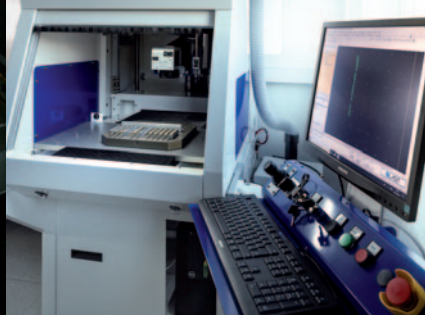
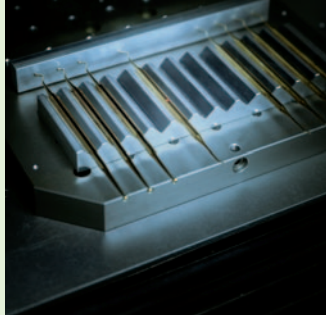



Tina Leibinger-Toth

EXPERIENCE IN QUALITY

OTTO LEIBINGER GmbH was established in 1978. Its founder and namesake comes from a family with a long tradition in instrument manufacture. Our location in Mühlheim near Tuttlingen provides the best conditions for manufacturing high-quality dental hand instruments as the world's centre for medical technology.

In collaborating with us, customers greatly appreciate our flexibility and service strengths. With direct, personal care and a solution-oriented way of thinking and handling, we set the course for a long-term, cooperative partnership.

MIT QUALITÄT KENNEN WIR UNS AUS

Die OTTO LEIBINGER GmbH besteht seit 1978. Ihr Gründer und Namensgeber stammt aus einer Familie, in der die Instrumentenherstellung eine lange Tradition hat. Auch unser Standort, Mühlheim bei Tuttlingen, bringt als Weltzentrum der Medizintechnik beste Voraussetzungen für die Herstellung von hochwertigen Dental-Handinstrumenten mit sich.

In der Zusammenarbeit wissen Kunden unsere Flexibilität und Servicestärke zu schätzen. Mit persönlicher Betreuung, kurzen Wegen und einem lösungsorientierten Denken und Handeln stellen wir die Weichen für ein langfristiges, partnerschaftliches Miteinander.

DIAGNOSTICS
DIAGNOSTIK

CONSERVATIVE TREATMENT
KONSERVIERENDE BEHANDLUNG

ENDODONTICS
ENDODONTIE

PERIODONTICS
PARODONTOLOGIE

EXTRACTION
EXTRAKTION

DENTAL SURGERY
DENTALE CHIRURGIE

DENTAL ELECTRODES
DENTAL-ELEKTRODEN

IMPRESSION TRAYS
ABDRUCKLÖFFEL

IMPLANTOLOGY
IMPLANTOLOGIE

STORAGE & STERILIZATION
AUFBEWAHRUNG & STERILISATION

PROSTHETICS
PROTHETIK



Please also check our
ORTHODONTICS catalogue!

Bitte fragen Sie auch nach
unserem KFO-Katalog!

RANGE OF PRODUCTS

Our extensive array of products ranges from dental hand instruments currently in use, such as instruments for fillings and periodontal treatment, through to instruments for dental surgery and dental technology laboratories. We offer everything from one source. All products manufactured by ourselves or from selected suppliers undergo systematic and stringent quality control. This is how we guarantee for the consistent high quality of every single instrument supplied by OTTO LEIBINGER.

DAS PRODUKTSPEKTRUM

Unser umfangreiches Programm reicht weit über die gängigen dentalen Handinstrumente und Instrumente für die dentale Chirurgie bzw. das Zahntechnik-Labor hinaus. Wir bieten alles aus einer Hand. Sowohl die Produkte aus eigener Herstellung als auch die von ausgewählten Lieferanten zugekauften Teile unterliegen konsequent unseren strengen Kontrollen und Prüfverfahren. So wird die gleichbleibend hohe Qualität gesichert, die jedes einzelne Instrument aus dem Hause OTTO LEIBINGER auszeichnet.

DIAGNOSTICS

- Tweezers
 - Explorers
 - Mirrors and Mirror Handles
 - Perio Probes
-

CONSERVATIVE TREATMENT

- Filling Instruments
 - Burnishers
 - Excavators
 - Gingival Margin Trimmers
 - Compo-Fill Instruments
 - Carving Instruments
 - Cement Spatulas
 - Amalgam Carriers
 - Matrix Retainers
-

ENDODONTICS

- Endo Excavators
 - Root Canal Instruments
 - Rubberdam Instruments
-

PERIODONTICS

- Gracey Curettes
 - Scalers
 - Gingivectomy Knives
 - Perio Files
 - Chisels
 - Raspatories
-

EXTRACTION

- Extracting Forceps english pattern
 - Extracting Forceps child pattern
 - Extracting Forceps american pattern
 - Root Elevators
-

DENTAL SURGERY

- Cartridge Syringe
 - Retractors
 - Mallets, Chisels, Raspatories
 - Bone Files, Periostomes
 - Suction Tubes
 - Tweezers
 - Scissors
 - Needle Holders
 - Bone Rongeurs
 - Haemostatic Forceps
 - Scalpel Handles
-

DENTAL ELECTRODES

IMPRESSION TRAYS

IMPLANTOLOGY

- Sinus Lift Curettes
 - Osteotomes
 - Bone Measuring Instruments
 - Bone Grafting Instruments
 - Micro Surgery Instruments
 - Titanium Curettes
-

STORAGE & STERILIZATION

PROSTHETICS

- Steamer Net Richter
 - Waxing Instruments
 - Plaster Knives, Plaster Spatulas
 - Calipers
 - Crown Remover
-

DIAGNOSTIK

- Pinzetten
 - Zahnsonden
 - Mundspiegel + Griffe
 - Parodontalsonden
-

KONSERVIERENDE BEHANDLUNG

- Füllungsinstrumente
 - Polierinstrumente
 - Exkavatoren
 - Gingivalrandschräger
 - Compo-Fill Instrumente
 - Modellierinstrumente
 - Zementspatel
 - Amalgampistolen
 - Matrizenspanner
-

ENDODONTIE

- Endo-Exkavatoren
 - Wurzelkanalinstrumente
 - Kofferdam Instrumente
-

PARODONTOLOGIE

- Gracey Küretten
 - Scaler
 - Gingivektomie Messer
 - Parodontalfeilen
 - Meißel
 - Raspatorien
-

EXTRAKTION

- Zahnzangen englische Form
 - Kinderzahnzangen
 - Zahnzangen amerikanische Form
 - Wurzelheber
-

DENTALE CHIRURGIE

- Zylinder Ampullen Spritze
 - Mund- und Wundhaken
 - Hämmer, Meißel, Raspatorien
 - Knochenfeilen, Periotome
 - Saugrohre
 - Pinzetten
 - Scheren
 - Nadelhalter
 - Hohlmeißelzangen
 - Arterienklemmen
 - Skalpellgriffe
-

DENTAL-ELEKTRODEN

ABDRUCKLÖFFEL

IMPLANTOLOGIE

- Sinus Lift Küretten
 - Osteotome
 - Knochenmessinstrumente
 - Instrumente für die Knochengewinnung
 - Mikroinstrumente
 - Titanküretten
-

AUFBEWAHRUNG & STERILISATION

PROTHETIK

- Abdampfnetz Richter
 - Modellierinstrumente
 - Gipsmesser, Gipsspatel
 - Tasterzirkel, Gußküvetten
 - Kronenabnehmer
-



Fig.1 100/1 101/1 102/1	Fig.2 100/2 101/2 102/2	Fig.3 100/3 101/3 102/3	Fig.3A 100/3A 101/3A 102/3A	Fig.6 100/6 101/6	Fig.8 100/8 101/8 102/8 103/8	Fig.9 100/9 101/9 102/9 103/9	Fig.11 100/11 101/11 102/11 103/11
			NEW 122/3A-ED	122/6-ED	122/8-ED	122/9-ED	122/11-ED



Fig.17 100/17 101/17 102/17 103/17	Fig.23 100/23 101/23 102/23 103/23	Fig.35 101/35 102/35 103/35
--	--	--------------------------------------

NEW 122/17-ED 122/23-ED

- » Special pattern on request - minimum qty 20 pcs
- » Sondermodelle auf Anfrage ab 20 Stück

Ø 8 mm
hollow, light
hohl, extra leicht

100/...

101/...

102/...

103/...

122/...-ED

ERGODESIGN



105/...

107/...

123/...-ED

Ø 8 mm
hollow, light
hohl, extra leicht



Fig. 2
105/2
107/2

Fig. 5
105/5
107/5

Fig. 8-9
105/8-9
107/8-9

Fig. 9
105/9
107/9

Fig. 11
105/11
107/11

NEW

123/5-ED

123/8-9-ED

123/11-ED

» with fine and flexible but strong tips
» mit feinen flexiblen Spitzen federhart

ERGODESIGN



Fig.8 104/8	Fig.9 104/9	Fig.11 104/11	Fig.17 104/17	Fig.23 104/23
----------------	----------------	------------------	------------------	------------------

explorer tips with thread
Sondenspitzen mit Gewinde

» All Tips suitable for handles on page 9
» Alle Einsätze passend zu den Griffen von Seite 9

MICROMIRRORS FS RHODIUM
MIKROSPIEGEL FS RHODIUM



Ø 3 mm 201/10	Ø 5 mm 201/20	3 x 6 mm 201/30
------------------	------------------	--------------------



plane
plan
200/08

magnifying
hohl
200/06



200/8

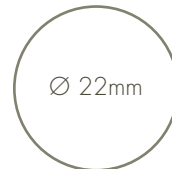

200/6

200/12

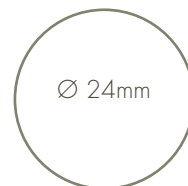

200/11

» All mirrors available with Front Surface. Please add „FS“ to the item code.
» Alle Spiegel mit „Front Surface“ erhältlich. Bitte ergänzen Sie die Artikelnummer mit „FS“.

BOX WITH 12 PCS
12 STÜCK PRO EINHEIT

» Suitable handles
for explorers and
mirrors on page 8

» Passende Griffe für
Sonden und Spiegel
von Seite 8



hollow, chromium plated
hohl, verchromt
200/1



hollow, stainless
hohl, rostfrei
200/2



hollow stainless
hohl, rostfrei
200/3



hollow, stainless
hohl, rostfrei
200/4

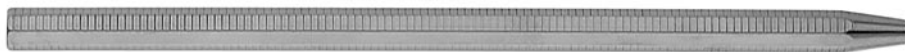

solid stainless
massiv, rostfrei
200/5



ERGODESIGN
ERGODESIGN
200/51



ENDO-SPECIAL
ENDODONTIE-SPEZIAL

ERGODESIGN with measuring scale (0-30mm)
ERGODESIGN mit Messskala am Griff (0-30mm)
200/51M

FURCATION PROBE
FURKATIONS-SONDE

1-2-3-5-7-8-9-10



1-2-3-5-7-8-9-10
flat flach



WILLIAMS 23W
405/23W
without
color coding
ohne
Farbmarkierungen

GOLDMAN-FOX-WILLIAMS
405/PGW
without
color coding
ohne
Farbmarkierungen

NABERS 2N
405/2N

NABERS 2N
405/2NC-V
color coded
farbcodiert



ED

» special color coating, not fading after sterilization
 » spezielle biokompatible Farbbeschichtung, die nicht verblasst



1-2-3-5-7-8-9-10

WILLIAMS
 without color coding
 ohne Farbmarkierungen
 405/W
 405/W-ED



1-2-3-5-7-8-9-10

CP10
 405/CP10



1-2-3-5-7-8-9-10
 flat flach

GOLDMAN-FOX PGF
 405/PGF



3-6-8-11

CP11
 405/CP11



3-6-9-12

CP12
 405/CP12
 405/CP12-ED



2-4-6-8-10-12

NEW CP22N
 405/CP22N
 405/CP22N-ED

1-2-3-4-5-6-7-8-9
 10-11-12-13-14-15



CP15
 405/CP15
 405/CP15-ED

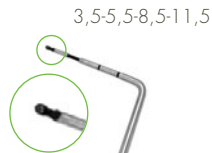

3,5-5,5-8,5-11,5

WHO
 405/WHO
 405/WHO-ED

3,5-5,5-8,5-11,5



WHO
 405/WHO-T-ED

TiN coated
 to be used on implants
 mit TiN Beschichtung
 für die Verwendung
 an Implantaten



LONDON
COLLEGE

180/5



LONDON
COLLEGE

diamond coated
diamantiert
180/5D



LONDON
COLLEGE

with lock
mit Schloss
180/6



LONDON
COLLEGE

smooth handle
glatter Griff
180/10



Endo Locking Tweezers

Endo-Pinzette
mit Schloss
15cm
180/68



MILLER

Articulating paper forceps
Artikulationspapier
Pinzette
180/1



PERRY

180/8



MERIAM

180/9



Suture Tweezers

Nahtpinzette
15cm
181/4

HANDLES GRIFFE

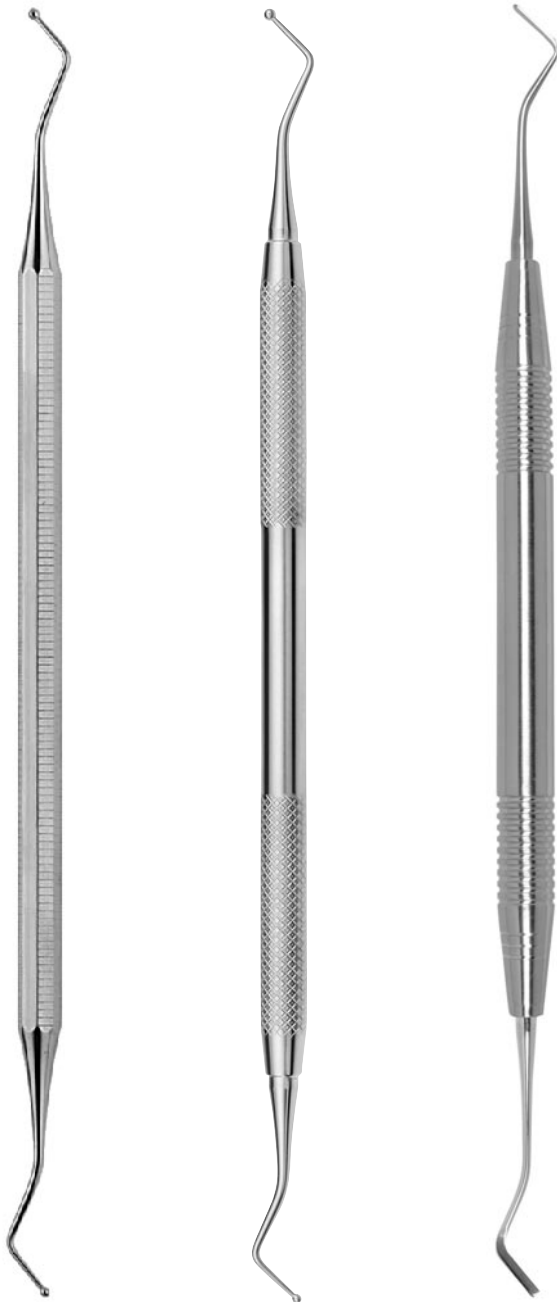

Octagonal handle
Achtkant-Griff
Ø 5,5mm

Round handle solid
Rundgriff massiv
Ø 6mm

ERGODESIGN
ERGODESIGN
Ø 8mm

ERGODESIGN HANDLE

- Ergonomic shape for comfortable and non-exhausting working even over a long period
- Ø 8mm, extra light
- Safe grip even during working with wet hands or gloves because of the special serration
- Modern and shapely design
- Easy cleaning

ERGODESIGN GRIFF

- Ergonomische Form für komfortables und ermüdungsfreies Arbeiten
- Ø 8mm, extra leicht
- Sicherer Grip auch beim Arbeiten mit Handschuhen und feuchten Händen durch die rutschhemmende Riffelung
- Formschönes und modernes Design
- Problemlose Reinigung

Octagonal handle
Achtkant-Griff
Ø 5,5mm

Round handle solid
Rundgriff massiv
Ø 6mm

ERGODESIGN
ERGODESIGN
Ø 8mm



0,8	1,2	2,0	2,6	1,0	1,6
1,0	1,6	2,5	3,0	2,0	2,0
110/1 ●	110/2 ●	110/3 ●	110/4 ●	110/5 ●	110/6 ●
110/1-ED ◎	110/2R ●	110/3-ED ◎			
	110/2-ED ◎				

1,6	2,9	2,7	0,6	0,6	1,0
2,5	3,6	3,2	0,9	0,9	0,8
110/7 ●	110/8 ●	110/9 ●	DYCAL 110/0 ●	DYCAL 110/OK ●	110/CHP ●

CALCIUM HYDROXIDE PLACER
CALCIUM HYDROXYD PLATZIERINSTRUMENT

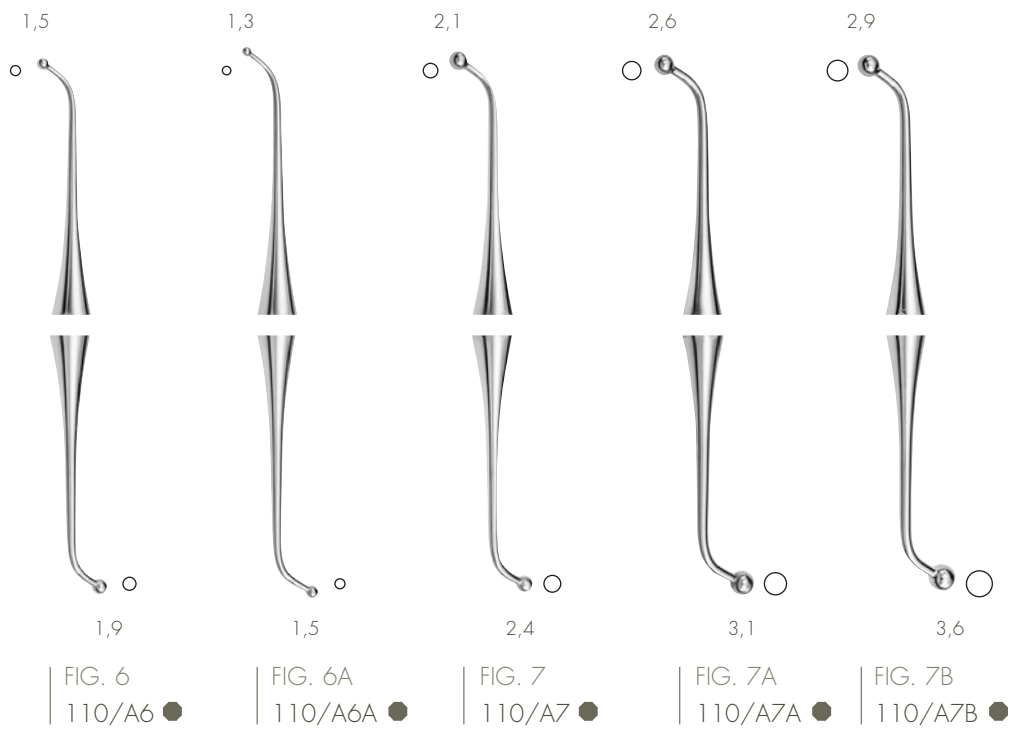
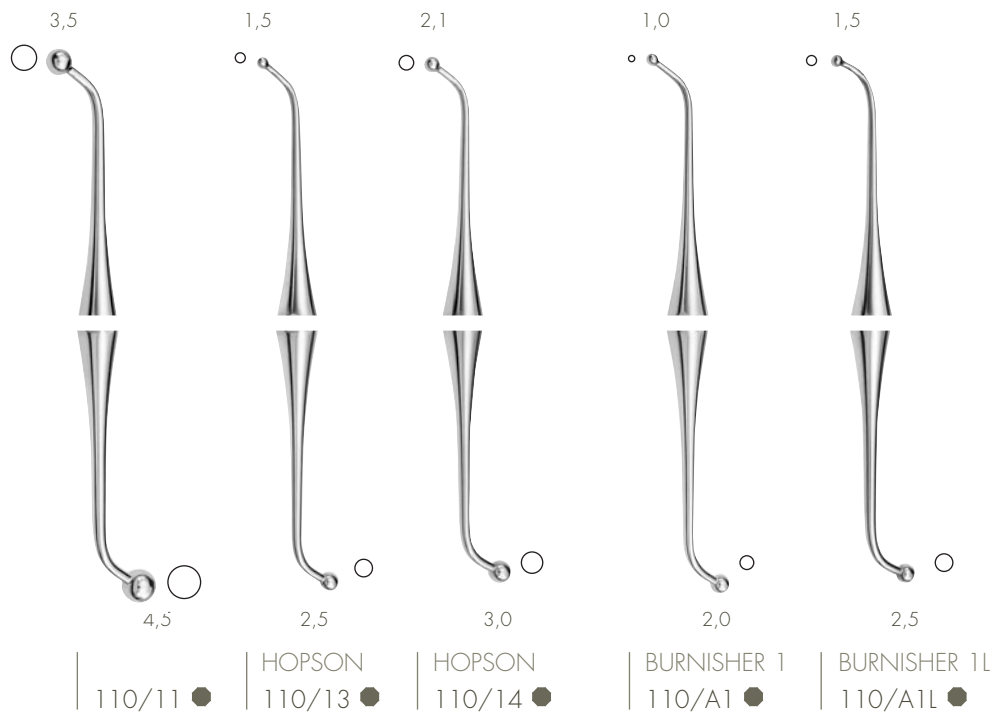



BURNISHER/SPATULA KUGEL/SPATEL

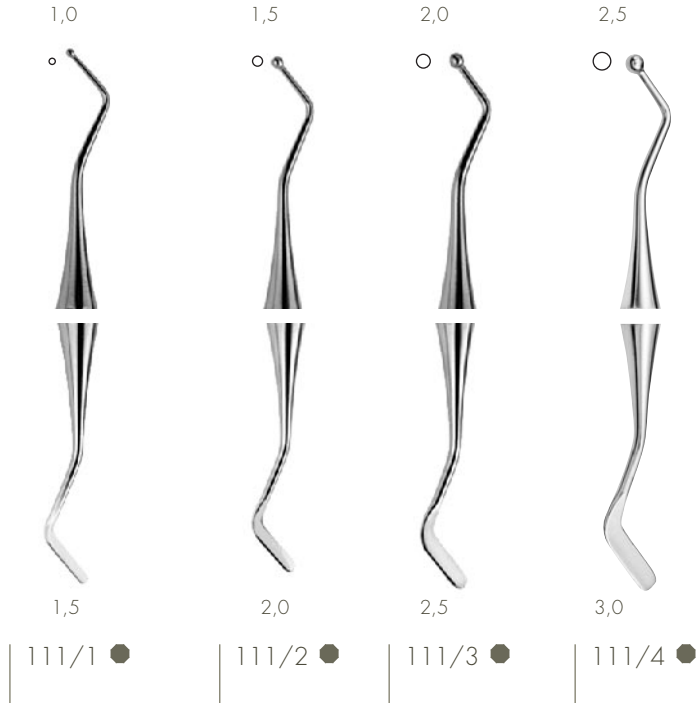

PEAR SHAPED BIRNFORM

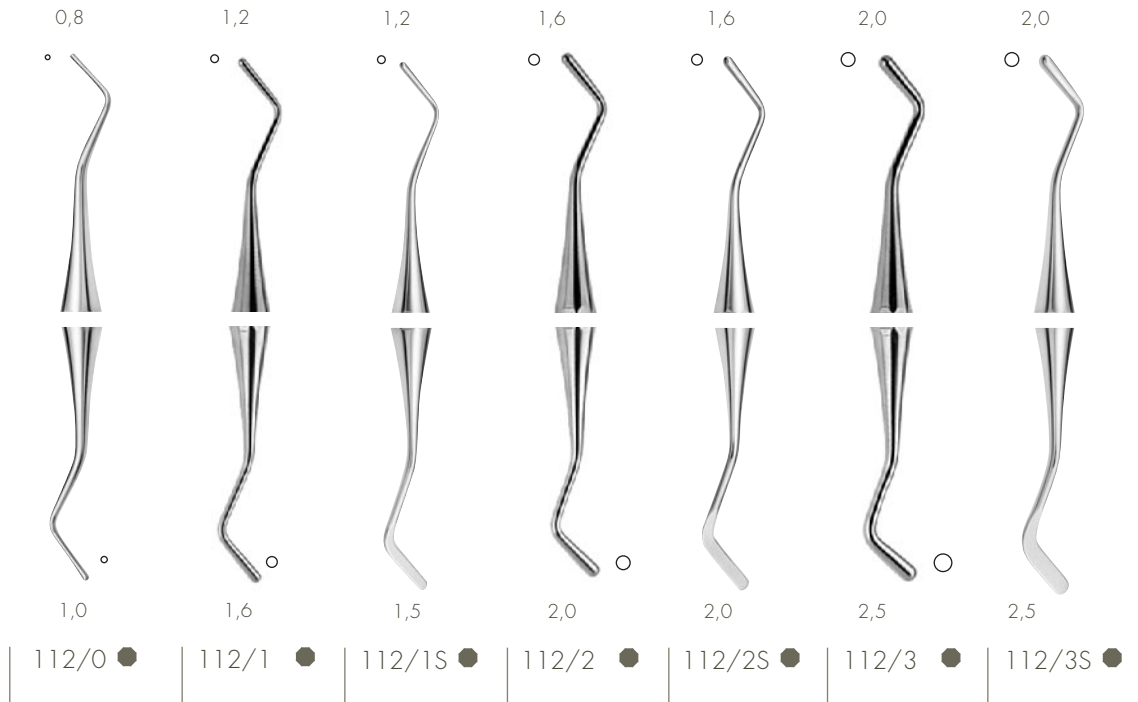

PLUGGER STOPFER

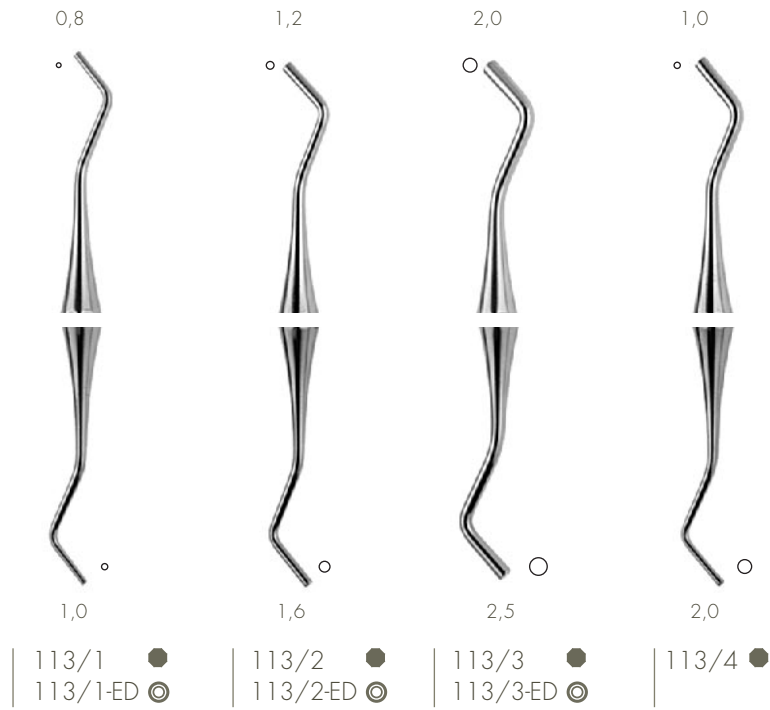

» You did not find your preferred instrument? We manufacture according to your specification!

» Sie haben Ihr Wunschmodell nicht gefunden? Wir fertigen nach Ihren Vorgaben!



Octagonal handle
Achtkant-Griff
Ø 5,5mm

Round handle solid
Rundgriff massiv
Ø 6mm

ERGODESIGN
ERGODESIGN
Ø 8mm



1,0



1,0

114/0 ●

1,5



1,5

114/1 ●
114/1-ED ◎

2,0



2,0

114/2 ●
114/2-ED ◎

2,5

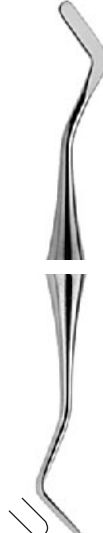

2,5

114/3 ●
114/3-ED ◎

3,2



3,2

114/4 ●

2,2



2,5

114/6 ●

1,5

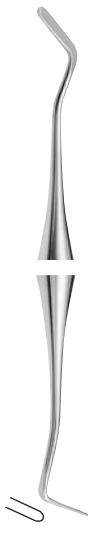

1,5

114/P8A ●
114/P8AR ●

2,0

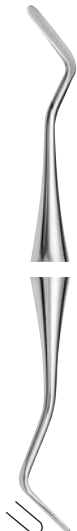

2,0

114/P4 ●
114/P4R ●
114/P4-ED ◎

2,0



1,1

114/P6 ●
114/P6R ●
114/P6-ED ◎

1,6



1,1

114/PFI1 ●

2,0



1,6

114/PFI3 ●

2,0



2,2

114/PFI14 ●

1,5



2,0

114/PFI15 ●
114/PFI15-ED ◎

2,0



1,5

114/PFI109 ●
114/PFI109-ED ◎

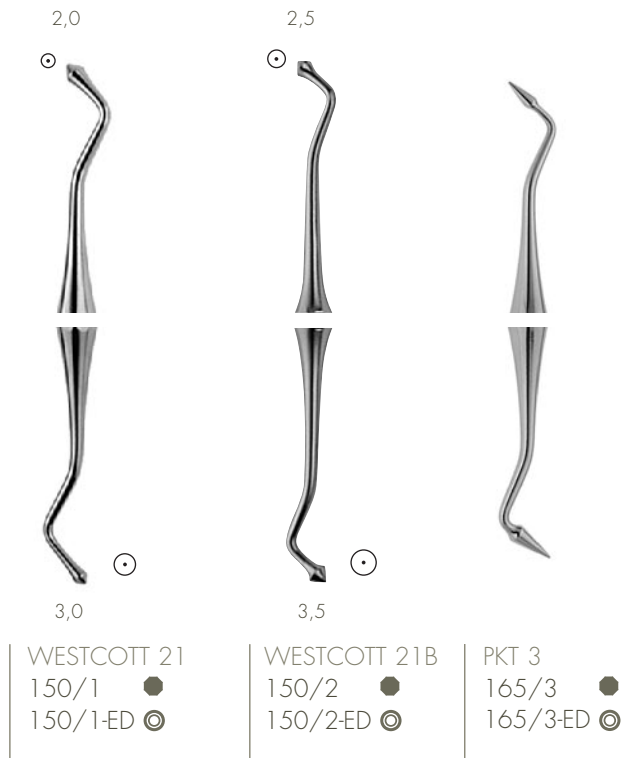
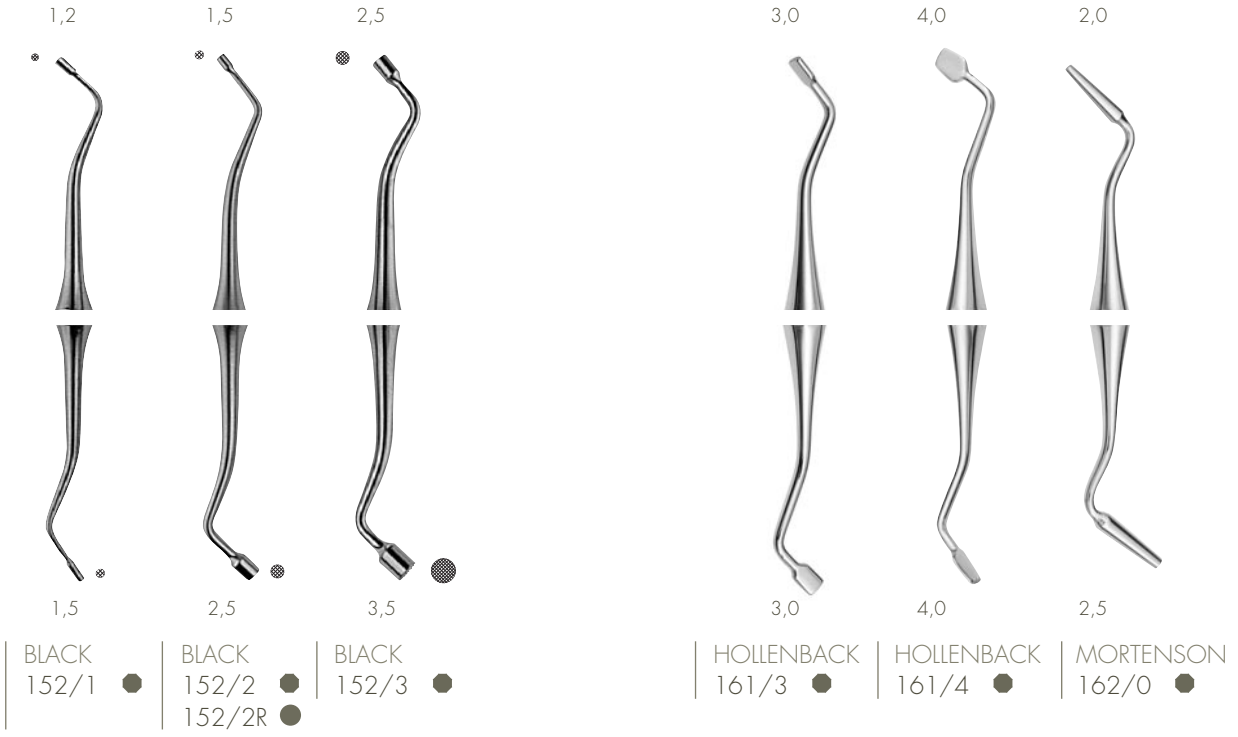

Octagonal handle
Achtkant-Griff
Ø 5,5mm

Round handle solid
Rundgriff massiv
Ø 6mm



150/B1 ●
150/B1R ●



WHITE
150/29-31 ●



WHITE
150/34-29 ●
150/34-29R ●



WHITE 28
150/28 ●



WHITE 31
150/31 ●



150/PI ●
150/PIR ●

ENDO EXCAVATORS ENDO EXKAVATOREN

1,0

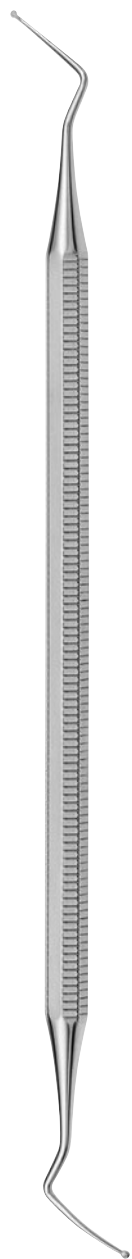

134/31L ●
135/31L ●

1,5

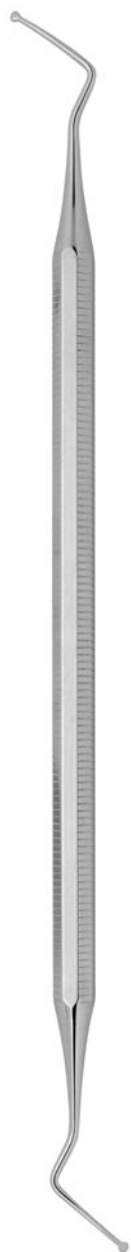

134/32L ●
135/32L ●

2,0

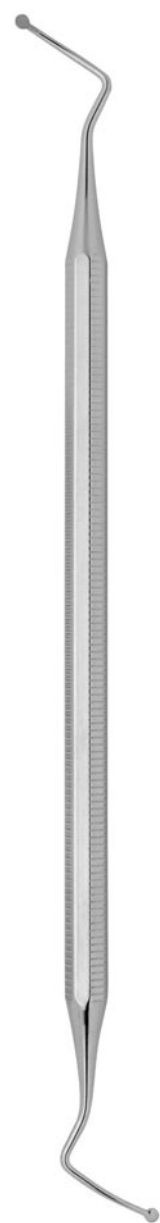

134/33L ●
135/33L ●



135/PT55 ●



GLICK
134/GL2 ●
135/GL2 ●

Octagonal handle
Achtkant-Griff
Ø 5,5mm

Round handle solid
Rundgriff massiv
Ø 6mm



	1,7	2,1	1,1	1,5	2,0
	134/14 ● 135/14 ●	DARBY-PERRY 220/221 134/15 ● 135/15 ●	134/S11 ● 135/S11 ●	134/S15 ● 135/S15 ●	134/S20 ● 135/S20 ●
	1,5	1,5	1,7	2,5	
	EXC 5 134/16 ● 135/16 ●	EXC 17 134/17 ● 135/17 ●	EXC 18 134/18 ● 135/18 ●	EXC 19 134/19 ● 135/19 ●	



1,1



133/134
134/09 ●
135/09 ●

1,3



131/132
134/10 ●
135/10 ●

2,1



125/126
134/11 ●
135/11 ●

1,7



127/128
134/12 ●
135/12 ●

1,5



129/130
134/13 ●
135/13 ●

1,6



159/160
135/21 ●

1,4



243
135/729 ●

1,8



244
135/730 ●

2,0



245
135/731 ●



Ø 8mm, extra light safe grip handles
Ø 8mm, extra leicht, rutschsichere Griffenden

ERGODESIGN

Our COMPO-FILL instruments have a special high mirror polished TiN (Titanium Nitrid) coating that avoids the sticking of the composite material on the working tips. This TiN-Coating is a lot more harder than stainless steel and withstands therefore diverse cleaning and sterilization processes.

Unsere COMPO-FILL Instrumente haben eine spezielle hochglanzpolierte TiN (Titan-Nitrid) Beschichtung, die das Festkleben des Composites an den Arbeitsenden verhindert. Die Beschichtung ist sehr viel härter als Edelstahl und dadurch auch sehr resistent gegen die verschiedenen Reinigungs- und Sterilisationsprozesse.

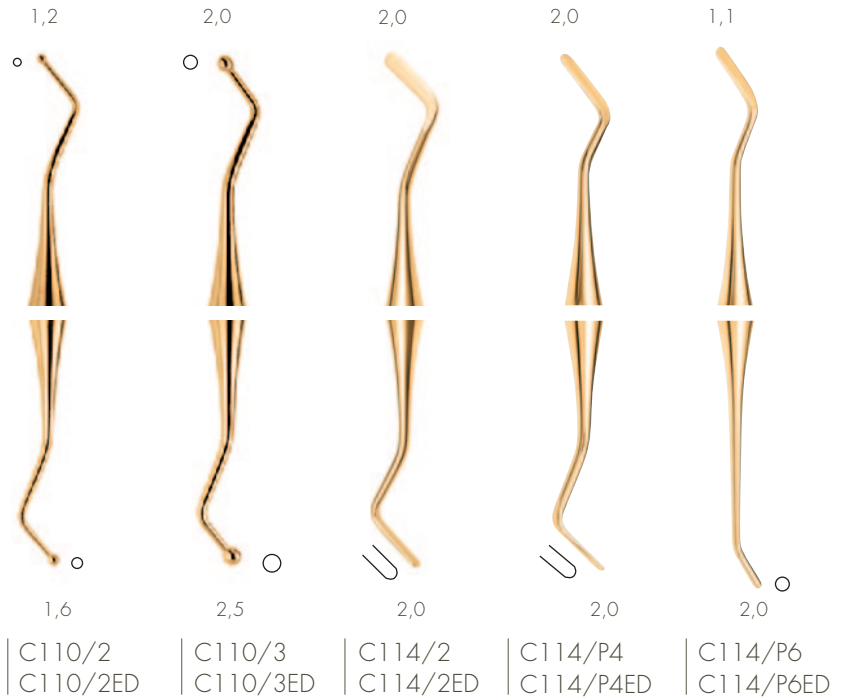

ED = with ERGODESIGN Handle
ED = mit ERGODESIGN Griff

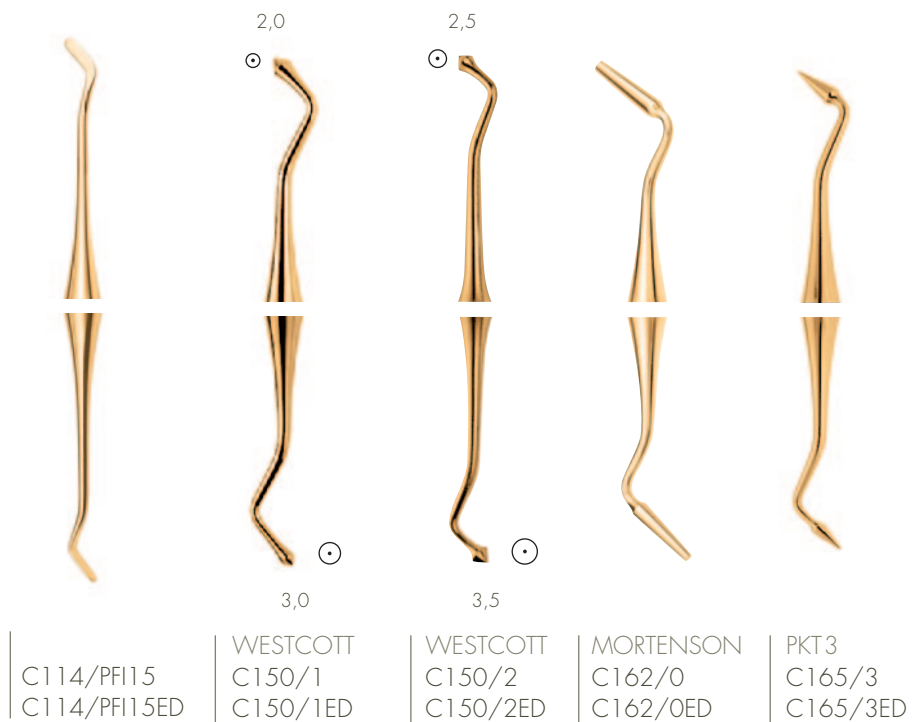

COMPOFILL-SET also available with ERGODESIGN handle

C110/2	C110/2-ED	Compo-Fill Filling Instrument
C110/3	C110/3-ED	Compo-Fill Filling Instrument
C114/2	C114/2-ED	Compo-Fill Filling Instrument
C114/P4	C114/P4-ED	Compo-Fill Instrument No.4
C114/P6	C114/P6-ED	Compo-Fill Instrument No.6
C114/PFI15	C114/PFI15-ED	Plastic Filling Instrument No. 15
C150/1	C150/1-ED	Compo-Fill Finishing Instrument Westcott
C150/2	C150/2-ED	Compo-Fill Finishing Instrument Westcott
C162/0	C162/0-ED	CompoFill Filling Instrument Mortenson
C165/3	C165/3-ED	Compo Fill Carving Instrument
500/T	500/T	Wash Tray with Silicon Inlay for storage of 10 instruments 184 x 150 x 25mm

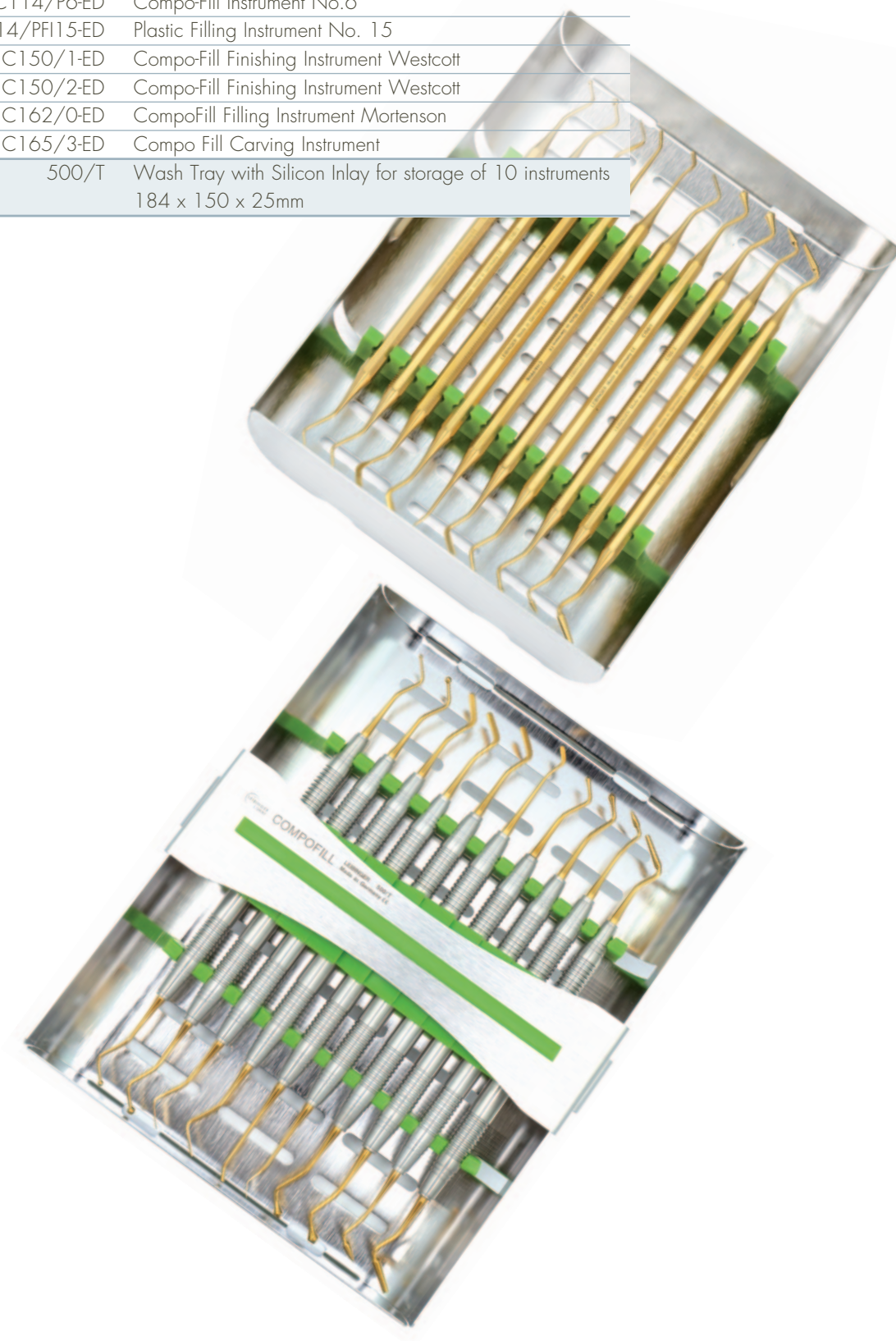

CEMENT SPATULAS ZEMENTSPATEL



| 140/1



| 140/2



| 140/3

FLEXIBLE

Octagonal handle
Achtkant-Griff
Ø 5,5mm

Round handle solid
Rundgriff massiv
Ø 6mm

ERGODESIGN
ERGODESIGN
Ø 8mm

BESTSELLER

HEIDEMANN

2,0



2,0

2,5



2,5

3,0



3,0

» soft flexible tips
» flexible
Arbeitsenden

116/0 ●	116/1 ●	116/2 ●
116/OR ●	116/1R ●	116/2R ●
116/0-ED ◎	116/1-ED ◎	116/2-ED ◎

Also available as COMPO-FILL with TiN coating
Auch erhältlich als COMPO-FILL mit TiN Beschichtung

C116/0 ●	C116/1 ●	C116/2 ●
C116/0-ED ◎	C116/1-ED ◎	C116/2-ED ◎

Octagonal handle
Achtkant-Griff
Ø 5,5mm

Round handle solid
Rundgriff massiv
Ø 6mm

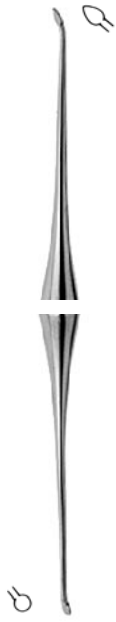

DISCOID CLEOID
89/92

160/1 ●
162/1 ●

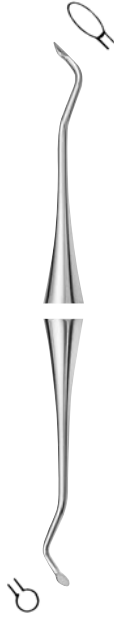

DISCOID CLEOID
3/6

160/3-6 ●
162/3-6 ●



HOLLENBACK
1/2

160/H12 ●
161/H12 ●



HOLLENBACK
3

160/H3 ●
161/H3 ●



HOLLENBACK
3S

160/H3S ●
161/H3S ●



INTERPROXIMAL

160/J2 ●
162/J2 ●



FRAHM

160/73 ●



FRAHM

160/74 ●



FRAHM

160/78 ●



WILAND

160/W ●
161/W ●



WARD

160/W1 ●



WARD

160/W2 ●



LUNIATSCHEK
Gauze Packers
Tamponstopfer
117/1



NYSTROEM
173/2 ●

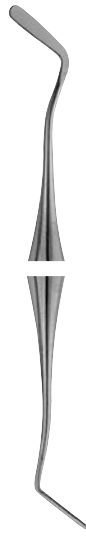

Cord Packer
Fadenstopfer
serrated gezahnt
173/4 ●



non-serrated
ungezahnt
173/5 ●

0,5–1,0mm
173/6 ●

0,7–1,2mm
173/7 ●



BEALE
162/7A ●



Filling Remover
Füllungsentferner
double ended
doppelendig
170/1 ●



Gingival Margin Trimmer
Gingivalrandschräger
distal
173/28 ●
173/28R ●



mesial
173/29 ●
173/29R ●



TOFFLEMIRE
Universal
320/1



TOFFLEMIRE
Junior
320/2



TOFFLEMIRE
Senior
320/3



30°
with metal tip
mit Metallspitze
145/30



45°
with metal tip
mit Metallspitze
145/45



85°
with metal tip
mit Metallspitze
145/85

RUBBER DAM INSTRUMENTS KOFFERDAM INSTRUMENTE



316/SET
RUBBER DAM SET

CONTENT

- 1 Frame for children
- 1 Frame for adults
- 1 Rubber Dam Punch
- 1 Clamp Holding Forceps
- 8 Clamps Fig. 00, 2, 2A, 7, 8, 8A, 9, 14A
- 1 Clamp Board

KOFFERDAM SET

INHALT

- 1 Rahmen für Kinder
- 1 Rahmen für Erwachsene
- 1 Lochzange
- 1 Klammerzange
- 8 Klammern Fig. 00, 2, 2A, 7, 8, 8A, 9, 14A
- 1 Halter für Klammern

RUBBER DAM CLAMPS

KOFFERDAM KLAMMERN



316/RDC0
for longer premolars
für obere und untere Prämolaren



316/RDC13A
for lower molars, left
für untere Molaren, links



316/RDC00
lower canines and premolars
untere Eckzähne und Prämolaren



316/RDC14
for molars
für Molaren



316/RDC1
for upper premolars
für obere Prämolaren



316/RDC14A
for big molars
für große Molaren



316/RDC10
small molars upper left /lower right
kleine Molaren links oben u.rechts unten



316/RDC15
for lower molars, large
für untere Molaren, groß



316/RDC10A
for upper and lower molars
für obere und untere Molaren



316/RDC2
upper and lower premolars
obere und untere Prämolaren



316/RDC11
small molars upper right / lower left
kleine Molaren links unten u.rechts oben



316/RDC200
big clamps for lower molars
große Klammern für untere Molaren



316/RDC12
for upper and lower molars
für obere und untere Molaren



316/RDC201
for upper molars
für obere Molaren



316/RDC12A
lower molars left and right
untere Molaren rechts und links



316/RDC203
small clamps for left molars
kleine Klammern f. linke Molaren



316/RDC204
small clamps for right molars
kleine Klammern f. rechte Molaren



316/RDC205
large clamps for upper molars
grosse Klammern für obere Molaren



316/RDC4
for small upper molars
für kleine obere Molaren



316/RDC206
for lower molars
für untere Molaren



316/RDC5
large clamps for upper molars
grosse Klammern für obere Molaren



316/RDC212
for labial cavities on anterior teeth
für labiale Karies an Frontzähnen



316/RDC56
for big molars
für große Molaren



316/RDC22
for upper and lower premolars
für obere und untere Prämolaren



316/RDC7
for lower molars
für untere Molaren



316/RDC23
for upper and lower molars
für obere und untere Molaren



316/RDC7A
for large lower molars
für große untere Molaren



316/RDC26N
for upper molars
für obere Molaren



316/RDC8
large clamps for upper molars
grosse Klammern für obere Molaren



316/RDC2A
for upper and lower premolars
für obere und untere Prämolaren



316/RDC8A
for roots of lower and upper molars
für Wurzeln v. oberen u. unteren Molaren



316/RDC3
for lower molars
für untere Molaren



316/RDC9
for anterior teeth
für Frontzähne

316/01
Set of 8 Rubber Dam Clamps incl. Board
Fig.00 lower canines and premolars
Fig.2 upper and lower premolars
Fig.2A upper and lower premolars
Fig.7 lower molars
Fig.8 upper molars
Fig.8A roots of upper and lower molars
Fig.9 bicuspid
Fig.14A big molars

Set mit 8 Kofferdam Klammern inkl. Halterung
Fig.00 untere Eckzähne und Prämolaren
Fig.2 obere und untere Prämolaren
Fig.2A obere und untere Prämolaren
Fig.7 untere Molaren
Fig.8 obere Molaren
Fig.8A Wurzeln von oberen und unteren Molare
Fig.9 Frontzähne
Fig.14A große Molaren

316/00
Board without clamps
Halterung ohne Klammern

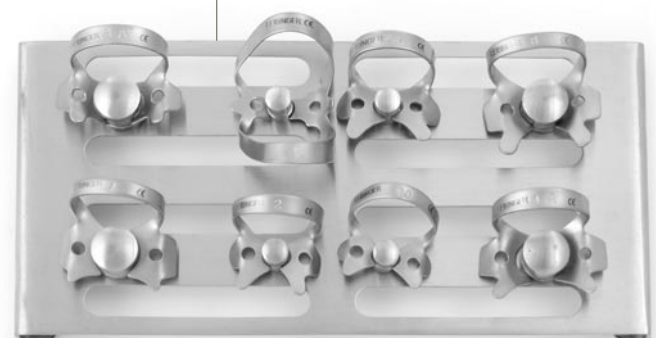



AINSWORTH, 17cm
Rubberdam Punch
Kofferdam-Lochzange
315/1



IVORY, 16cm
Rubberdam Punch
Kofferdam-Lochzange
315/2



STOKE, 17cm
Rubberdam Clamp Forceps
Kofferdam-Klammerzange
315/3



IVORY, 17cm
Rubberdam Clamp Forceps
Kofferdam-Klammerzange
315/4



BREWER, 17cm
Rubberdam Clamp Forceps
Kofferdam-Klammerzange
315/5

ENDODONTIC TWEEZERS ENDOTONTIE-PINZETTEN

» very fine tips
» extrem feine Spitzen

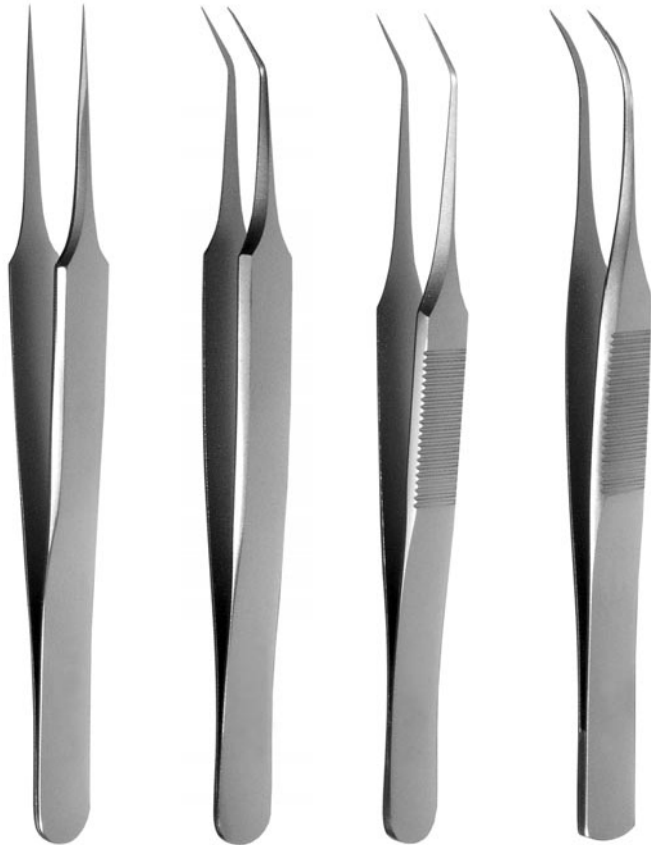

[110mm
184/41

[110mm
184/42

[110mm
184/43

[110mm
184/44



Endodontic Forceps
Wurzelkanalzange
610/5

Suture Tweezers
Nahtpinzette
15cm
181/4

Endo Locking
Tweezers
Endo-Pinzette
mit Schloss
15cm
180/68

0.20



Spreader
Spreizer
118/S20

0.30

0.40

0.50



118/S30



118/S40



118/S50

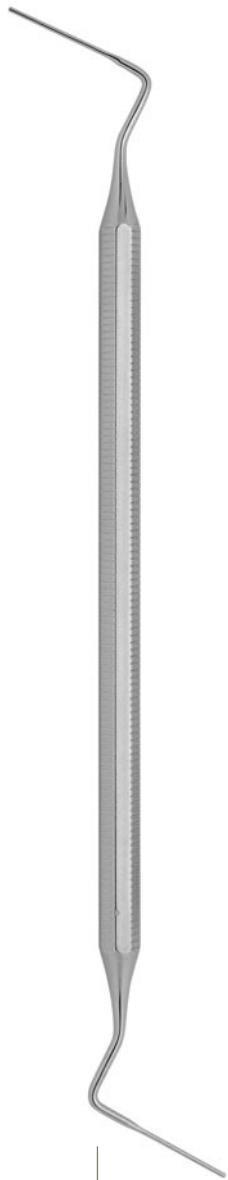

BUCHANAN
Plugger
Stopfer
0,7mm
118/B1

1,0mm
118/B2



GLICK ENDO
Plugger/Spatula
Stopfer/Spatel
118/GL1

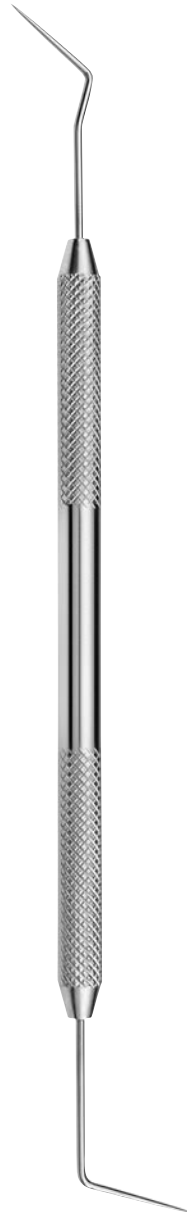

DG16
Spreader
Spreizer
101/16



Spreader
Spreizer
108/D11T

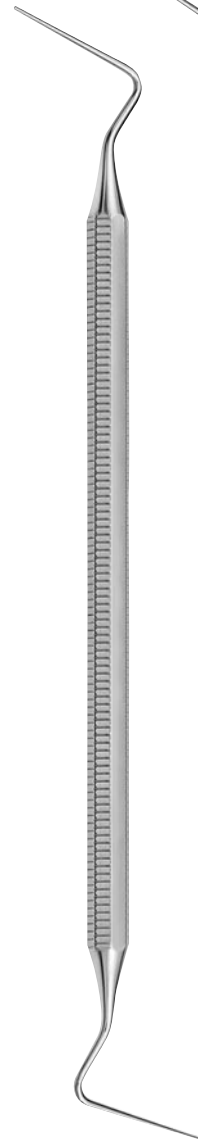

Plugger
Stopfer
108/1-3

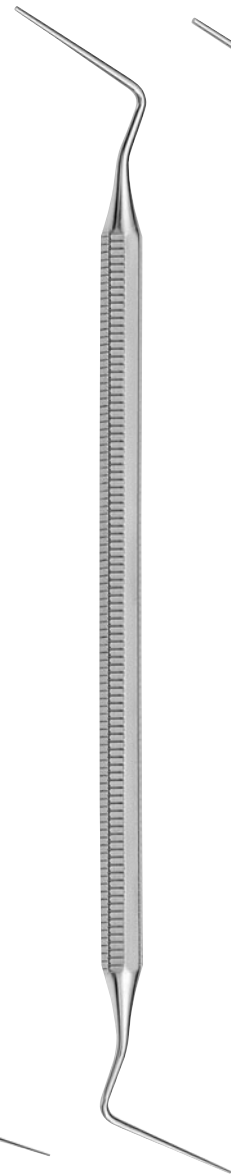

Plugger
Stopfer
108/5-7

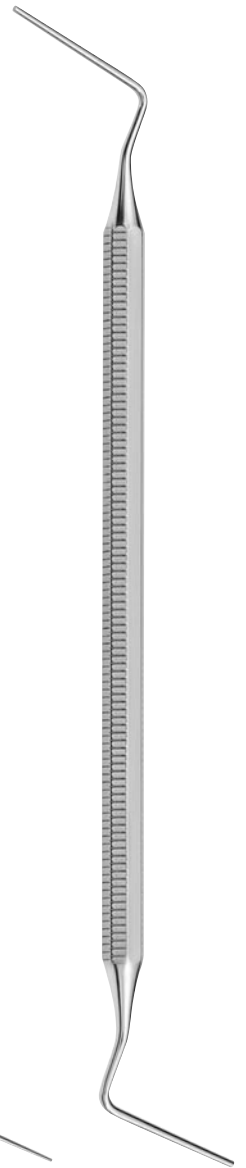

Plugger
Stopfer
108/9-11

ENDO BASIC SET



ENDO BASIC SET

101/16	Endontic explorer DG16	Endodontie Sonde DG16
200/51M	Mirror Handle with measuring scale	Spiegelgriff mit Meßskala
184/44	Endodontic tweezer	Endodontie Pinzette
134/31L	Endo Spoon (Excavator) #31L	Endo-Exkavator #31L
180/68	London College Tweezers with lock	London College Pinzette mit Schloß
134/GL2	Excavator GL2	Endo Exkavator GL2
108/D11T	Endo Spreader D11T	Endo Spreizer D11T
108/1-3	Root Canal Plugger 1-3	Wurzelkanalstopfer 1-3
108/5-7	Root Canal Plugger 5-7	Wurzelkanalstopfer 5-7
108/9-11	Root Canal Plugger 9-11	Wurzelkanalstopfer 9-11
610/4A	Stieglitz Root Splinter Forceps curved	Stieglitz Wurzelsplitterzange
242/3	Dean Gum Scissors 17cm serrated	Dean Zahnfleischschere 17cm gezahnt
500/3	Ergo Clip Wash Tray with Silicon Inserts 288 x 184 x 25mm	Wasch Tray mit Silikoneinsätzen 288 x 184 x 25mm

ENDO BASIS SET

PERIO SURGICAL SET



PERIO SURGICAL SET

185/8MK	Scalpel handle 13cm for mini blades
195/2	Suction Tube acidproof 3mm / 18cm
335/GF14ED	Goldman-Fox Raspatories GF14
183/2	Gillies Tissue Forceps 15cm
251/33	Micro-Scissors 15cm curved
174/55TC	Castroviejo Needle Holder 14cm TC straight
405/W	Williams Perio-Probe
400/5-6ED	Gracey Curette 5-6, lingual - buccal
400/7-8ED	Gracey Curette 7-8, lingual - buccal
400/11-12ED	Gracey Curette 11-12, mesial
400/13-14ED	Gracey Curette 13-14, distal
401/204S-ED	Universal Scaler 204S
101/23	Explorer e.e. Fig. 23
500/3	Wash Tray with Silicon Inserts 288 x 187 x 25mm

PARO CHIRURGIE SET

Skalpellgriff 13cm für Miniklingen
Saugkanüle 3mm / 18cm
Goldman-Fox Raspatorium GF14
Gillies chirurgische Pinzette 15cm
Mikroschere 15cm gebogen
Castroviejo Nadelhalter 14cm TC gerade
Williams Paro-Sonde
Gracey Kürette 5-6, lingual - bukkal
Gracey Kürette 7-8, lingual - bukkal
Gracey Kürette 11-12, mesial
Gracey Kürette 13-14, distal
Universal Scaler 204S
Sonde e.e. Fig. 23
Wasch Tray mit Silikoneinsätzen 288 x 187 x 25mm

PERIO CLASSIC SET



PERIO CLASSIC SET

PARO CLASSIC SET

400/5-6ED	Gracey Curette 5-6, lingual - buccal	Gracey Kürette 5-6, lingual - bukkal
400/7-8ED	Gracey Curette 7-8, lingual - buccal	Gracey Kürette 7-8, lingual - bukkal
400/11-12ED	Gracey Curette 11-12, mesial	Gracey Kürette 11-12, mesial
400/13-14ED	Gracey Curette 13-14, distal	Gracey Kürette 13-14, distal
200/51	Mirror Handle	Spiegelgriff
401/204SD-ED	Universal Scaler 204SD	Universal Scaler 204SD
401/H6-H7-ED	Universal Scaler H6-H7	Universal Scaler H6-H7
180/9	Meriam Tooth Tweezers	Meriam Zahnpinzette
405/CP15	Perio Probe CP15	Parosonde CP15
500/T	Wash Tray with Silicon Inlay 184 x 150 x 25mm	Wasch Tray mit Silikoneinsätzen 184 x 150 x 25mm

COLORident

Periodontal cures and scalers with ceramic color ring for better identification, biocompatible (handle 10m)
Parodontalküretten und Scaler mit Farbmarkierungsring aus Keramik für eine bessere Identifikation, biokompatibel (Griff 10mm)



COLORident GRACEY 1-2
lingual / buccal
404/1-2-ED ©



COLORident GRACEY 5-6
lingual / buccal
404/5-6-ED ©



COLORident GRACEY 11-12
mesial
404/11-12-ED ©



COLORident GRACEY 13-14
distal
404/13-14-ED ©



COLORident GRACEY 15-16
mesial
404/15-16-ED ©



COLORident GRACEY 1-2M
DEEP SCALE
lingual / buccal
404/1-2M-ED ©



COLORident GRACEY 5-6M
DEEP SCALE
lingual / buccal
404/5-6M-ED ©



COLORident GRACEY 7-8M
DEEP SCALE
lingual / buccal
404/7-8M-ED ©



COLORident GRACEY 11-12M
DEEP SCALE
lingual / buccal
404/11-12M-ED ©



COLORident GRACEY 13-14M
DEEP SCALE
lingual / buccal
404/13-14M-ED ©



COLORident M23
universal
404/M23-ED ©



COLORident Scaler 204SD
universal
404/204SD-ED ©

Hollow handle
Hohlgriff
Ø 8mm

ERGODESIGN
ERGODESIGN
Ø 8mm



ED = with ERGODESIGN Handle
ED = mit ERGODESIGN Griff



GRACEY 1-2
lingual / buccal
400/1-2 ○
400/1-2ED ●



GRACEY 3-4
lingual / buccal
400/3-4 ○
400/3-4ED ●



GRACEY 5-6
lingual / buccal
400/5-6 ○
400/5-6ED ●

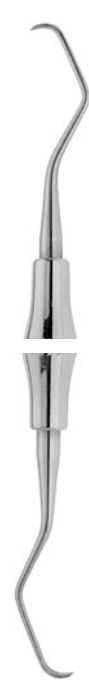

GRACEY 7-8
lingual / buccal
400/7-8 ○
400/7-8ED ●

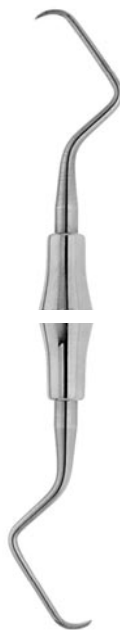

GRACEY 9-10
lingual / buccal
400/9-10 ○
400/9-10ED ●



GRACEY 11-12
mesial
400/11-12 ○
400/11-12ED ●



GRACEY 13-14
distal
400/13-14 ○
400/13-14ED ●



GRACEY 15-16
mesial
400/15-16 ○
400/15-16ED ●

DEEP SCALE GRACEYS

NEW: LEIBINGER Deep Scale Graceys, especially for the use in deep, narrow pockets and for root planing. On these special curettes, the 1st shaft is 3mm longer and the scaling tip is 50% shorter than regular Graceys.

DEEP SCALE GRACEYS

NEU: LEIBINGER Deep Scale Graceys sind besonders für den Einsatz in tiefen, engen Taschen und für die Wurzelglättung geeignet. Im Vergleich zu den Standard Graceys ist ihr 1er Schaft 3mm länger und gleichzeitig ist das Arbeitende um 50% verkürzt.



GRACEY 1-2M
lingual / buccal
400/1-2M-ED ©



GRACEY 5-6M
lingual / buccal
400/5-6M-ED ©



GRACEY 7-8M
lingual / buccal
400/7-8M-ED ©



GRACEY 11-12M
lingual / buccal
400/11-12M-ED ©

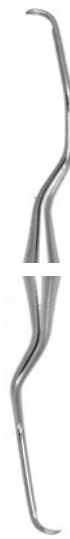

GRACEY 13-14M
lingual / buccal
400/13-14M-ED ©



Hollow handle
Hohlgriff
Ø 8mm

ERGODESIGN
ERGODESIGN
Ø 8mm



HYGIENIST H6-H7
Universal-Scaler
401/H6-H7 ○
401/H6-H7-ED ●



TOWNER U15-30
401/U15-30 ○



H5-33
401/H5-33 ○
401/H5-33-ED ●

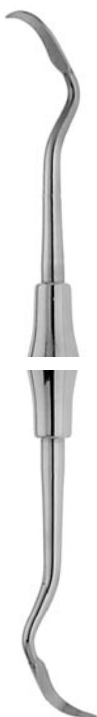

CI 2-3
401/CI03 ○



CK 6
401/CK6 ○
401/CK6-ED ●



TAYLOR 2-3
401/T2-3 ○

SICKLE SCALER SICHELSCALER

ED = ERGODESIGN Handle
ED = ERGODESIGN Griff



204
401/204-ED ☉



204 S
401/204S ○
401/204S-ED ☉



204 SD
401/204SD ○
401/204SD-ED ☉

» special stainless steel,
perfect grinding for
long lasting sharpness
» spezieller superharter Edelstahl,
perfekter Schliff für
langanhaltende Schärfe



COLUMBIA 2RL
401/2RL ○
401/2RL-ED ☉



COLUMBIA 4RL
401/4RL ○
401/4RL-ED ☉



COLUMBIA 13-14
401/C13-14 ○
401/C13-14-ED ☉

UNIVERSAL SCALER UNIVERSALSCALER

Hollow handle
Hohlgriff
Ø 8mm

ERGODESIGN
ERGODESIGN
Ø 8mm



LANGER 1-2
401/L1-2 ○
401/L1-2ED ●

LANGER 3-4
401/L3-4 ○
401/L3-4ED ●

LANGER 5-6
401/L5-6 ○
401/L5-6ED ●

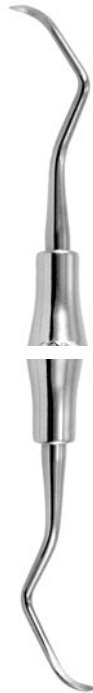

M23
401/M23 ○
401/M23-ED ●

MCCALL 13-14
401/13-14 ○

MCCALL 13S-14S
401/13S-14S ○

MCCALL 17S-18S
401/17S-18S ○



CUMMINE
121/C-ED

Reinwald Hook
Reinwald Hakchen



CUMMINE
121/C



MITCHEL
121/M

UNIVERSAL SCALER UNIVERSALSCALER

SHARPcut

- special hardness through special coating
- long lasting sharpness
- less wear out
- spezielle Hartstoffbeschichtung
- lang anhaltende Schärfe
- weniger Verschleiß



Universal-Scaler H6-H7

401/H6-H7-ED-TIN ©



Universal-Scaler 204SD

401/204SD-ED-TIN ©



Scaler M23

401/M23-ED-TIN ©



GRACEY 1-2M DEEP SCALE

lingual / buccal
400/1-2M-ED-TIN ©



GRACEY 5-6M DEEP SCALE

lingual / buccal
400/5-6M-ED-TIN ©



GRACEY 7-8M DEEP SCALE

lingual / buccal
400/7-8M-ED-TIN ©



GRACEY 11-12M DEEP SCALE

mesial
400/11-12M-ED-TIN ©



GRACEY 13-14M DEEP SCALE

distal
400/13-14M-ED-TIN ©



GRACEY 1-2
lingual / buccal

400/1-2ED-TIN ©



GRACEY 3-4
lingual / buccal

400/3-4ED-TIN ©



GRACEY 5-6
lingual / buccal

400/5-6ED-TIN ©



GRACEY 7-8
lingual / buccal

400/7-8ED-TIN ©



GRACEY 11-12
mesial

400/11-12ED-TIN ©



GRACEY 13-14
distal

400/13-14ED-TIN ©

ED = with ERGODESIGN Handle
ED = mit ERGODESIGN Griff



GOLDMAN-FOX 7
401/KGF7



GOLDMAN-FOX 8
401/KGF8



GOLDMAN-FOX 9
401/KGF9

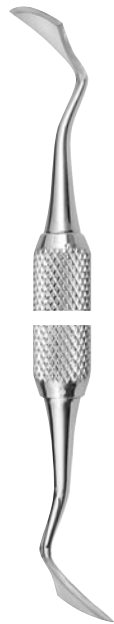

KIRKLAND 15/16
401/K1



ORBAN 1-2
401/KO12

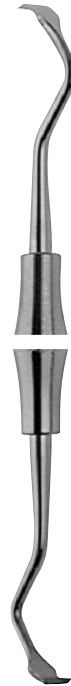

RHODES BACK-ACTION
401/RBA

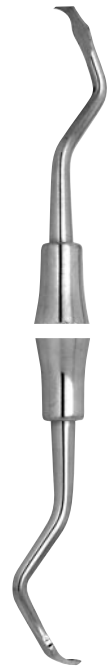

OCHSENBEIN
401/O4



HIRSCHFELD 3-7
401/H3-7



HIRSCHFELD 5-11
401/H5-11



SUGARMAN 1S-2S
401/FS12



SUGARMAN 3S-4S
401/FS34



SCHLUGER 9-10S
401/FS910



335/T1

335/T2

TUNNELING INSTRUMENTS TUNNELIERINSTRUMENTE

The tunneling instruments of Otto Leibinger Dental are designed for use in microsurgery for the preparation of split- and full-thickness flaps for subsequent ridge augmentations and for repairs of gingival defects caused by receding gums. The precisely manufactured working ends enable precise opening of the gingiva and can thus help prevent large flap openings.

Die Tunnelierinstrumente von Otto Leibinger Dental sind gefertigt für den Einsatz in der Mikrochirurgie zur Präparation von Spalt- und Vollflappen für spätere Kammaufbauten sowie zum Aufbau der Gingiva im Falle von Rezessionen. Die fein gearbeiteten Arbeitsenden erlauben eine präzise Eröffnung der Gingiva und somit können große Aufklappungen vermieden werden.

Hollow handle
Hohlgriff
Ø 8mm

ERGODESIGN
ERGODESIGN
Ø 8mm



MOLT 9
335/M9 ○
335/M9-ED ●



GLICKMANN 24GSP
335/24GSP ○
335/24GSP-ED ●



BUSER
335/B1 ○
335/B1-ED ●



GOLDMAN FOX 14
335/GF14 ○
335/GF14-ED ●



MOLT 10
335/M10-ED ●



PRICHARD PR3S
335/PR3S ○

TITANIUM TITAN

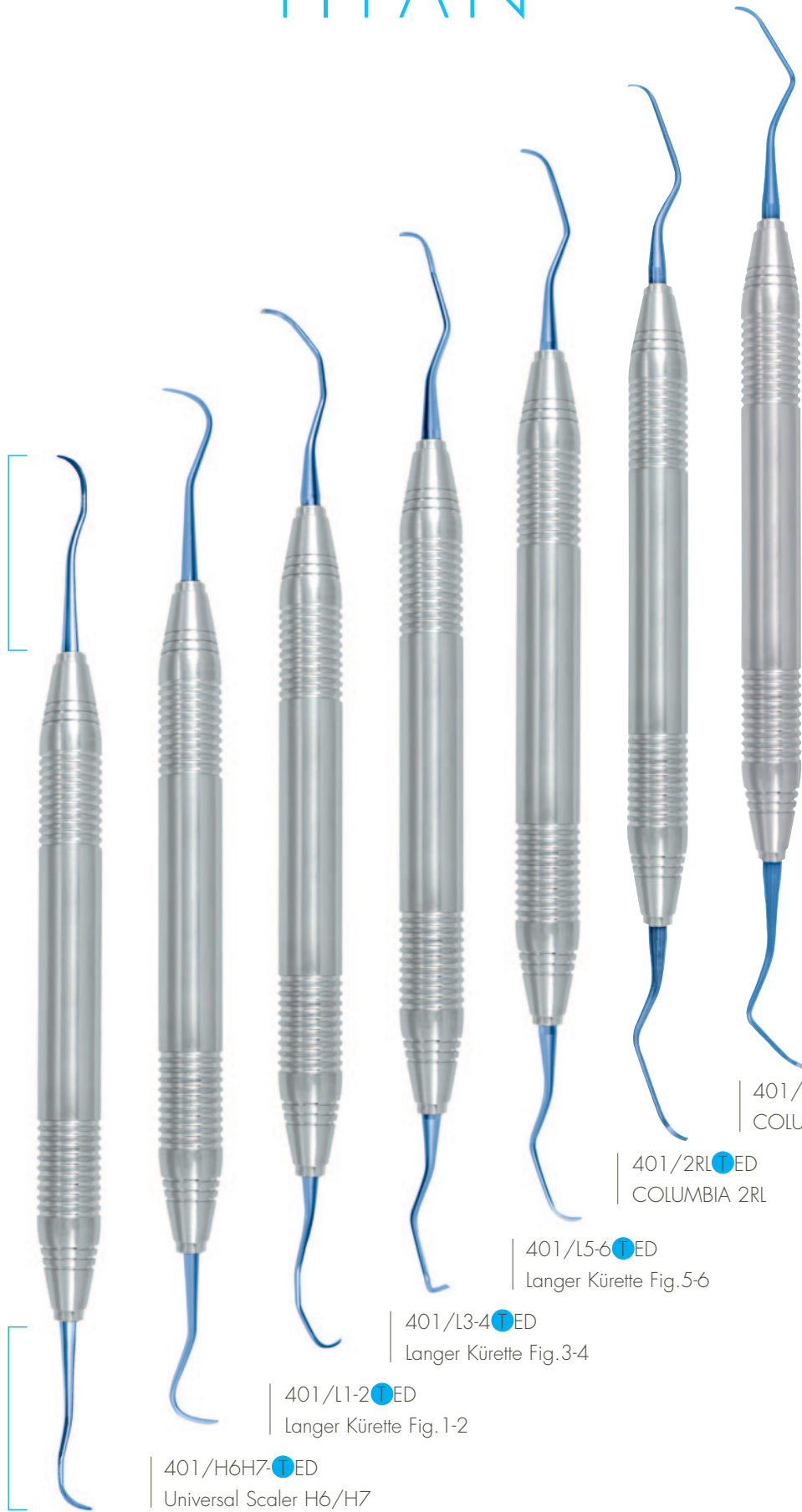

401/204SD-ED
Universal Scaler 204SD

401/H6H7-ED
Universal Scaler H6/H7

401/L1-2-ED
Langer Kürette Fig. 1-2

401/L3-4-ED
Langer Kürette Fig. 3-4

401/L5-6-ED
Langer Kürette Fig. 5-6

401/2RL-ED
COLUMBIA 2RL

401/4RL-ED
COLUMBIA 4RL

ERGODESIGN Titanium Currettes with extremely light handle and tips made of Titanium especially applicable to clean implants. By using Titanium for the tips, a damage of the surface of the implants will be avoided. The L-Light Titanium Currettes are currently available in 7 different pattern.

ERGODESIGN Titan Küretten mit federleichtem Griff und Arbeitenden aus Titan, ideal für die Reinigung von Implantaten. Durch die Verwendung von Titan für die Spitzen wird eine Beschädigung der Implantatoberfläche vermieden. Die L-Light Titan Küretten sind in 7 verschiedenen Ausführungen erhältlich.

OTTO LEIBINGER EXTRACTING FORCEPS ZAHNZANGEN

- DELICATE PATTERN
- SQUARE PROFILE FOR A SAFE GRIP
- SMOOTH AND EVEN OPENING AND CLOSING
- STANDARD HANDLE FULLY SERRATED
- ERGODESIGN HANDLE SMOOTH FOR EASY CLEANING

Selected forceps are also available as PREMIUM pattern in superior quality.

- FEINE GRAZILE FORM
- HAFTPROFIL FÜR SICHEREN HALT
- GLEICHMÄSSIGER, LEICHTER GANG
- STANDARD-GRIFF VOLLKARIERT
- ERGODESIGN-GRIFF GLATT ZUR EINFACHEN REINIGUNG

Ausgewählte Zangen erhalten Sie auch in der PREMIUM-Qualität. Diese zeichnet sich durch besonders hochwertige Verarbeitung aus.

NEW ERGODESIGN





P600/...
600/...

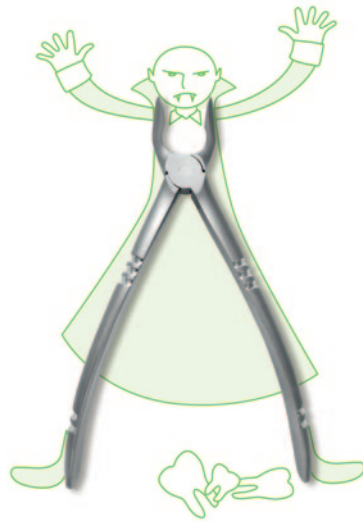

604/...

NEW



FIG. 2
upper incisors
and canines
obere Schneide-
und Eckzähne
P600/2 PREMIUM
600/2
604/2 ERGODESIGN



FIG. 1
upper incisors and
canines, wide
obere Schneide- und
Eckzähne, breit
P600/1 PREMIUM
600/1

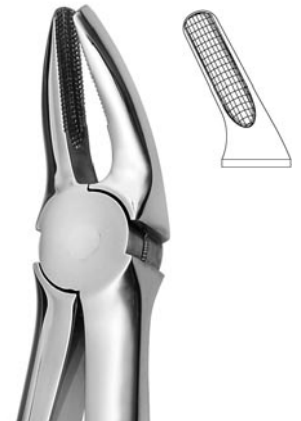

FIG. 7
upper bicuspid
obere Prämolaren
P600/7 PREMIUM
600/7
604/7 ERGODESIGN

NEW



FIG. 17
upper molars, right side
obere Molaren, rechts
P600/17 PREMIUM
600/17

NEW 604/17 ERGODESIGN



FIG. 18
upper molars, left side
obere Molaren, links
P600/18 PREMIUM
600/18

NEW 604/18 ERGODESIGN



FIG. 89
upper molars, right,
gripping in depth
obere Molaren,
rechts, tiefgreifend
P600/89 PREMIUM
600/89

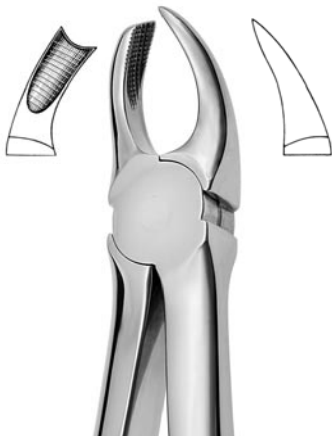

FIG. 90
upper molars, left,
gripping in depth
obere Molaren, links,
tiefgreifend
P600/90 PREMIUM
600/90



FIG. 67
upper wisdom teeth, narrow
obere Weisheitszähne, schmal

600/67
NEW 604/67 ERGODESIGN



FIG. 67A
upper wisdom teeth,
wide
obere Weisheitszähne,
breit
P600/67A PREMIUM
600/67A



FIG. 29
upper front roots
obere Frontzahnwurzeln
P600/29 PREMIUM
600/29
NEW 604/29 ERGODESIGN



FIG. 30
upper roots
obere Wurzeln
P600/30 PREMIUM
600/30



FIG. 51
upper roots, short and
narrow beaks
obere Wurzeln, kurzes,
schmales Maul
P600/51 PREMIUM
600/51



FIG. 51A
upper front roots,
narrow beaks
obere Wurzeln,
schmales Maul
P600/51A PREMIUM
600/51A
NEW 604/51A ERGODESIGN



FIG. 76
upper roots
obere
Wurzeln
600/76

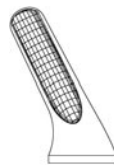

upper roots,
narrow
obere
Wurzeln,
schmal
600/76N





P600/...
600/...
604/... **ERGODESIGN**



FIG. 4
lower canines
untere Schneidezähne
P600/4 PREMIUM
600/4

NEW 604/4 **ERGODESIGN**



FIG. 13
lower canines and bicuspid
untere Eckzähne und Prämolaren
P600/13 PREMIUM
600/13

NEW 604/13 **ERGODESIGN**



FIG. 22
lower molars, either side
untere Molaren, beide Seiten
P600/22 PREMIUM
600/22

NEW 604/22 **ERGODESIGN**

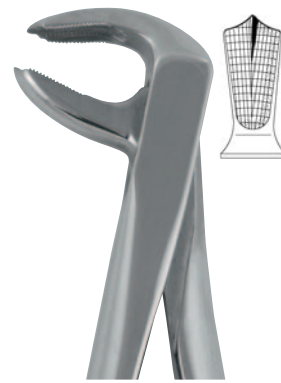

FIG. 73
lower molars
untere Molaren
P600/73 PREMIUM
600/73



FIG. 75
lower canines and bicuspid
untere Eckzähne und Prämolaren
P600/75 PREMIUM
600/75



FIG. 33
lower roots
untere Wurzeln
P600/33 PREMIUM
600/33

NEW 604/33 **ERGODESIGN**



FIG. 33A
lower roots, with narrow beaks
untere Wurzeln, mit schmalen Maul
P600/33A PREMIUM
600/33A



FIG. 86A
lower molars, gripping in depth, lateral
untere Molaren, tiefgreifend, von lateral
P600/86A PREMIUM
600/86A
NEW 604/86A ERGODESIGN



FIG. 86C
lower molars, gripping in depth, lateral
untere Molaren, tiefgreifend,
von lateral
600/86C



FIG. 79
lower wisdom teeth
untere Weisheitszähne
P600/79 PREMIUM
600/79
NEW 604/79 ERGODESIGN

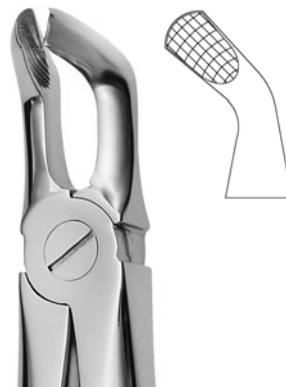

FIG. 79A
lower wisdom teeth
untere Weisheitszähne
600/79A

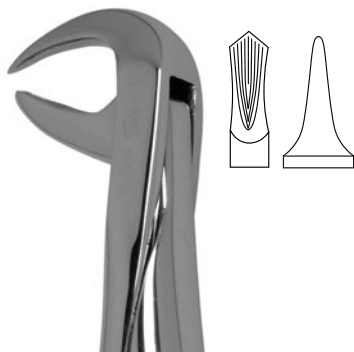

FIG. 99
lower molars
untere Molaren
600/99

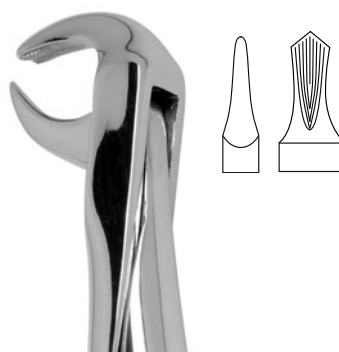

FIG. 99 1/4
lower molars
untere Molaren
600/99-1-4



FIG.34
upper incisors and canines,
gripping depth
obere Schneidezähne und Eckzähne,
Spez.-Maul, tiefgreifend
600/34

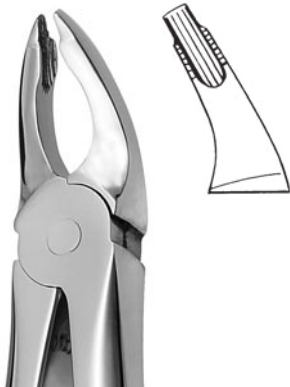

FIG.35
upper premolars,
gripping depth
obere Prämolaren,
Spez.-Maul, tiefgreifend
600/35



FIG.36
lower roots, gripping depth
untere Wurzeln, Spez.-Maul, tief-
greifend
600/36



FIG.74
lower roots, wide beaks
untere Wurzeln, Maul
P600/74 PREMIUM
600/74



FIG.46L
very fine lower roots,
gripping depth
sehr feine untere Wurzeln,
tiefgreifend
P600/46L PREMIUM
600/46L



FIG.74N
lower roots
and crowded incisors,
narrow beaks
untere Wurzeln
und engstehende Schneidezähne
P600/74N PREMIUM
600/74N
NEW 604/74N ERGODESIGN



600/...

604/... **ERGODESIGN**

FOR CHILDREN
FÜR KINDER



FIG. 37

upper incisors
obere Schneidezähne
600/37

NEW 604/37 ERGODESIGN



FIG. 39

upper molars, either side, wide
obere Molaren, beide Seiten, breit
600/39

NEW 604/39 ERGODESIGN



FIG. 39L

upper molars, left
obere Molaren, links
600/39L



FIG. 39R

upper molars, right
obere Molaren, rechts
600/39R



FIG. 51S

upper roots
obere Wurzeln

600/51S
NEW 604/51S ERGODESIGN



FIG. 29S

upper incisors and roots, either side
obere Schneidezähne und Wurzeln,
beide Seiten
600/29S

NEW 604/29S ERGODESIGN



FIG.13S
lower incisors and bicuspid
untere Schneidezähne und Prämolaren
600/13S

NEW 604/13S ERGODESIGN



FIG.22S
lower molars
untere Molaren
600/22S

NEW 604/22S ERGODESIGN



FIG.33S
lower roots
untere Wurzeln
600/33S

NEW 604/33S ERGODESIGN

SET OF EXTRACTING FORCEPS FOR CHILDREN ZAHNZANGEN SET FÜR KINDER

Set of Extracting Forceps for children (7 pcs)
Zahnzangen Set für Kinder (7 Zangen)

FIG.37 upper incisors
obere Schneidezähne

FIG.39 upper molars, either side
obere Molaren, beide Seiten

FIG.51S upper roots
obere Wurzeln

FIG.29S upper incisors and roots, either side
obere Schneidezähne und Wurzeln, beide Seiten

FIG.13S lower incisors and bicuspid
untere Schneidezähne und Prämolaren

FIG.22S lower molars, either side
untere Molaren, beide Seiten

FIG.33S lower roots
untere Wurzeln

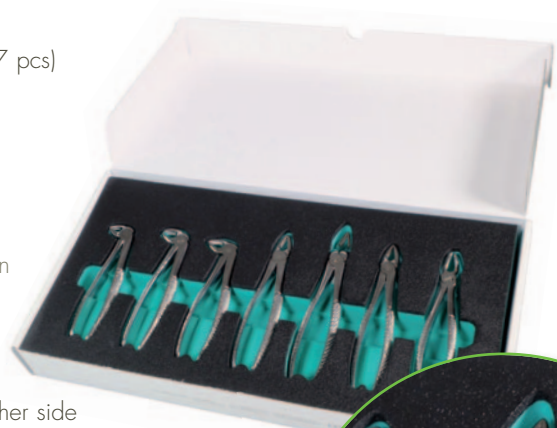

600/PEDO-SET

- » also available with ERGODESIGN Handle
- » auch im ERGODESIGN erhältlich

NEW 604/PEDO-SET-ED

FOR CHILDREN
FÜR KINDER



FIG. 3
upper molars
obere Molaren
605/3

KLEIN



FIG. 137
upper incisors
obere Schneidezähne
605/137



FIG. 139
upper milk molars
obere Milchmolaren
605/139



FIG. 51S
upper roots
obere Wurzeln
605/51S



FIG. 5
lower incisors
untere Schneidezähne
605/5



FIG. 6
lower molars
untere Molaren
605/6



FIG. 7
lower roots
untere Wurzeln
605/7

SET OF EXTRACTING FORCEPS (INCLUDING 10 FORCEPS) ZAHNZANGEN EXTRAKTIONS-SET (BESTEHEND AUS 10 ZANGEN)

P600/SET	PREMIUM Set
600/SET	STANDARD Set
NEW 604/ED-SET	ERGODESIGN Set

- FIG.2 upper incisors and canines
obere Schneide- und Eckzähne
- FIG.7 upper bicuspid
obere Prämolaren
- FIG.17 upper molars, right side
obere Molaren, rechts
- FIG.18 upper molars, left side
obere Molaren, links
- FIG.67A upper wisdom teeth, wide
obere Weisheitszähne, breit
- FIG.51A upper front roots, narrow beaks
obere Wurzeln, schmal
- FIG.13 lower canines and bicuspid
untere Eckzähne und Prämolaren
- FIG.22 lower molars, either side
untere Molaren beide Seiten
- FIG.33 lower roots
untere Wurzeln
- FIG.79 lower wisdom teeth
untere Weisheitszähne



ANATOMICALLY SHAPED
FINE WORKING TIPS
ANATOMISCH GEFORMTE,
SCHMALE ARBEITSENDEN

NEW 603/... ERGODESIGN



FIG.2
upper incisors
and canines
obere Schneide-
und Eckzähne
603/2



FIG.7
upper bicuspsids
obere Prämolaren
603/7

DEEP GRIPPING TIEFGREIFEND



FIG.34
upper incisors and canines,
gripping depth
obere Schneidezähne und Eckzähne,
Spez.-Maul
603/34



FIG.35
upper premolars,
gripping depth
obere Prämolaren,
Spez.-Maul
603/35



FIG.67
upper wisdom teeth, narrow
obere Weisheitszähne, schmal
603/67



FIG.79
lower wisdom teeth
untere Weisheitszähne
603/79



FIG.13
lower canines and bicuspid
untere Eckzähne und Prämolaren
603/13



FIG.33
lower roots
untere Wurzeln
603/33



FIG.36
lower roots,
gripping depth
untere Wurzeln,
Spez.-Maul,
603/36



FIG.74N
lower roots and crowded incisors,
narrow beaks
untere Wurzeln
und engstehende Schneidezähne
603/74N

D = diamond coated

D = diamantiert



Upper and
third molars
Obere und
dritte Molaren

602/10S
602/10SD



Upper molars, left side,
gripping in depth
Obere Molaren, links,
tiefgreifend

602/88L



Upper molars, right side,
gripping in depth
Obere Molaren, rechts,
tiefgreifend

602/88R



Upper incisors, canines,
bicuspid and roots
Obere Schneidezähne,
Eckzähne, Prämolaren
und Wurzeln
18cm
602/150
602/150D 



Lower molars
Untere
Molaren
602/17
602/17D 



Lower molars,
either side
Untere Molaren,
beide Seiten
602/23
602/23D 



Lower incisors, canines,
bicuspid and roots
Untere Schneide- und
Eckzähne, Prämolaren
und Wurzeln
602/151
602/151D 

FOR CHILDREN FÜR KINDER



Upper incisors, canines and
bicuspids
Obere Schneidezähne,
Eckzähne und Prämolaren
15cm
602/150S



Lower incisors, canines,
bicuspids and molars
Untere Schneide- und Eckzähne,
Prämolaren und Molaren
15cm
602/151S



WITZEL
610/1



Root Splinter Forceps
Wurzelfragmentzange
610/5

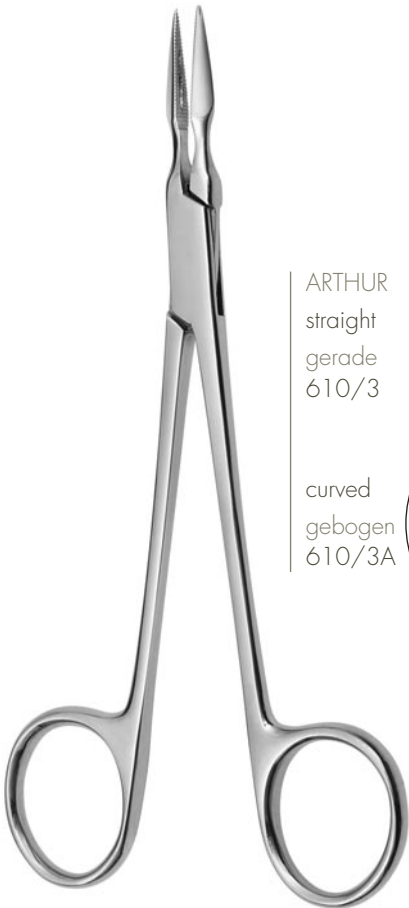

ARTHUR
straight
gerade
610/3

curved
gebogen
610/3A

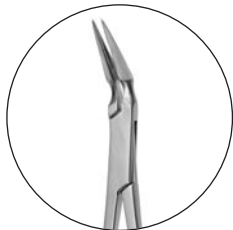

STIEGLITZ
straight
gerade
610/4

curved
gebogen
610/4A

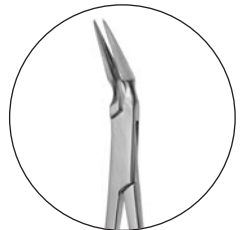



BEIN

2mm



| 190/1

3mm



| 190/2

4mm



| 190/3

3mm



| straight
gerade
190/4

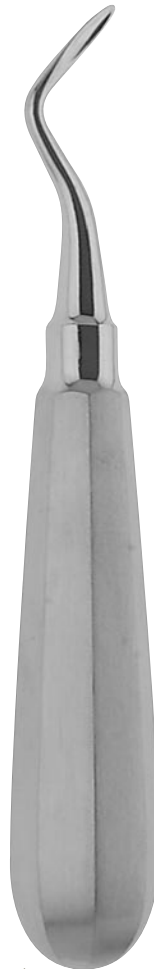

| 190/6



| 190/7

FLOHR

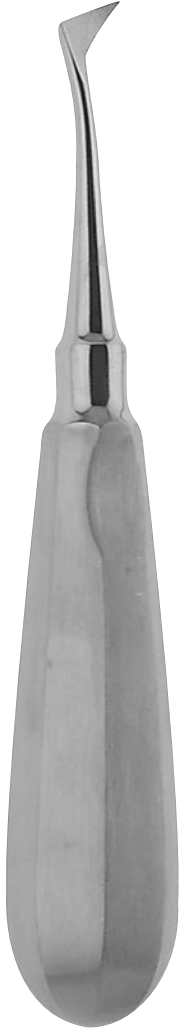

CRYER
190/13



CRYER
190/14



BARRY
190/B50



BARRY
190/B51

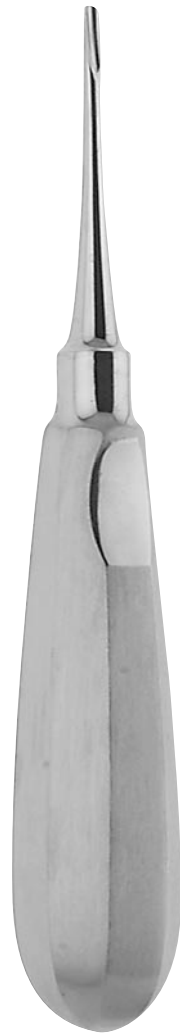

APICAL 1
193/301



APICAL 2
193/302



APICAL 3
193/303

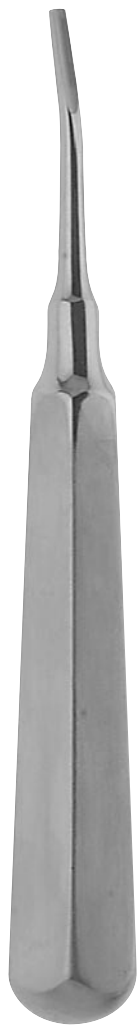

COUPLAND



FIG.1
190/15



FIG.2
190/16



FIG.3
190/17



WARWICK JAMES

192/1

192/2

192/3



HYLIN



4 mm
190/31



3 mm
190/32



190/33



190/34

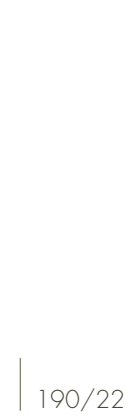

3mm

190/22



3,5mm

190/23



4mm

190/24

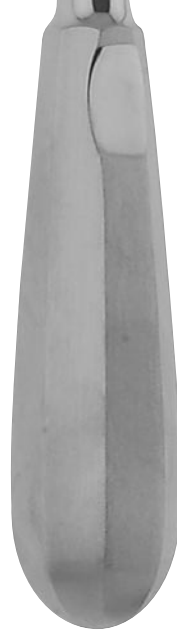

LINDO LEVIAN

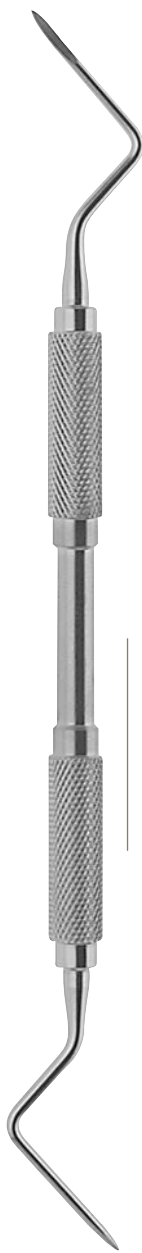

192/01

192/02

192/03

HEIDBRINK
Root Apex Elevator
Wurzelrestentferner



192/04

192/05

192/06

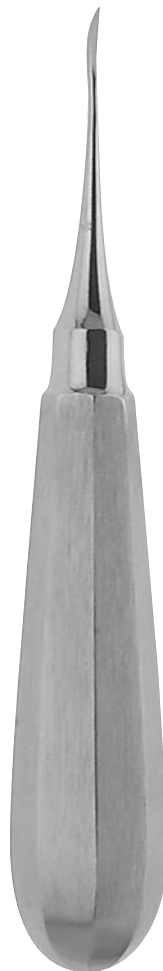

192/11

192/12

192/13

HEIDBRINK
Root Tip Pick
Wurzelspitzenheber



WHAT YOU SHOULD KNOW:

Most dental instruments are made of corrosion-resistant high-grade steels. The requirements for the different grades of steel are defined in national and international standards. They are adapted to meet the special functional properties and conditions of use. Good elasticity, high tensile strength and good corrosion resistance are required for non-cutting instruments such as tooth extracting forceps or tweezers. Cutting instruments such as scissors or scalpels mainly require a high degree of hardness and resistance to wear and corrosion. If users are asked what they understand by the terms "stainless steel" or "corrosion-resistant high-grade steel", they often assume that so-called stainless steel materials are physically indestructible materials that have high chemical resistance. Many users are surprised to hear or find out that even stainless steel can be susceptible to various types of mechanical, thermal or chemical attack. The corrosion-resistance of stainless steel materials is based on their alloy structure, which forms passivated surface layers that in turn protect the steel. However, external influences can destroy these protective layers and cause severe damage to the instruments. It is therefore extremely important to preserve the passivated layers on the instruments by appropriate reprocessing methods.

More details and instructions for the correct instrument processing can be found in the brochure "Instrument Processing properly done in Dental Practice" as free download from www.a-k-i.org.

WAS SIE WISSEN SOLLTEN:

Die meisten zahnärztlichen Instrumente werden aus korrosionsbeständigen Edelstählen gefertigt. Die Anforderungen an die verschiedenen Stahlsorten sind in nationalen und internationalen Normen festgelegt und auf die besonderen funktionellen Eigenschaften und Einsatzbedingungen abgestimmt. Für nicht schneidende Instrumente, beispielsweise Zahnzangen oder Pinzetten, werden gute Elastizität, Zähigkeit und hohe Korrosionsbeständigkeit gefordert. Schneidende Instrumente wie Zahnreiniger, Scheren oder Messer verlangen vor allem hohe Härte sowie Beständigkeit gegen Verschleiß und Korrosion. Fragt man nach der Bedeutung von Begriffen wie Edelstahl, nicht rostender Stahl, stainless steel, so wird häufig vermutet, dass Edelstahl ein unverwüstliches, äußerst beständiges Material sei. Zahlreiche Benutzer sind überrascht, wenn sie erfahren oder selbst feststellen müssen, dass auch Edelstahl durchaus gegen die vielfältigen Angriffe mechanischer, thermischer oder chemischer Art anfällig sein kann. Die Korrosionsbeständigkeit der Edelstähle beruht darauf, dass sie aufgrund ihrer Legierung so genannte Passivschichten an der Oberfläche bilden, die den Stahl schützen. Durch äußere Einflüsse können diese Schutzschichten jedoch zerstört werden, und es entstehen dann Schäden an den Instrumenten. Es ist deshalb außerordentlich wichtig, durch sachkundige Aufbereitung die Passivschichten der Instrumente zu erhalten.

Detaillierte und umfangreiche Informationen zur Instrumentenaufbereitung erhalten Sie in der aktuellen Broschüre „Instrumentenaufbereitung in der Zahnarztpraxis richtig gemacht“, als kostenloser Download auf www.a-k-i.org.

LUXATORS LUXATOREN



3 mm	190/L1ST-ED	190/L1C-ED	190/3ST-ED	190/3C-ED
4 mm	190/L2ST-ED	190/L2C-ED	190/4ST-ED	190/4C-ED
4,5 mm			190/45ST-ED	190/45C-ED

The LEIBINGER ERGODESIGN Luxators are used for severing the delicate fibres connecting the tooth root with the jaw bone (ligaments) and extending the tooth socket (alveolus) thus releasing the tooth from the bone and allowing it to be removed easily. This allows the tooth to be extracted gently, which is ideal preparation for implantation.

Mit den LEIBINGER ERGODESIGN Luxatoren können die feinen Fasern, die die Zahnwurzel mit dem Kieferknochen verbinden (Ligamente) durchtrennt und das Zahnfach (Alveole) aufgeweitet werden, so dass der Zahn die Verbindung zum Knochen verliert und leicht entfernt werden kann. Somit erhalten Sie eine schonende Extraktion, ideal für die Vorbereitung einer Implantation.

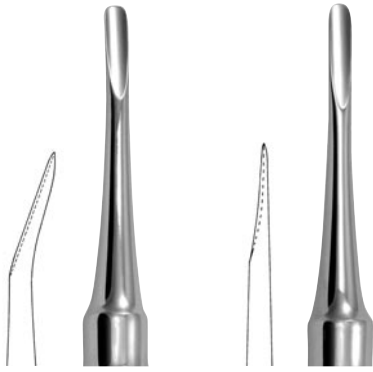
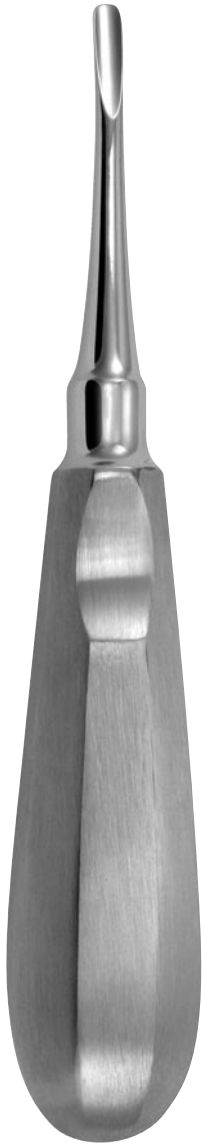

NEW	2,5mm	190/25C	190/25ST
	3 mm	190/3C	190/3ST
	4 mm	190/4C	190/4ST
	5 mm	190/5C	190/5ST

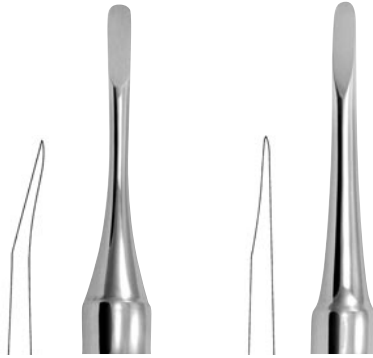

	3 mm	190/3CF	190/3STF
	4 mm	190/4CF	190/4STF
	5 mm	190/5CF	190/5STF

LUXATORS LUXATOREN



BARRY | FIG.320
191/320

FIG.321
191/321



WINTER | FIG.11L
191/11L

FIG.11R
191/11R

FIG.14L
191/14L

FIG.14R
191/14R

CARTRIDGE SYRINGE ZYLINDER AMPULLEN SPRITZE



WITH ASPIRATION DEVICE
MIT PFEILASPIRATION

metric thread 1,8 ml
metrisches Gewinde 1,8ml
370/18M

US thread 1,8cc
US-Gewinde 1,8cc
370/18US

metric thread 2,2ml
metrisches Gewinde 2,2ml
370/22M

US thread 2,2cc
US-Gewinde 2,2cc
370/22US



WITHOUT ASPIRATION DEVICE
OHNE ASPIRATION

metric thread 1,8ml
metrisches Gewinde 1,8ml
371/18M

US thread 1,8cc
US-Gewinde 1,8cc
371/18US

metric thread 2,2ml
metrisches Gewinde 2,2ml
371/22M

US thread 2,2cc
US-Gewinde 2,2cc
371/22US



AUSTIN
353/7



WIEDER
14cm
354/W1

14,5cm
354/W2



FARABEU

Set with 2 pieces
Set mit 2 Stück

125mm
353/8

150mm
353/9



CAWOOD MINNESOTA
354/6



TUFFIER
Tongue Retractor malleable
Zungenspatel biegsam
200mm
354/7



BRUENINGS
Tongue Retractor
Zungenspatel
190mm
354/8



BRAANEMARK
 Vestibulum Retractor
 Vestibulum-Haken
 700/2 A=80mm
 for children
 für Kinder
 700/2K A=75mm



Vestibulum and
 Cheek Retractor
 Vestibulum und
 Wangenabhalter
 700/6 A=80mm



STERNBERG
 Lip Retractor
 Lippenhalter
 14cm
 700/3



MOLT
 12cm
 700/7
 14cm
 700/8



MIDDELDORPF

14x17 mm, [21,5 cm
353/1

20x22 mm, [22 cm
353/2

26x30 mm, [23,5 cm
353/3



OBWEGESER

72x11 mm, [22 cm
353/5

KOCHER-LANGENBECK

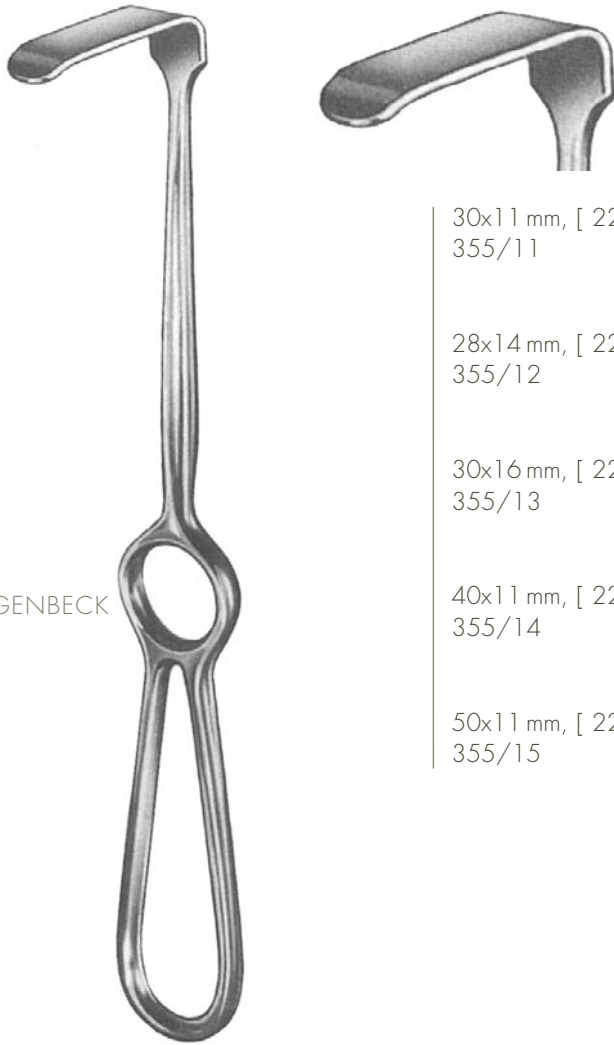

30x11 mm, [22 cm
355/11

28x14 mm, [22 cm
355/12

30x16 mm, [22 cm
355/13

40x11 mm, [22 cm
355/14

50x11 mm, [22 cm
355/15

OBWEGESER



Mandibular Chanel Retractor

Progeniehaken
8 mm, [175 mm
353/20

10 mm, [175 mm
353/21

BOWDLER HENRY
[19cm
353/12



lead filled head
mit Bleifüllung
Ø 22mm / 140g

[16,5cm
330/1



with interchangeable
plastic disks
mit auswechselbaren
Kunststoffbacken
Ø 25mm / 140g

[18cm
330/3



Hollow handle
Hohlgriff
Ø 8mm

ERGODESIGN
ERGODESIGN
Ø 8mm



MOLT 9
335/M9 ○
335/M9-ED ●



GLICKMANN 24GSP
335/24GSP ○
335/24GSP-ED ●



BUSER
335/B1 ○
335/B1-ED ●



GOLDMAN FOX 14
335/GF14 ○
335/GF14-ED ●



MOLT 10
335/M10-ED ●



PRICHARD PR3S
335/PR3S ○

WILLIGER
160x6 mm
335/06



OBWEGESER
[17,5 cm
6 mm
337/71



7 mm
337/72

9 mm
337/73

11 mm
337/74

SELDIN S23
[19,5 cm
335/S23



HOWARTH
[21,5 cm
335/H



WILLIGER
[16,5 cm
337/1



sharp scharf

blunt stumpf



FREER
[18,5 cm
336/5

Octagonal handle
Achtkant-Griff
Ø 5,5mm

ERGODESIGN
ERGODESIGN
Ø 8mm



BONE FILES KNOCHENFEILEN



MILLER
338/3



MILLER
338/4



MILLER
338/5



OCHSENBEIN 1
332/41



OCHSENBEIN 2
332/42

SHARP SPOONS SCHARFE LÖFFEL



HEMINGWAY
[18 cm
2,5 mm | 3,0 mm | 3,5 mm
130/1 | 130/2 | 130/3



LUKAS
[18 cm
FIG. 1
2,5 mm
336/11 ●
336/11-ED ◎

FIG. 2
3,0 mm
336/22 ●
336/22-ED ◎



[16 cm
185/5

| 185/5ED

[16 cm
185/6

| 185/6ED

- » Scalpel blades on special request available
- » Skalpellklingen auf Anfrage erhältlich



Micro Blade Holder
for Mini Blades
Mikro Skalpellklingenhalter
für Mini-Klingen
[13 cm
185/8MK



FIG. 3
[12,5cm
185/3



- » stainless steel
- » acid proof
- » rostfreier Stahl
- » säurebeständig



FRAZIER
Suction Tube Saugkanüle
[19 cm

Ø 2,0 mm
195/F2-6

Ø 3,0 mm
195/F3-9

Ø 4,0 mm
195/F4-12

[14 cm

Ø 3,0 mm
195/02

[19 cm

Ø 1,5 mm
195/1

Ø 3,0 mm
195/2

Ø 5,0 mm
195/3

 with notch
mit Einkerbung

[14 cm

Ø 3,0 mm
195/05

[19 cm

Ø 1,5 mm
195/4

Ø 3,0 mm
195/5

Ø 5,0 mm
195/6



	STANDARD	SCHMAL	FEIN
[13cm	182/12	182/22	182/32
[14,5cm	182/13	182/23	182/33
[16cm	182/14	182/24	



	SEMKEN straight gerade	curved gebogen
[12cm	182/51	182/53
[15cm	182/52	182/54

POTTS-SMITH

[18cm	182/41
--------	--------





[12cm
[15cm

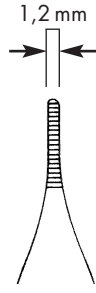

ADSON
182/61
182/62

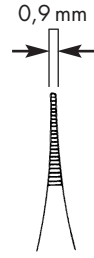

MICRO ADSON
182/63



McINDOE
[15cm
182/1



STANDARD

[13cm
[14,5cm
[16cm

183/12
183/13
183/14



SCHMAL

183/22
183/23
183/24



FEIN

183/32
183/33



SEMKEN

straight

gerade

[12cm
[15cm

183/51
183/52



curved

gebogen

183/53
183/54



POTTS-SMITH

[18cm
183/41





GILLIES
[15 cm
183/2



[12 cm
[15 cm

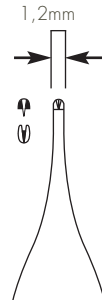

ADSON
183/61
183/62



MICRO ADSON
183/63
183/64

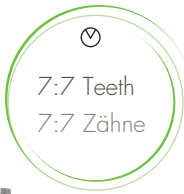

ADSON BROWN
[12cm
183/66



Forceps
with tying plate
Pinzette
mit Fadenplatte
[150mm
184/20

[180mm
184/21



1x2 Z
[150mm
184/24

[180mm
184/25



IRIS
[11 cm

straight
gerade
240/1
240/1 **SC**



curved
gebogen
240/2
240/2 **SC**



GOLDMAN-FOX
[13 cm
serrated
gezahnt

straight
gerade
250/1
250/1 **SC**



curved
gebogen
250/0
250/0 **SC**



KELLY
[16 cm

straight
gerade
220/2
220/2 **SC**



curved
gebogen
220/1
220/1 **SC**



LaGRANGE
[11,5 cm

245/1
245/1 **SC**



SC = SUPERCUT

very sharp edges through special grinding
one ring gold

extrem scharf durch Spezialschliff
ein Ring vergoldet



delicate
fein
[14,5 cm

straight
gerade
217/4



curved
gebogen
218/4

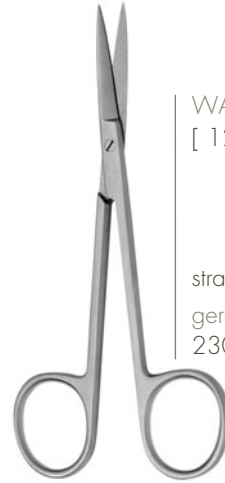

WAGNER
[12 cm

straight
gerade
230/1



curved
gebogen
230/2



JOSEPH
[14,5 cm

straight
gerade
235/3



curved
gebogen
235/4



SPENCER
[9 cm
250/20

[10,5 cm
250/21

[12,5 cm
250/22



Micro
Mikro



Scissors
straight
Schere
gerade
[150mm
251/31

[180mm
251/32

curved
gebogen
[150mm
251/33

[180mm
251/34

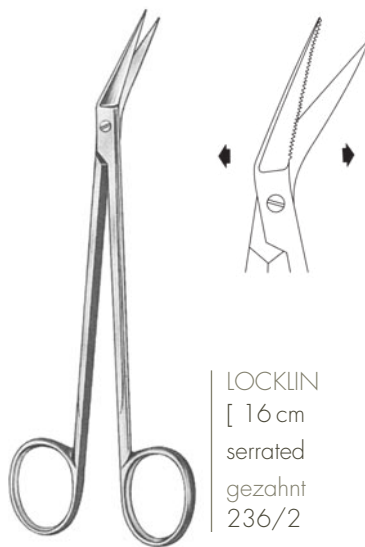

LOCKLIN
[16 cm
serrated
gezahnt
236/2



DEAN
[17 cm
serrated
gezahnt
242/3



METZENBAUM
straight
gerade

[14 cm
229/1

[18 cm
229/3



METZENBAUM
curved
gebogen

[14 cm
229/2

[18 cm
229/4



BEEBEE
straight
gerade

[10,5 cm
210/1



BEEBEE
curved
gebogen

[10,5 cm
210/2



UNIVERSAL
[12cm
Wire Scissors
Folien-/Draht- & Bleischere
250/5
250/5 **TC**

HI TECH ÖL HI TECH OIL

HI TECH OIL – sterilizable

Lubricant for dental
and surgical instruments

- Validated for autoclave and heat sterilization
- Heat resistant up to 260°C
- Excellent protection against corrosion and oxidation
- Odorless, transparent and silicone free
- No staining and crusting on instruments
- Application tip 7mm
- Contains 12ml

HI TECH ÖL – sterilisierbar

Zur Pflege von Dental-
und Chirurgie-Instrumenten

- Validiert für Autoklav und Heißluftsterilisation
- Temperaturstabil bis 260°C
- Ausgezeichneter Korrosions- und Oxidationsschutz für Ihre Instrumente
- Geruchlos, transparent und silikonfrei
- Keine Fleckenbildung und kein Verharzen auf den Instrumenten
- Inhalt 12ml



with 7mm application tip
mit 7mm Applikationsnadel
900/HTO7



CASTROVIEJO
[14 cm
straight
gerade
174/55 TC



curved
gebogen
174/57 TC



5/0 - 7/0

BARRAQUER
[18 cm
straight
gerade
174/66 TC



6/0 - 8/0

MICRO-
CASTROVIEJO
[14 cm
straight
gerade
174/59 TC



curved
gebogen
174/60 TC



5/0 - 7/0

INSTRUMENTS WITH TC INSERTS

To increase strength and hardness TC inserts are being welded into the working tips of our needle holders. By using this special material during tempering, a high HRC can be obtained which allows to achieve a perfect grind and an extraordinary lifetime of the instrument. Compared to other types of stainless steel instruments, needle holders with TC inserts are more sensitive to chemicals and require therefore special care.

INSTRUMENTE MIT TC-EINSÄTZEN

Für unsere Nadelhalter werden TC (Wolframkarbid) Einsätze verwendet, die bei der Härtung einen besonderen Härtegrad (HRC) erzielen, so dass eine aussergewöhnliche Lebensdauer der Instrumente garantiert ist. Im Vergleich zu normalen Edelstahlinstrumenten sind Nadelhalter mit TC-Einsätzen empfindlicher gegenüber Chemikalien und erfordern aus diesem Grund eine besondere Pflege.

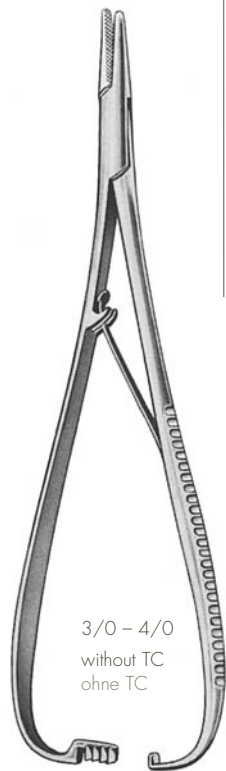

MATHIEU
[14 cm
175/3
175/3 TC



[17 cm
175/2
175/2 TC



3/0 - 4/0
without TC
ohne TC

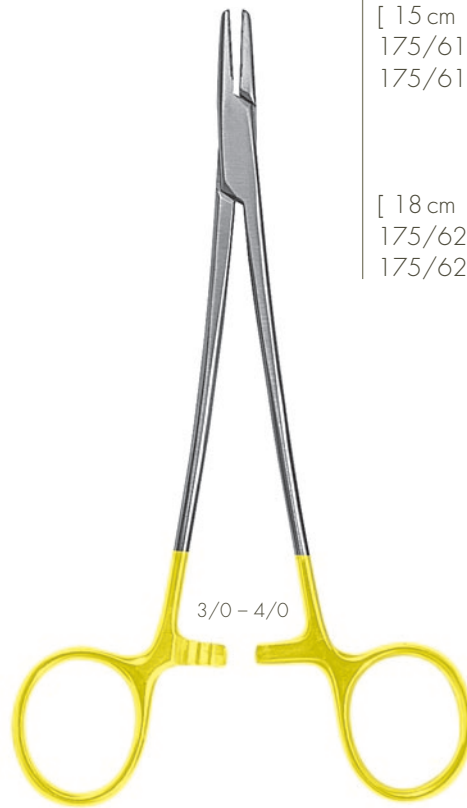

CRILE WOOD
[15 cm
175/61
175/61 TC



[18 cm
175/62
175/62 TC

3/0 - 4/0



OLSEN HEGAR
[14 cm
175/6
175/6 TC



3/0 - 4/0



MAYO HEGAR
[14 cm
175/71
175/71 TC



[16 cm
175/72
175/72 TC

[18 cm
175/73
175/73 TC

3/0 - 4/0



BAUMGARTNER
[14,5 cm
175/14
175/14 **TC**



CRILE MURAY
[15 cm
175/16
175/16 **TC**



DERF
[13cm
175/13
175/13 **TC**



LICHTENBERG
[14 cm
175/51 **TC**



SURGICAL BASIC SET

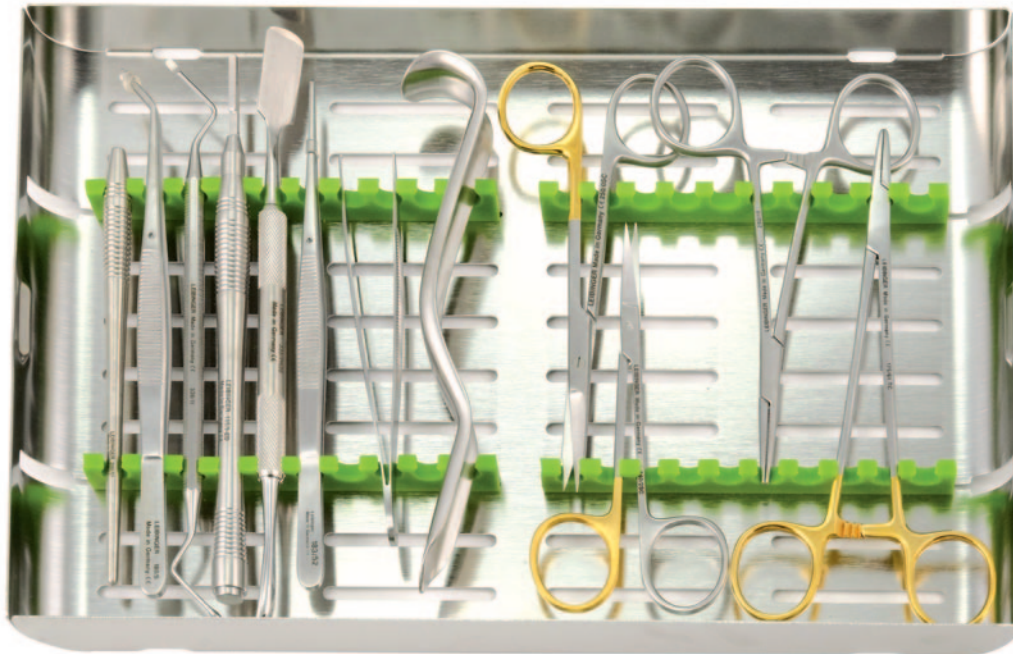

SURGICAL BASIC SET

200/51	Mirror Handle
180/5	London College Tweezers 15cm
185/5-ED	Scalpel Handle straight
335/PR3S	Prichard Raspatories
183/61	Adson Tweezers 12cm delicate 1x2Z
183/52	Semken Tissue Forceps 15cm 1x2Z
250/OSC	Goldman-Fox Scissors curved 13cm / SC
175/61TC	TC Crile-Wood Needle Holder 15cm
240/2SC	Iris Gum Scissors curved 11,5cm SC
354/6	Cawood-Minnesota Cheek Retractor
336/11	Lucas Bone Curette small
290/14	Halstead Mosquito Hemostatic Forceps 14cm
500/3	Wash Tray with Silicon Inserts 288 x 184 x 25mm

CHIRURGIE BASIS SET

Spiegelgriff
London College Pinzette 15cm
Skalpellgriff gerade
Prichard Raspatorium
Adson Pinzette 12cm 1x2Z
Semken chir. Pinzette 15cm 1x2Z
Goldman-Fox Schere gebogen 13cm / SC
TC Crile-Wood Nadel Halter 15cm
Iris Zahnfleischschere gebogen 11,5cm SC
Cawood-Minnesota Wangenhalter
Lucas Kürette klein
Halstead Mosquito Arterienklemme 14cm
Wasch Tray mit Silikoneinsätzen 288 x 184 x 25mm



HALSTEAD MOSQUITO

straight

gerade

[12 cm

290/1

291/11 ☺

[14 cm

290/14

291/14 ☺

curved

gebogen

[12 cm

290/2

291/21 ☺

[14 cm

290/15

291/24 ☺



MICRO-MOSQUITO

straight

gerade

[12 cm

290/11

291/16 ☺

curved

gebogen

[12 cm

290/12

291/26 ☺





KELLY
straight
gerade
[14 cm
290/31

curved
gebogen
[14 cm
290/32



PROVIDENCE-HOSPITAL
straight
gerade
[14 cm
290/35

curved
gebogen
[14 cm
290/36



GROSS-MAIER
Sponge Forceps
Kornzange
[18cm gerade
296/11



BACKHAUS
Towel Clamp
Tuchklemme
[9cm
298/31
[11cm
298/32

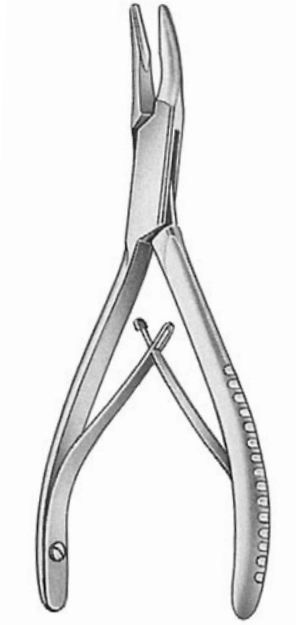

MINI FRIEDMANN
[12 cm
136/01

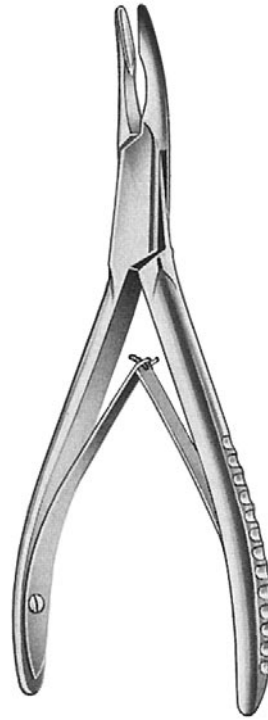

FRIEDMANN
[14 cm
136/0

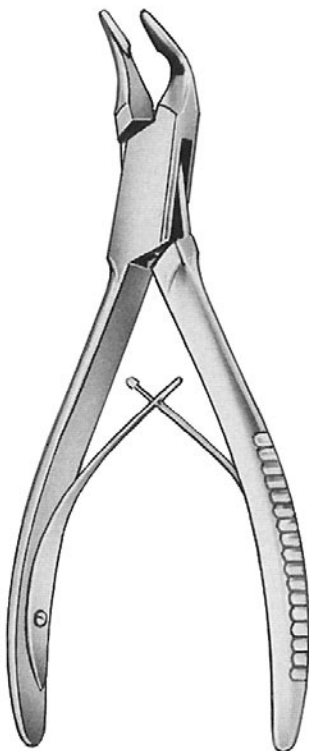

BLUMENTHAL
[15,5cm



136/31

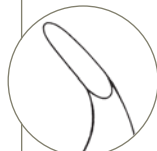

136/32

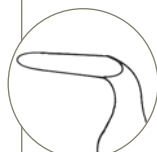

136/33



LUER
[15cm



136/51

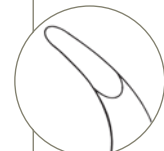

136/52



136/53



HARTMANN
[18 cm
136/4



BÖHLER
[15 cm
137/1



Shaft Shaft Ø 1,6mm

Not approved
by FDA
Nicht von der
FDA zugelassen

ELECTRODES ELEKTRODEN

- standard pattern with black isolation tube and rigid shaft, available from fig. 1 to fig.36
mit schwarzer Isolation und starrem Schaft (Standardversion) erhältlich von Fig.1– Fig.36
- with yellow isolation tube and malleable shaft, available from fig. 1 to fig.24 (for cutting electrodes)
mit gelber Isolation und biegsamem Schaft erhältlich von Fig.1– Fig.24 (für schneidende Elektroden)
- with blue isolation tube and malleable shaft, available from fig.31 to fig.36 (for coagulation electrodes)
mit blauer Isolation und biegsamem Schaft erhältlich von Fig.31– Fig.36 (Koagulations-Elektroden)

- » Please take notice of instruction for use
- » Bitte beachten Sie die Gebrauchsanweisung

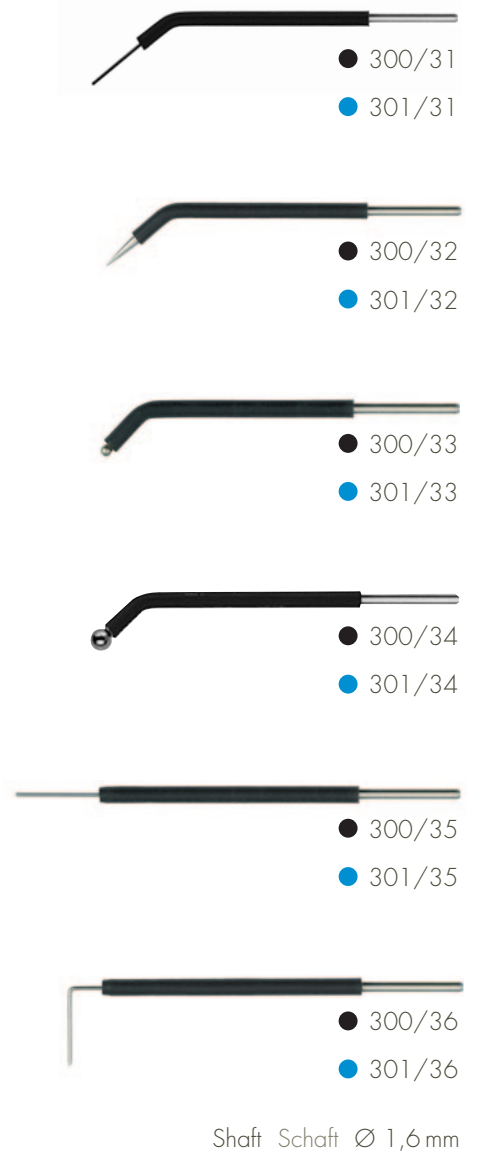

EHRICKE

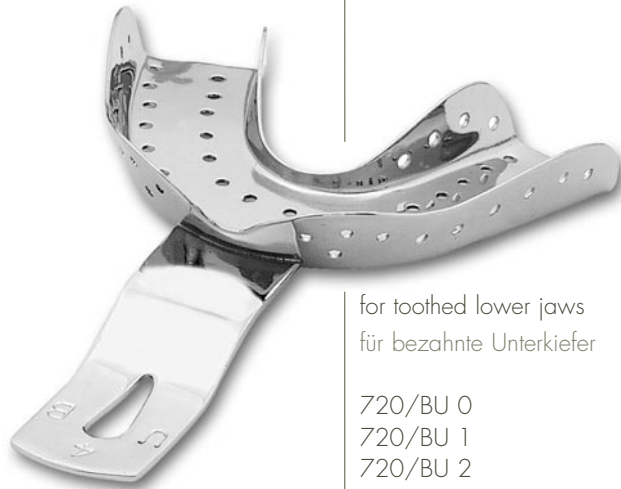

for toothed lower jaws
für bezahnte Unterkiefer

720/BU 0
720/BU 1
720/BU 2
720/BU 3
720/BU 4



for partially toothed lower jaws
für partiell bezahnte Unterkiefer

720/PU 1
720/PU 2
720/PU 3

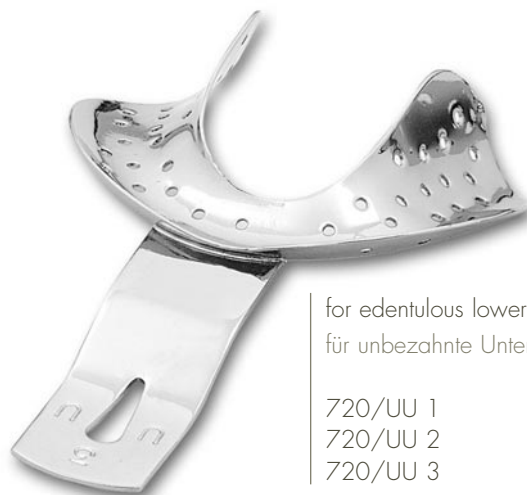

for edentulous lower jaws
für unbezahnte Unterkiefer

720/UU 1
720/UU 2
720/UU 3

EHRICKE

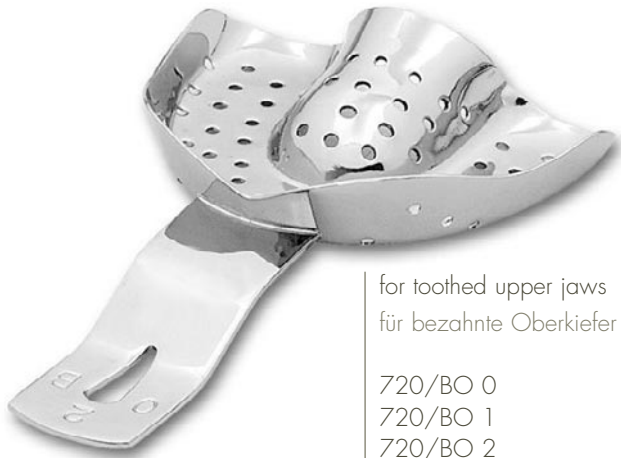

for toothed upper jaws
für bezahnte Oberkiefer

720/BO 0
720/BO 1
720/BO 2
720/BO 3
720/BO 4



for partially toothed upper jaws
für partiell bezahnte Oberkiefer

720/PO 1
720/PO 2
720/PO 3



for edentulous upper jaws
für unbezahnte Oberkiefer

720/VO 1
720/VO 2
720/VO 3



ANGER L-DENT





Bone Scraper, straight
of stainless steel
Knochenschaber, gerade
aus rostfreiem Stahl
[155 mm
800/1

Spare blade straight
Ersatzklinge gerade
800/1A

Bone Scraper, curved
of stainless steel
Knochenschaber, gebogen
aus rostfreiem Stahl
[155 mm
800/2

Spare blade, curved
Ersatzklinge, gebogen
800/2A



[175 mm
811/SL5F



[175 mm
811/SL5F-ED



[175 mm
811/SL6F

COMPACTOR

Compactors to place or compress bone substitute or autologous bone material.

STOPFER

Stopfer zum Einbringen und Verdichten von Knochenaufbaumaterial bzw. autologem Knochen.

BONE SCRAPER

The bone scraper enables you to scrape, collect and transplant the patient's own bone. The bone is collected in a chamber during the scraping and at the same time the bone is being mixed with blood. The bone material can be implanted directly out of the bone scraper which has been sterilized before. The blade should be replaced after 30 applications.

KNOCHENSCHABER

Der Knochenschaber dient zum Schaben und Sammeln von Eigenknochen für die Transplantation. Während des Schabens wird der Knochen in einer Kammer gesammelt und gleichzeitig mit Blut vermischt. Das Knochenmaterial kann direkt aus dem zuvor sterilisierten Knochenschaber implantiert werden. Bis zu 30 Anwendungen sind mit einer Klinge möglich.



SUCTION TUBES
to collect the extracted
bone material

SAUGKANÜLEN
zum Auffangen
des gewonnenen
Knochenmaterials

coarse

grob
[180mm
Ø 5 mm
806/20

fine

fein
Ø 9 mm
806/21



BONE APPLICATOR
to insert the extracted
bone compound

KNOCHEN APPLIKATOR
zum Einbringen
der gewonnenen
Eigenknochenmasse

Ø 2,5 mm / 3,5 mm
[170 mm
806/1

Ø 3,5 mm / 4,5 mm
[170 mm
806/2

Ø 4,5 mm / 5,5 mm
[170 mm
806/3



Compactor
Knochenstopfer
[170 mm
401/C1



Compactor
Knochenstopfer
[170 mm
401/C2



Granulate Plugger
Granulatstopfer
[190mm, Ø3,5/4,5mm
335/2

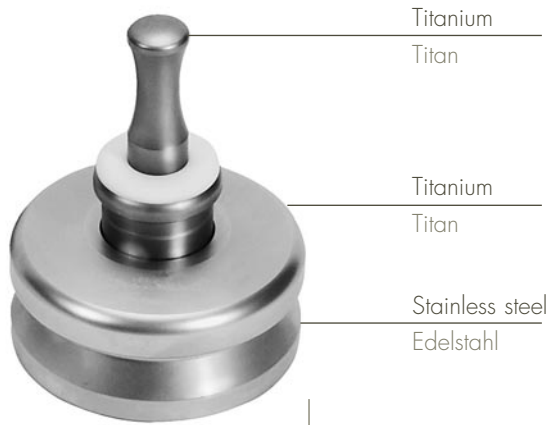

Titanium

Titan

Titanium

Titan

Stainless steel

Edelstahl

EASY BONE
Manual Bone Mill
to chop bone fragments
Manuelle Knochenmühle
zur Zertrümmerung von
Knochenfragmenten
900/5



Bone Mill with
Titanium Grinding Gear
Knochenmühle
mit Titanmahlwerk
900/6

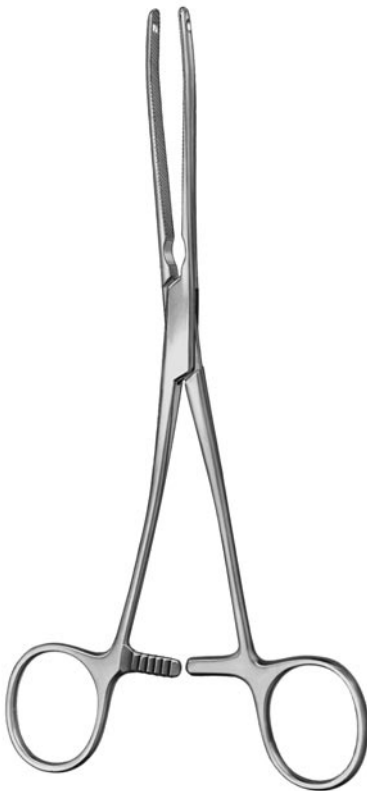

ARNOLD
Bone Graft Holding
and Drilling Forceps
ARNHOLD
Fass- und Bohrzange
für Knochentransplantate
[200mm
801/A



SMITH-RAMUS
Bone Spreader
SMITH-RAMUS
Knochenspreizzange
[235mm
801/S



ARNOLD angled
Bone Graft Holding
and Drilling Forceps
ARNHOLD gewinkelt
Fass- und Bohrzange
für Knochentransplantate
[200mm
802/A

TITANIUM TITAN

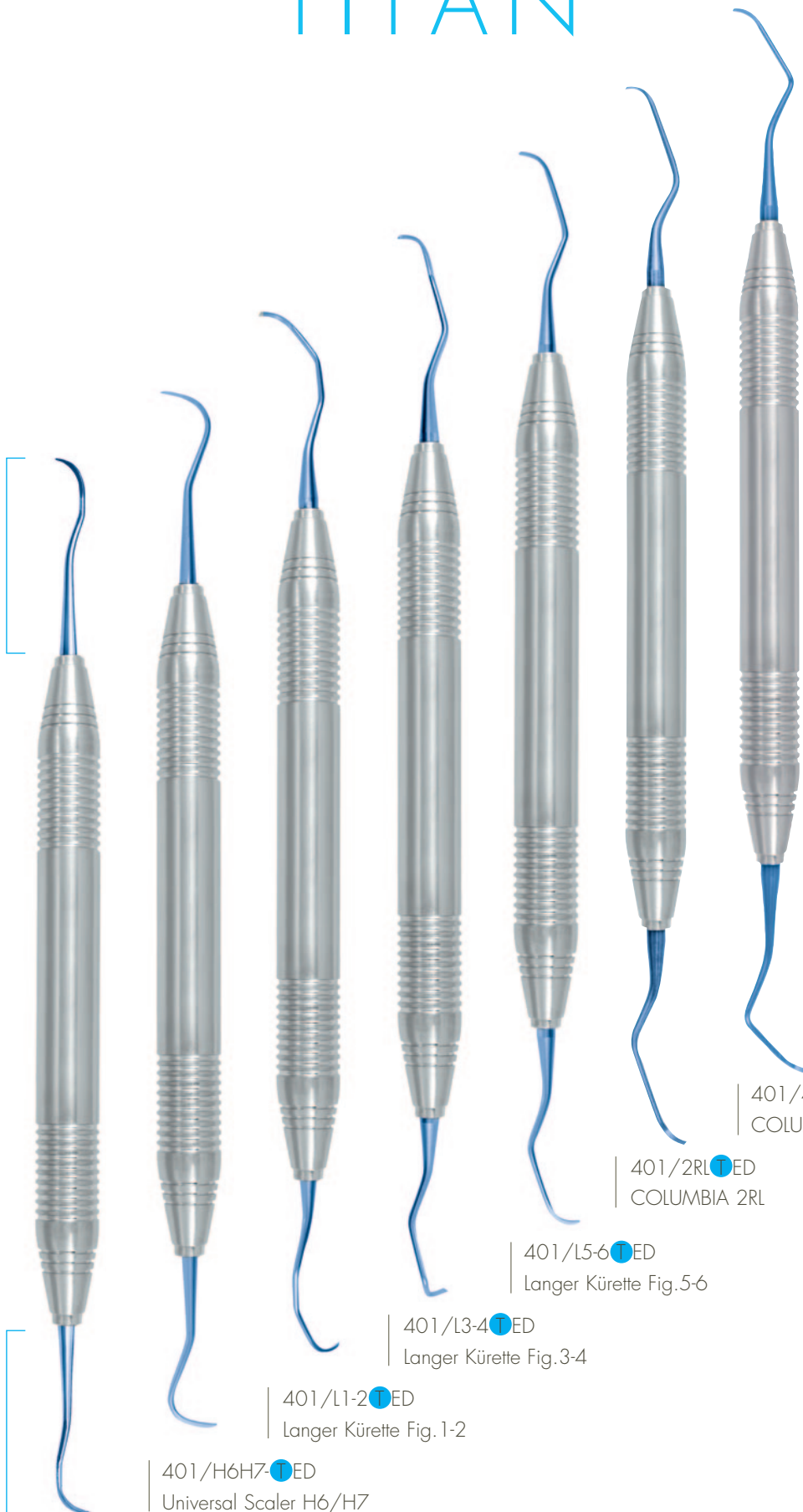

ERGODESIGN Titanium Currettes with extremely light handle and tips made of Titanium especially applicable to clean implants. By using Titanium for the tips, a damage of the surface of the implants will be avoided. The L-Light Titanium Currettes are currently available in 7 different pattern.

ERGODESIGN Titan Kùretten mit federleichtem Griff und Arbeitsenden aus Titan, ideal für die Reinigung von Implantaten. Durch die Verwendung von Titan für die Spitzen wird eine Beschädigung der Implantatoberfläche vermieden. Die L-Light Titan Kùretten sind in 7 verschiedenen Ausführungen erhältlich.

401/4RL^TED
COLUMBIA 4RL

401/2RL^TED
COLUMBIA 2RL

401/L5-6^TED
Langer Kùrette Fig.5-6

401/L3-4^TED
Langer Kùrette Fig.3-4

401/L1-2^TED
Langer Kùrette Fig.1-2

401/H6H7^TED
Universal Scaler H6/H7

401/204SD^TED
Universal Scaler 204SD



BRANEMAAK
[150mm
700/2



[170mm
700/6



353/7



[160mm
354/6



BOWDLER HENRY
[190mm
353/12



OBWEGESER

Mandibular Chanel Retractor
Progeniehaken
8 mm, [175 mm
353/20

10 mm, [175 mm
353/21



OBWEGESER
Ramus Retractor
Ramushaken
72x11mm, [220mm
353/5

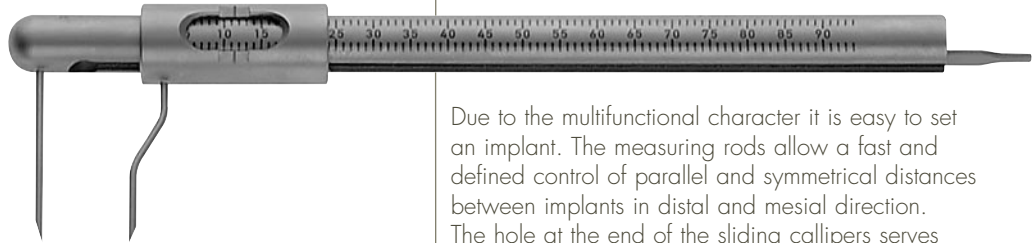

MEASURING GAUGE

MESSLEHRE

0 – 10cm

800/5

Due to the multifunctional character it is easy to set an implant. The measuring rods allow a fast and defined control of parallel and symmetrical distances between implants in distal and mesial direction. The hole at the end of the sliding callipers serves as a drilling gauge, drilling guide and depth measurement.

Durch die multifunktionale Eigenschaft der Messlehre sind viele Funktionen zum Setzen von Implantaten erleichtert. Mit den Messdornen können parallele und gleichmäßige Implantatsabstände in distaler und mesialer Richtung ermittelt werden. Die Durchgangsbohrung im hinteren Bereich des Instrumentes dient als Bohrlehre, Bohrführung und Tiefenmesser.

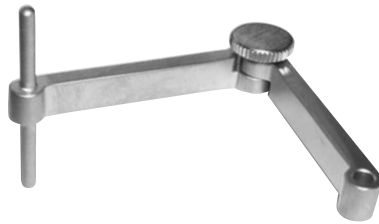

PARALLEL DRILLING GUIDE:

By tightening the fixing screw of this drilling guide it is being ensured to keep the exact distance while setting the implants.

PARALLELBOHRHILFE:

Durch Fixierung der Feststellschraube an dieser Bohrhilfe können beim Setzen von Implantaten die Abstände genau eingehalten werden.

with 2,0mm drilling hole

mit 2,0mm Bohrung

800/51

with 2,5mm drilling hole

mit 2,5mm Bohrung

800/51-25

CASTROVIEJO CALIPERS
CASTROVIEJO ZIRKEL
20mm, [90mm
215/6



CASTROVIEJO CALIPERS
CASTROVIEJO ZIRKEL
20mm, 45°, [90mm
215/7



CASTROVIEJO CALIPERS
CASTROVIEJO ZIRKEL
20mm, [90mm
215/8

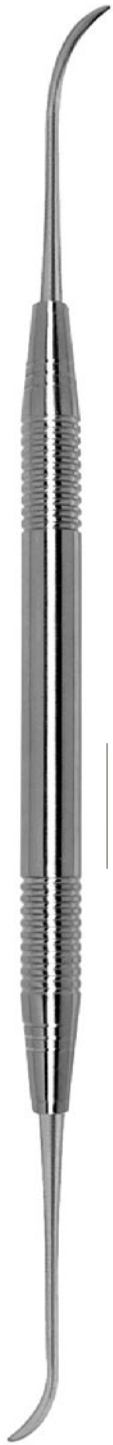

blunt
stumpf
[190 mm
813/SL1



blunt
stumpf
[190 mm
813/SL2

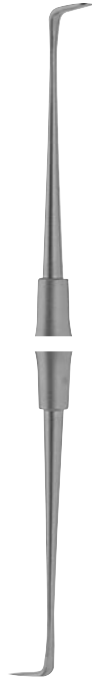

blunt
stumpf
[190 mm
813/SL3



blunt
stumpf
[190 mm
813/SL4

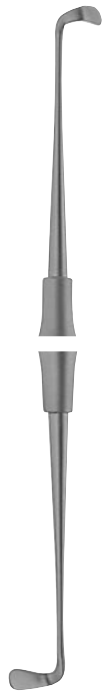

blunt
stumpf
[190 mm
813/SL5



blunt
stumpf
[190 mm
813/SL6



blunt
stumpf
[190 mm
813/SL8



blunt
stumpf
[190 mm
813/SL9



[170 mm
813/SL14



SINUS LIFT CURETTES FLEXIBLE FLEXIBLE SINUS LIFT KÜRETTEN

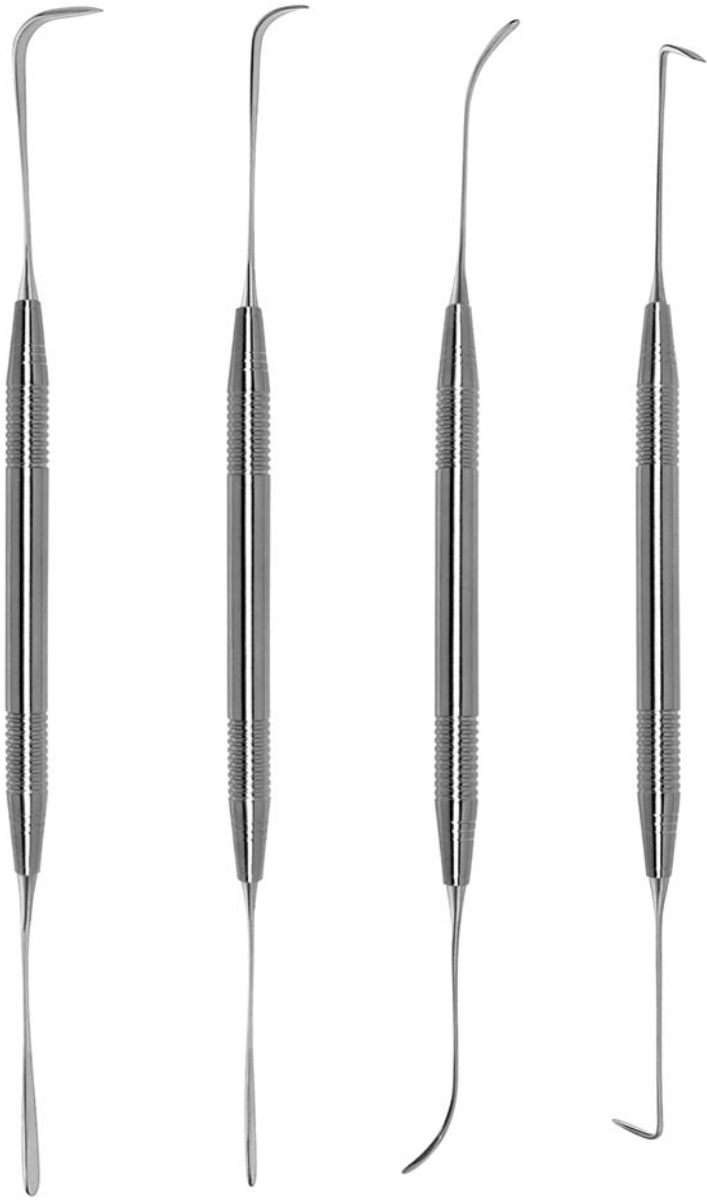

| 811/SL1F-ED | 811/SL2F-ED | 811/SL3F-ED | 811/SL4F-ED

These new Sinus Lift instrument set for the direct sinus lift increases the sensitivity during operation and reduces the risk of perforating the „Schneider´sche membrane“ – due to the unique swing-effect.

Dieses Sinus Lift Instrumentarium für den direkten Sinus Lift erhöht durch den einmaligen Schwingeffekt – das operative Feingefühl und verringert die Perforationsgefahr der „Schneider´schen Membrane“.



Tray suitable for flexible Sinus Lift and Accessories
Tray passend für flexible Sinus Lift und Zubehör
274 x 80 x 41mm
500/4



BONE SPREADING SYSTEM KNOCHENERWEITERUNGSSYSTEM

Universal applicable Instrument System to locally enlarge the bones before the implantation.

Universell einsetzbares Instrumentensystem zur lokalen Erweiterung des Knochens vor der Implantation.

NEW with color identification for more safety and effectiveness!

NEU mit Farbcodierung für mehr Sicherheit und Effektivität!

- 2,2mm ●
- 2,8mm ●
- 3,4mm ●
- 4,0mm ●



[170 mm

- 816/22-ED
- 816/28-ED
- 816/34-ED
- 816/40-ED

- 816/22
- 816/28
- 816/34
- 816/40

[170mm

- 817/22
- 817/28
- 817/34
- 817/40

- 817/22-ED
- 817/28-ED
- 817/34-ED
- 817/40-ED

INSTRUMENTS WITH ERGODESIGN HANDLE

- Ergonomic shape for comfortable and non-exhausting working even over a long period
- Safe grip even during working with wet hands or gloves because of the special serration
- Modern and shapely design
- Easy cleaning
- Available for sinus lift currettes, chisels and osteotomes

INSTRUMENTE MIT ERGODESIGN-GRIFF

- Ergonomische Form für komfortables und ermüdungsfreies Arbeiten
- Sicherer Grip auch beim Arbeiten mit Handschuhen und feuchten Händen durch die rutschhemmende Riffelung
- Formschönes und modernes Design
- Problemlose Reinigung
- Erhältlich für Sinus Lift Küretten, Meißel und Osteotome

ERGODESIGN



straight
gerade
4,0 mm, [170 mm
812/1

7,5 mm, [170 mm
812/3

curved
gebogen
4,0 mm, [170 mm
812/2

7,5 mm, [170 mm
812/4

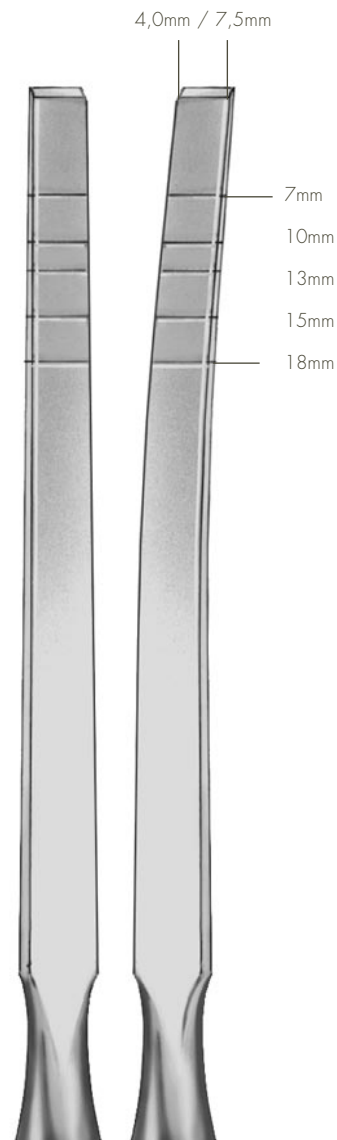

ERGODESIGN



840/20	∅ 2,0mm [160mm
840/27	∅ 2,7mm [160mm
840/32	∅ 3,2mm [160mm
840/37	∅ 3,7mm [160mm
840/42	∅ 4,2mm [160mm
840/50	∅ 5,0mm [160mm
840/60	∅ 6,0mm [160mm

CONVEX

841/20	∅ 2,0mm [160mm
841/27	∅ 2,7mm [160mm
841/32	∅ 3,2mm [160mm
841/37	∅ 3,7mm [160mm
841/42	∅ 4,2mm [160mm
841/50	∅ 5,0mm [160mm
841/60	∅ 6,0mm [160mm

CONCAVE

842/20	∅ 2,0mm [160mm
842/27	∅ 2,7mm [160mm
842/32	∅ 3,2mm [160mm
842/37	∅ 3,7mm [160mm
842/42	∅ 4,2mm [160mm
842/50	∅ 5,0mm [160mm
842/60	∅ 6,0mm [160mm



843/20	∅ 2,0mm [175mm
843/27	∅ 2,7mm [175mm
843/32	∅ 3,2mm [175mm
843/37	∅ 3,7mm [175mm
843/42	∅ 4,2mm [175mm
843/50	∅ 5,0mm [175mm
843/60	∅ 6,0mm [175mm

CONVEX

844/20	∅ 2,0mm [175mm
844/27	∅ 2,7mm [175mm
844/32	∅ 3,2mm [175mm
844/37	∅ 3,7mm [175mm
844/42	∅ 4,2mm [175mm
844/50	∅ 5,0mm [175mm
844/60	∅ 6,0mm [175mm

CONCAVE

845/20	∅ 2,0mm [175mm
845/27	∅ 2,7mm [175mm
845/32	∅ 3,2mm [175mm
845/37	∅ 3,7mm [175mm
845/42	∅ 4,2mm [175mm
845/50	∅ 5,0mm [175mm
845/60	∅ 6,0mm [175mm



CONVEX

848/20	∅ 2,0mm [160mm
848/27	∅ 2,7mm [160mm
848/32	∅ 3,2mm [160mm
848/37	∅ 3,7mm [160mm
848/42	∅ 4,2mm [160mm
848/50	∅ 5,0mm [160mm

CONCAVE

849/20	∅ 2,0mm [160mm
849/27	∅ 2,7mm [160mm
849/32	∅ 3,2mm [160mm
849/37	∅ 3,7mm [160mm
849/42	∅ 4,2mm [160mm
849/50	∅ 5,0mm [160mm



CONVEX

851/20	∅ 2,0mm [175mm
851/27	∅ 2,7mm [175mm
851/32	∅ 3,2mm [175mm
851/37	∅ 3,7mm [175mm
851/42	∅ 4,2mm [175mm
851/50	∅ 5,0mm [175mm

CONCAVE

852/20	∅ 2,0mm [175mm
852/27	∅ 2,7mm [175mm
852/32	∅ 3,2mm [175mm
852/37	∅ 3,7mm [175mm
852/42	∅ 4,2mm [175mm
852/50	∅ 5,0mm [175mm

ERGODESIGN

QUALITY
IS QUALITÄT IST
OUR UNSERE
 TRADITION
TRADITION

Hollow handle
Hohlgriff
Ø 8mm



Round handle solid
Rundgriff massiv
Ø 6mm



ERGODESIGN
ERGODESIGN
Ø 8mm



Papilla elevator
Papillenheber
[170mm
335/PH1



GLICKMAN 24 GSP
335/24GSP
335/24GSP-ED



BUSER
[170mm
335/B1
335/B1-ED

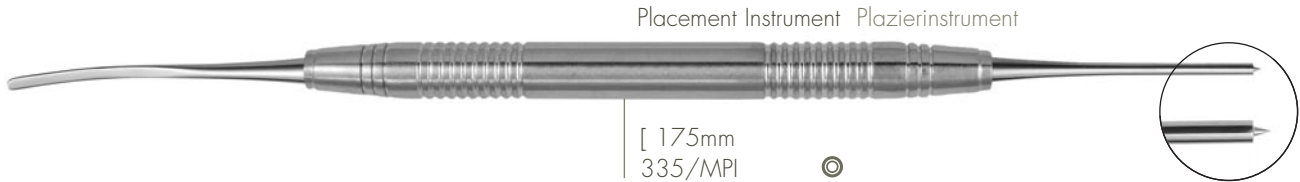

Placement Instrument Plazierinstrument

[175mm
335/MPI



ORBAN 1-2
401/KO12



RHODES BACK-ACTION
401/RBA



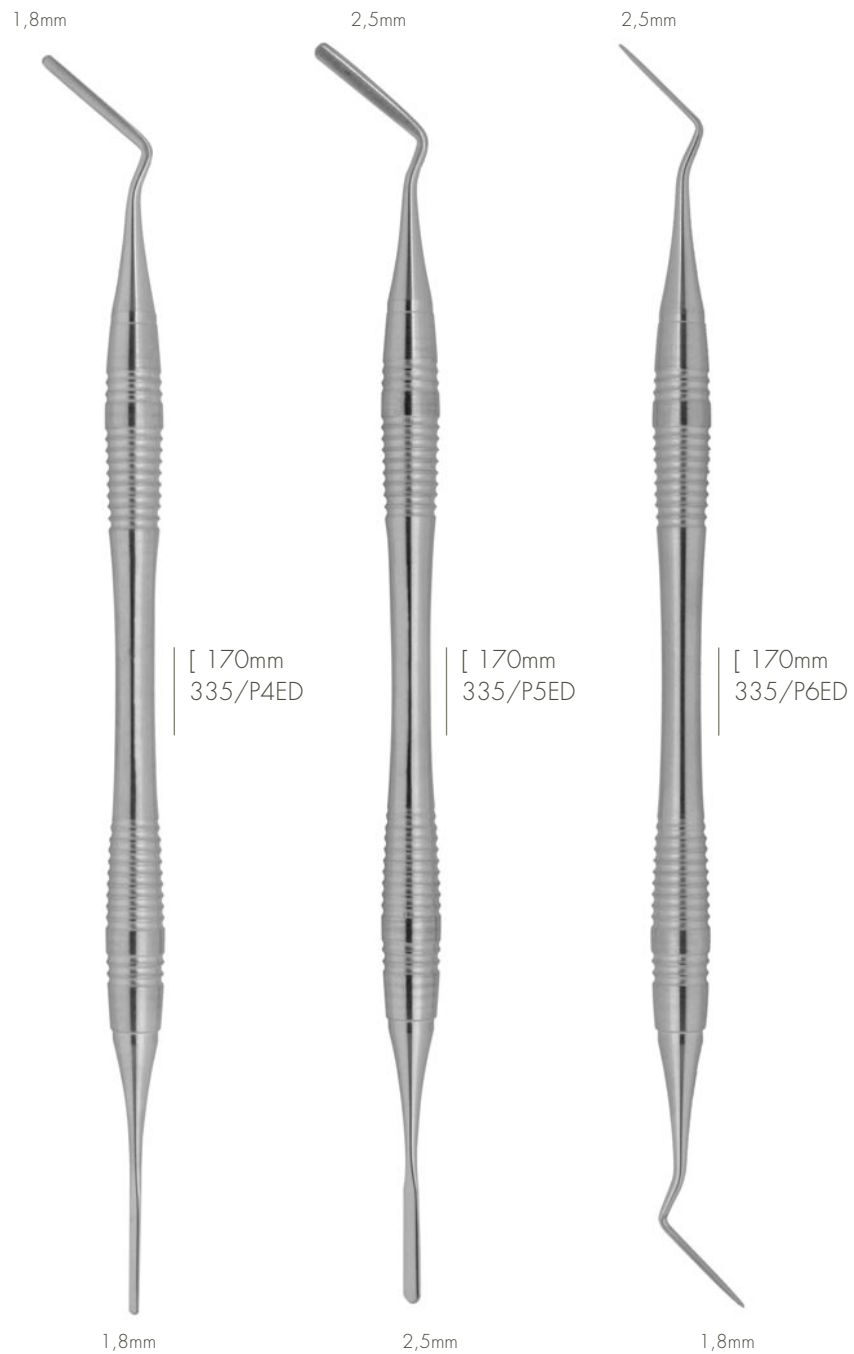

PERIOTOMES

The specific instrument for atraumatic teeth extraction before implants are placed. No cortical bone damage with this instrument, it cuts the periodontal ligament carefully and easily.

PERIOTOME

Zur atraumatischen Trennung der Scharpey'schen Fasern im PA-Spalt zur schonenden Extraktion.

LUXATORS LUXATOREN

The LEIBINGER ERGODESIGN Luxators are used for severing the delicate fibres connecting the tooth root with the jaw bone (ligaments) and extending the tooth socket (alveolus) thus releasing the tooth from the bone and allowing it to be removed easily. This allows the tooth to be extracted gently, which is ideal preparation for implantation.

Mit den LEIBINGER ERGODESIGN Luxatoren können die feinen Fasern, die die Zahnwurzel mit dem Kieferknochen verbinden (Ligamente) durchtrennt und das Zahnfach (Alveole) aufgeweitet werden, so dass der Zahn die Verbindung zum Knochen verliert und leicht entfernt werden kann. Somit erhalten Sie eine schonende Extraktion, ideal für die Vorbereitung einer Implantation.



3 mm	190/L1ST-ED	190/L1C-ED	190/3ST-ED	190/3C-ED
4 mm	190/L2ST-ED	190/L2C-ED	190/4ST-ED	190/4C-ED
4,5 mm			190/45ST-ED	190/45C-ED



Forceps
with tying plate
Pinzette
mit Fadenplatte
[150mm
184/20
[180mm
184/21



1x2 Z
[150mm
184/24
[180mm
184/25



Scissors
straight
Schere
gerade
[150mm
251/31

[180mm
251/32

curved
gebogen
[150mm
251/33

[180mm
251/34



5/0 - 7/0

CASTROVIEJO
straight
gerade
[140mm
174/55 TC



curved
gebogen
[140mm
174/57 TC



6/0 - 8/0

BARAQUER
straight
gerade
[180mm
174/66 TC



CASTROVIEJO
straight
gerade
[140mm
174/59 TC



curved
gebogen
[140mm
174/60 TC



5/0 - 7/0

TITANIUM TITAN



Needle holder
straight

Nadelhalter
gerade
[150mm
174/80 

[180mm
174/81 

curved
gebogen
[150mm
174/82 

[180mm
174/83 



Scissors
straight

Schere
gerade
[150mm
251/31 

[180mm
251/32 



curved
gebogen
[150mm
251/33 

[180mm
251/34 



Forceps
with tying plate

Pinzette
mit Fadenplatte
[150mm
184/20 

  1x2 Z
[150mm
184/24 

IMPLANT MAINTENANCE



IMPLANT MAINTENANCE

IMPLANTAT REINIGUNGS SET





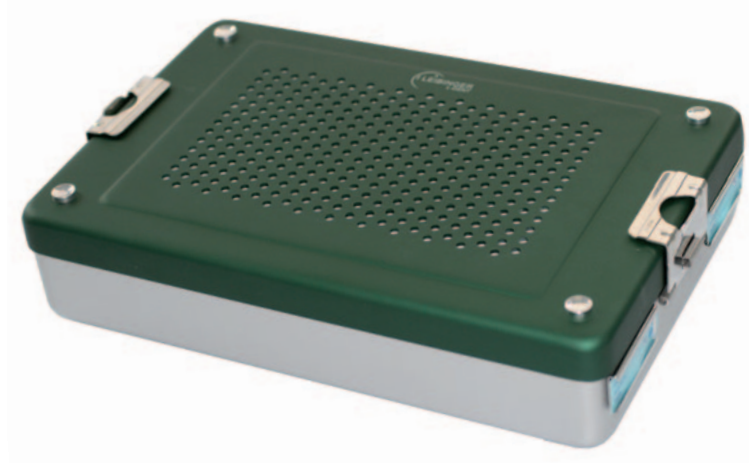

401/L1-2T-ED	Langer Titanium - Curette Fig. 1-2	Langer Titan - Kürette Fig. 1-2
401/L3-4T-ED	Langer Titanium - Curette Fig. 3-4	Langer Titan - Kürette Fig. 3-4
401/L5-6T-ED	Langer Titanium - Curette Fig. 5-6	Langer Titan - Kürette Fig. 5-6
401/204SDT-ED	Titanium-Scaler 204SD	Titan Universal Scaler 204SD
401/H6-H7T-ED	Titanium Scaler H6-H7	Titan Universal Scaler H6-H7
405/WHO-T-ED	PA-Probe WHO, TiN coated	WHO Parosonde TiN beschichtet
180/9T	Titanium Meriam Tooth Tweezers	Meriam Zahnpinzette Titan
335/GF14-ED	Goldman-Fox Raspatories GF 14	Goldman-Fox Raspatorium GF 14
335/24GSP-ED	Glickman Raspatories 24GSP	Glickman Raspatorium 24 GSP
500/T	Wash Tray with Silicon Inserts 184 x 150 x 25mm	Wasch Tray mit Silikoneinsätzen 184 x 150 x 25mm

DENTAL CONTAINER DENTAL-CONTAINER



- Aluminium
- Light but robust design
- Stackable
- Lid perforated, available in 6 colors
- Aluminium
- leicht und robust
- stapelbar
- Deckel gelocht in 6 Farben erhältlich



L x B x H						
310 x 190 x 40 mm	510/40	511/40	512/40	513/40	514/40	515/40
310 x 190 x 65 mm	510/65	511/65	512/65	513/65	514/65	515/65
310 x 190 x 130 mm	510/130	511/130	512/130	513/130	514/130	515/130

Tested and validated with original LEIBINGER filters and components. Further accessories on request.
Geprüft und validiert mit original LEIBINGER Filter und Komponenten. Weiteres Zubehör auf Anfrage.

FILTER FILTER

PAPER FILTER, single use only PAPIERFILTER, einmalige Anwendung 516/01	1000 pcs. 1000 Stück/Packung
TEXTILE FILTER, up to 50 sterilization cycles TEXTILFILTER, bis zu 50 Sterilisationszyklen 516/02	1 pc. 1 Stück/Packung
TEFLON FILTER, up to 1200 sterilization cycles TEFLONFILTER, bis zu 1200 Sterilisationszyklen 516/03	1 pc. 1 Stück/Packung



ERGO-CLIP Wash Tray
allows visible and ordered
storage of 5 Instruments
ERGO-CLIP Wasch Tray
zur sichtbaren und geordneten
Lagerung und Reinigung
von 5 Instrumenten

184 x 110 x 25 mm
500/TK



ERGO-CLIP Wash Tray
allows visible and ordered
storage of 10 Instruments
ERGO-CLIP Wasch Tray
zur sichtbaren und geordneten
Lagerung und Reinigung
von 10 Instrumenten

184 x 150 x 25 mm
500/T



ERGO CASSETTE Wash Tray
allows visible and ordered
storage of 10 Instruments
ERGO CASSETTE Wasch Tray
zur sichtbaren und geordneten
Lagerung und Reinigung
von 10 Instrumenten

184 x 150 x 25mm
500/1

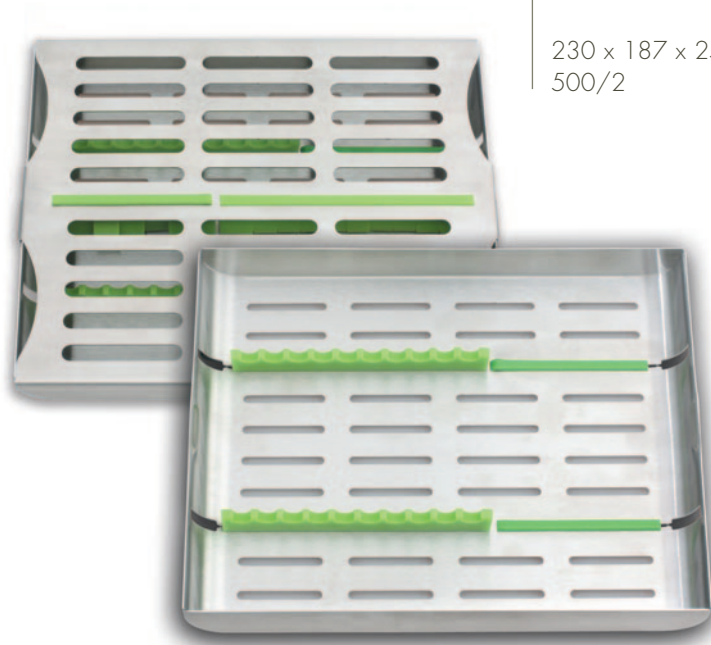

ERGO CASSETTE Wash Tray
allows visible and ordered storage
of 10 Instruments and accessories

ERGO CASSETTE Wasch Tray
zur sichtbaren und geordneten Lagerung
und Reinigung von 10 Instrumenten
und Zubehör

230 x 187 x 25 mm
500/2

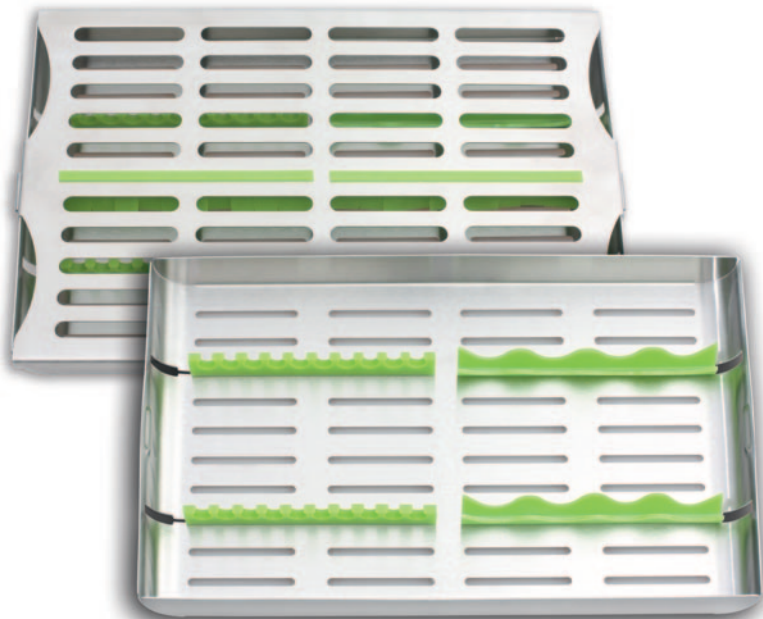

ERGO CASSETTE Wash Tray
allows visible and ordered
storage of 20 Instruments

ERGO CASSETTE Wasch Tray
zur sichtbaren und
geordneten Lagerung
und Reinigung
von 20 Instrumenten

288 x 187 x 25 mm
500/3

EASY TRAY

Retractable clip with a fixed hinge,
easy to open and close.

Aufklappbarer und mit dem Tray
fest verbundener Clip,
leicht zu öffnen und schließen.



EASY TRAY
for 5 Instruments
für 5 Instrumente

180 x 70 x 30mm
500/5



EASY TRAY
for 10 instruments
für 10 Instrumente

180 x 140 x 30mm
500/6

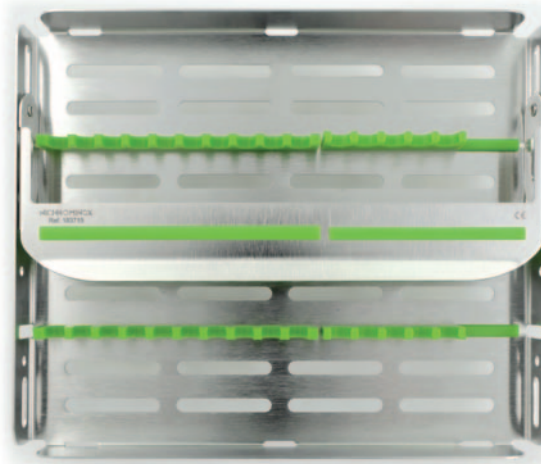

EASY TRAY
for 15 instruments and area for accessories
für 15 Instrumente + Zubehör

210 x 180 x 30mm
500/7

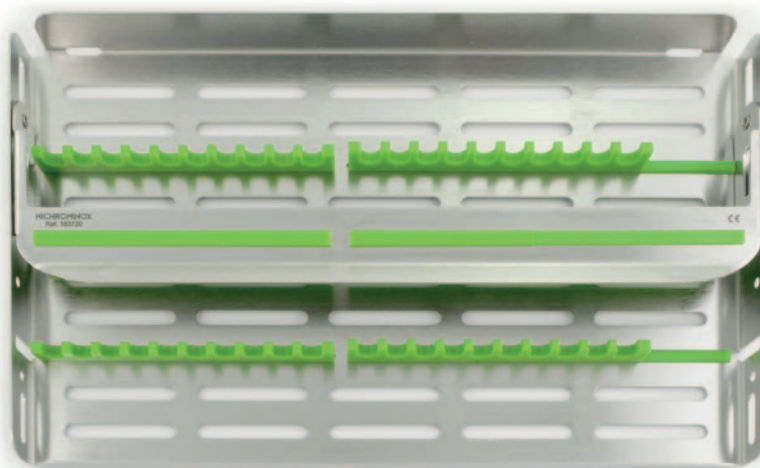

EASY TRAY
for 20 instruments and area for accessories
für 20 Instrumente + Zubehör

280 x 180 x 30mm
500/8

NEW NEU

ORTHO TRAY



Especially for the storage and cleaning of orthodontic pliers and accessories.

Speziell entwickelt für die Aufbewahrung und Reinigung von kieferorthopädischen Zangen und Zubehör.

ORTHO TRAY

180 x 140 x 30mm
500/21

ORTHO TRAY

210 x 180 x 30mm
500/22

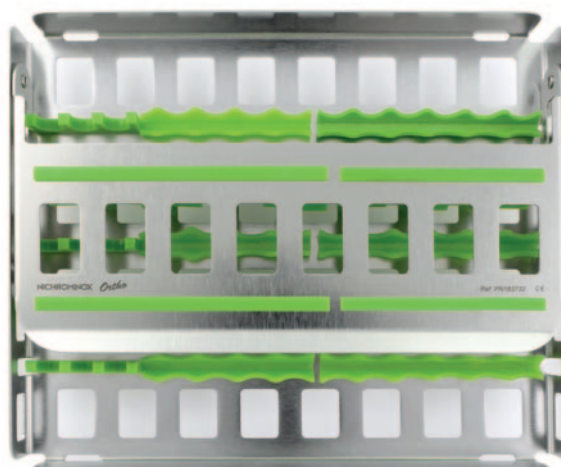

ORTHO TRAY

280 x 180 x 30mm
500/23



Flat Nose Pliers
both sides smooth
Flachzange
beide Seiten glatt
[140mm
630/2

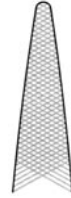

Flat Nose Pliers
both sides serrated
Flachzange
beide Seiten gerieft
[140mm
630/3

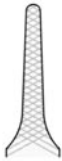

PEESO
Wire Bending Pliers
Drahtbiegezange
[135mm
630/34



Flat Nose Pliers
both sides serrated
with TC inserts
Flachzange
beide Seiten gerieft
mit Hartmetalleinsätzen
[140mm
630/3 TC

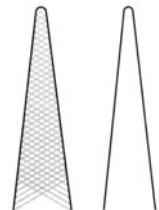

GOSLEE
Flat Nose Pliers
Flachzange
[140mm
630/33



BÖHM
Teleskop Crown Forceps
Teleskopkronenzange
[120mm
255/1



BÖHM
Teleskop Crown Forceps
with interchangeable
diamond tips
Teleskopkronenzange
mit auswechselbaren
Diamanteinsätzen
[120mm
255/31



Pair of replacement
diamond tips
Ersatzpaar
Diamanteinsätze
255/31A



Max. Ø 0,7mm
Max. Ø 1,30 x 0,65mm

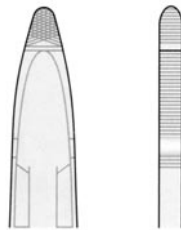

WALDSACHS
Universal Pliers
for soft and hard wire
Universalzange
für weichen und harten Draht
Ø Max. Ø 0,7mm / .028"
□ 1,30 x 0,65mm / .052 x .026"
[150mm
631/3



Max. Ø 0,7mm
Max. Ø 0,9mm

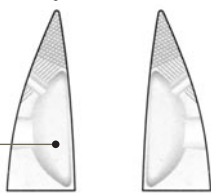

Universal Pliers
for soft and hard wire
Universalzange
für weichen und harten Draht
[160mm
631/5



Max. Ø 0,7mm
Max. Ø 0,9mm

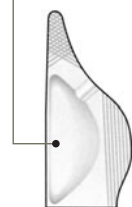

Universal Pliers
for soft and hard wire
Universalzange
für weichen und
harten Draht
[150mm
631/4

CROWN REMOVING FORCEPS KRONENABNEHMEZANGE

- with replaceable plastic inserts to carefully grab and remove crowns and bridges
mit auswechselbaren Kunststoffbacken zum schonenden Greifen/Abnehmen von Kronen und Brücken
- forceps can be used on upper and lower jaws
die Zangen können sowohl für Unter- als auch Oberkiefer verwendet werden
- due to the exchangeable elastic plastic inserts, damages especially on ceramic crowns can be avoided
durch die elastischen Kunststoffbacken werden Beschädigungen, insbesondere an Keramikronen vermieden
- inserts are also sterilizable
die Einsätze sind ebenfalls sterilisierbar



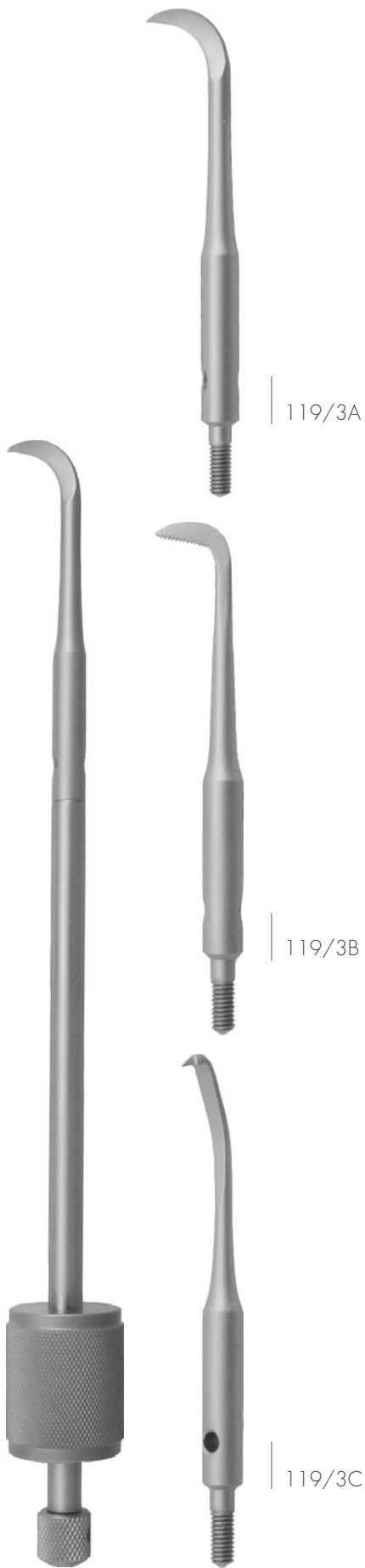

Crown Remover with three tips
Kronenentferner mit drei Einsätzen
119/3



Crown Removing Forceps
Provisorien-Abnehmezange
119/6



MAZOUCH
119/22

CEMENT SPATULAS ZEMENTSPATEL



| 140/1



| 140/2



| 140/3

FLEXIBLE

PK THOMAS



166/1



166/2



166/3



166/4



166/5

- » also available as set
- » auch als Set erhältlich
- » Fig. 1-5 = 166/S

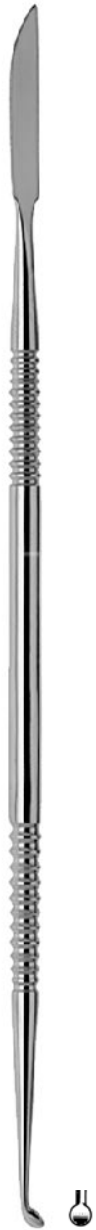

LeCRON
280/1



LeCRON
280/2



ZAHLE
painted
spitz
280/3



IWANSON
Calipper
Tasterzirkel
for metal
für Metall
215/1

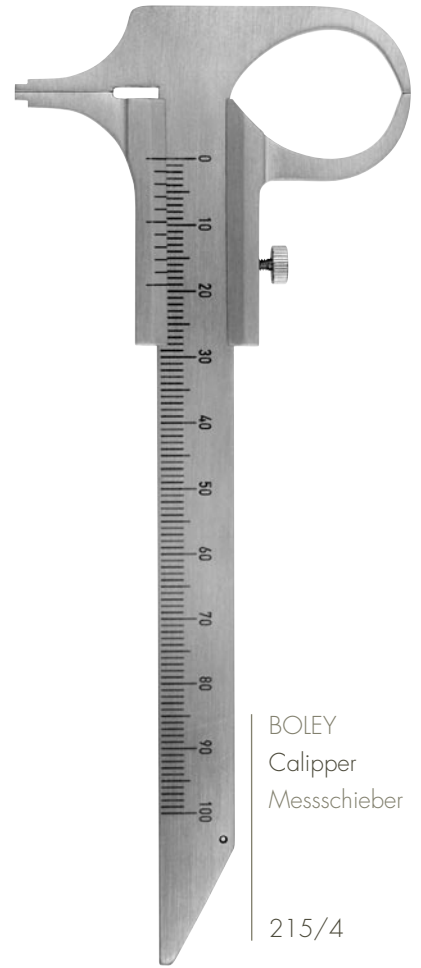

BOLEY
Calipper
Messschieber
215/4

STEAMER NET RICHTER

Usually, for steam cleaning, drying with compressed air, tiny dental lab pieces such as crowns, inlays, bridges and metal bits for implantology are held by hand or with crown holding forceps. The new Richter Steamer Net (D.G.B.M.) is created especially for these operations.

ADVANTAGES

- protection of dental lab pieces during cleaning
- pieces do not get lost or tossed aside
- easy handling, compared to tweezers or crown holding forceps
- modified pressure due to the absorbing and fixing effect of special net covers
- changeable covers

ABDAMPFNETZ RICHTER

Die meisten zahntechnischen Werkstücke wie Kronen, Inlays, Brücken und Metallteile für die Implantologie werden zum Abdampfen/Trocknen von Hand oder mittels eines Handinstrumentes (Kronen-Klemme, Pinzette etc.) gehalten. Mit dem Abdampfnetz Richter (D.G.B.M.) haben Sie nun das optimale Instrument für diesen Anwendungsbereich.

VORTEILE

- schonendes Abdampfen von zahntechnischen Werkstücken
- kein Herumschleudern mehr der abzdampfenden Stücke
- einfaches Greifen im Vergleich zur Pinzette oder Kronen-Klemme
- kontrollierter Druck Dank der dämpfenden und fixierenden Wirkung des speziellen Kunststoffnetzes
- auswechselbarer Netzhalter



RICHTER
Steamer Net
Abdampfnetz
900/2

Replacement Nets/pair
Ersatznetz/Paar
900/2A



FAHNENSTOCK
[130mm
270/1



FAHNENSTOCK
[170mm
270/2



BUFFALO
[130mm
270/6



[170mm
270/8



GRITMANN
[160mm
275/1



Spatula
curved,
narrow
Spatel
leicht gebogen,
schmal
275/3



Spatula
straight, wide
Spatel
gerade, breit
275/4

Spatula
straight, narrow
Spatel
gerade, schmal
275/5



ROGHE
275/6

A	PAGE
ADSON, dissecting forceps	93
ADSON, tissue forceps	95
ADSON BROWN, tissue forceps	95
AINSWORTH, rubber-dam punch	34
Amalgam carriers	36
APICAL, root elevator	73
Applicator, bone	115
ARNOLD, bone forceps	118
ARTHUR, root splinter forceps	71
AUSTIN, retractor	82, 120

B	PAGE
BACKHAUS, towel clamps	105
BARRAQUER, needle holder	100, 134
BARRY, elevators	73, 80
BAUMGARTNER, needle holder	102
BEALE, waxing instrument	29
BEEBEE, crown scissors	98
BEIN, elevators	72
BLACK, filling instruments	19
BLUMENTHAL, bone rongeurs	106
BÖHLER, bone rongeurs	107
BÖHM, telescopic crown forceps	143
BOLEY, caliper	148
Bone applicator	115
condenser	116
files	89
forceps	118
measuring gauge	122-123
mill	117
rongeurs	106-107
scraper	114
spreader	126
BOWDLER-HENRY, retractor	85, 121
BRAANEMARK, cheek retractor	83, 120
BREWER, clamp forceps	34
BRUENINGS, tongue retractor	82
BUCHANAN, plugger	36
BUFFALO, plaster knives	150
Burnishers	14-16, 20
BUSER, raspatories	53, 87, 131

C	PAGE
Calcium hydroxide placer	15
Calipers	123, 148
Carriers, amalgam-	36
Cartridge Syringe	79
Carving Instruments	28
CASTROVIEJO, gauge	123
CASTROVIEJO, needle holders	100, 134
CAWOOD-MINNESOTA, cheek retractor	82, 120
Cement spatulas	26, 146
Cheek retractors	82
Children tooth forceps	62-64, 70
Chisels	50, 89, 131
Clamp forceps	34
Clamps, towel-	105
CLEOID-DISCOID, waxing instrument	28
COLUMBIA, scaler	45
Compactor	114, 116
Compo-Fill instruments	24-25
Cord packers	29
COUPLAND, elevators	74
CRILE MURRAY, needle holder	102
CRILE-WOOD, needle holders	101

C	PAGE
Crown, remover	145
removing forceps	145-146
scissors	98
spreader	145
CRYER, elevators	73
CUMINE, scaler	47
Curettes, periodontal	40-43, 46, 48-49
sinus lift	124-125
titanium	54, 119

D	PAGE
DARBY-PERRY, excavators	22
DEAN, gum scissors	98
Dental Electrodes	108-109
DERF, needle holder	102
Dissecting forceps	92-93
Drilling guide	122
DYCAL, filling instruments	15

E	PAGE
EHRICKE, impression trays	110-111
Electrode, dental	108-109
Elevators,	88
root	72-80
sinus lift	128-129
Endodontic Excavators	21
Endodontic instruments	35-37
Excavators	21-23
Explorer Tips	8
Explorers	6-7
Extracting forceps, American pattern	68-70
English pattern	56-67
for children	62-64, 70

F	PAGE
FAHNENSTOCK, wax knives	150
FARABEUF, retractor	82
Files, bone	89
perio	51
Filling instruments	14-20, 24
remover	29
Filter for sterilization container	137
Flat nose pliers	142
FLOHR, elevators	72
Forceps, articulating paper	12
children	62-64, 70
crown removing	145-146
dissecting	92-93
extracting	56-70
heamostatic	104-105
rubber dam	34
root splinter	71
sponge	105
tissue	94-95
FRAHM, finishing instrument	28
FRAZIER, suction cannula	91
FREER, elevator	88
FRIEDMANN, bone rongeurs	106
Furcation Probe	10

G	PAGE
Gauze packers	29
Gauges	122-123
GILLIES, tissue forceps	95
Gingival margin trimmers	29
cord packers	29
Gingivectomy knives	50

G	PAGE
GLICK, root canal plugger	36
endo excavator	21
GLICKMAN, raspatories	53, 87, 131
GOLDMAN-FOX, gum scissors	96
gingivectomy knives	50
raspatory	53, 87
perio probe	10-11
GOSLEE, flat nose pliers	142
GRACEY, curettes	40-43, 48-49
GRITMAN, plaster knife	150
GROSS-MAIER, sponge forceps	105
Gum scissors	96-98

H	PAGE
Haemostatic forceps	104-105
HALSTEAD-MOSQUITO, haemostatic forceps	104
Handles, mirror	9
scalpel	90
HARTMANN, Hohlmeißelzange	107
HEIDBRINK, elevators	76
HEIDEMANN, spatula	27
HEMINGWAY sharp spoon	89
HIRSCHFELD, perio files	51
Holder for brushes	125
HOLLENBACK, filling instruments	19
waxing instruments	28
HOPSON, filling instrument	15
HOWARTH, elevator	88
HYGIENIST, scaler	44
HYLIN, elevator	75

I	PAGE
Impression trays	110-111
Instrument oil	99
Instrument Trays	138-141
INTERPROXIMAL, waxing-instrument	28
IRIS, gum scissors	96
IVORY, rubber-dam punch	34
IWANSON, Caliper	148

J	PAGE
JOSEPH, gum scissors	97

K	PAGE
KELLY, gum scissors	96
haemostatic forceps	105
KIRKLAND, gingivectomy knife	50
KLEIN, tooth forceps	64
Knives, gingivectomy	50
plaster	150
wax	150
KOCHER-LANGENBECK, retractor	85

L	PAGE
LaGRANGE, gingiva scissors	96
LANGENBECK, retractors	85
LANGER, curettes	46
LeCRON, waxing instruments	148
LICHTENBERG, needle holder	102
Ligature scissors	97
LINDO LEVIAN, luxators	75
Lip retractor	83
LOCKLIN, gum scissors	98
LONDON-COLLEGE, tooth tweezers	12
LUCAS, sharp spoons	89
LUER, bone rongeurs	106
LUNIATSCHECK, gauze packers	29

L	PAGE
Luxators	78-79, 133

M	PAGE
Mallets	86
Mandibular channel retractor	85, 121
Margin trimmers	29
MATHIEU, needle holders	101
Matrix retainers	36
MAYO-HEGAR, needle holders	101
MAZOUCH, crown spreader	145
McCALL, curettes	46
McINDOE, dissecting forceps	93
Measuring gauges	122-123
Measuring probes	10-11
Membrane placing instrument	131
MERIAM, tooth tweezers	12
METZENBAUM, dissecting scissors	98
Micro mirrors	8
Micro needle holders	100, 134-135
scissors	135
tweezers	95, 134-135
MICRO-MOSQUITO, artery forceps	104
MIDDELDORPF, retractors	84
MILLER, articulating paper forceps	12
bone files	89
MINNESOTA, retractor	82, 120
Mirror, handles	9
mouth	8
MITCHEL, scaler	47
MOLT, mouth gag	83
MOLT, raspatories	53, 87
MORTENSON, filling instrument	19, 24
Mouth gag	83
mirrors	8
mirror handles	9
retractors	82-83, 120

N	PAGE
NABERS, perio probe	10
Needle holders	100-102, 134-135
NYSTROEM, carving instrument	29

O	PAGE
OBWEGESER, channel retractor	85, 121
ramus retractor	84, 121
raspatory	88
OCHSENBEIN, chisel	50, 89
OLSEN-HEGAR, needle holders	101
ORBAN, chisel	131
gnigvectomy knife	50
Osteotomes	127

P	PAGE
Papilla elevator	131
Parallel drilling guide	122
PEESO, wire bending pliers	142
Perio files	51
Perio probes	10-11
Periodontal chisels	50
Periodontal knives	50
Periosteal elevators	53, 87, 88
Periotomes	132
PERRY, tooth tweezers	12
PK THOMAS, waxing instruments	19, 24, 147
Placing instrument	15, 131
PLANATOR, filling instrument	17

P	PAGE
Plaster knives	150
spatulas	150
Plastic filling instruments	14-20, 24
Pluggers, root canal	36
POTTS-SMITH, Forceps	92, 94
PRICHARD, raspatories	53, 87
Probes, measuring	10-11
PROVIDENCE-HOSPITAL, haemostatic forceps	105
Punch forceps, rubber-dam	34

R	PAGE
Ramus retractor	84
Raspatories	53, 87-88, 131
PEINWALD, hook	47
Remover, filling-	29
Crown	145
Retractors	82-85, 120-121
Retractors, cheek	82, 120
lip	83
mouth	83, 120
tongue	82
RHODES BACK-ACTION, chisel	50, 131
RICHTER, steamer net	149
ROGHE, plaster spatula	150
Ronguers, bone	106-107
Root canal instruments	35-36
Root elevators	72-80
Root splinter forceps	71
Rubber dam clamps	32-33
Rubber dam instruments	32-34

S	PAGE
Scalers	44-45, 47
Scalpel handles	90
SCHLUGER, perio files	51
Scissors, crown	98
gingiva	96
gum	96-98
ligature	97
micro	134-135
titanium	135
universal	98
wire cutting	98
SELDIN, raspatory	88
SEMKEN, forceps	92, 94
Sharp spoon	89
Sinus lift curettes	124-125
elevators	128-129
SMITH-RAMUS, forceps	118
Spatulas, cement	26, 146
plaster	124
SPENCER, ligature scissors	97
Splinter forceps	71
Sponge forceps	105
Steamer net	149
Sterilization container	137
STERNBERG, lip retractor	83
STIEGLITZ, root splinter forceps	71
STOKE, rubber dam punch	34
Suction tubes	91, 115
SUGARMAN, perio files	51
Suture tweezers	12, 35
Syringes	81

T	PAGE
TAYLOR, scaler	44
Telescopic crown forceps	143

T	PAGE
Tips, explorer-	8
Tissue forceps	94-95
Titanium curettes	54
Titanium instruments	135
TOFFELMIRE, matrix retainer	36
Tongue retractor	82
Towel clamps	105
TOWNER, scaler	44
Trays for instruments	138-141
Trays, impression-	110-111
Tubes, suction	91, 115
TUFFIER, tongue retractor	82
Tunneling instruments	52
Tweezers, dissecting	92, 95
endodontic	35
titanium	135
tooth	12
tissue	94-95
suture	12, 35

U	PAGE
Universal pliers	143
scissors	97
scalers	45

V	PAGE
Vestibulum retractor	83

W	PAGE
WAGNER, gum scissors	97
WALDSACHS, universal pliers	143
WARD, waxing instruments	28
WARWICK-JAMES, elevators	74
Wash trays	138-141
Wax knives	150
Waxing instruments	28, 147-148
WESTCOTT, burnishers	19, 24
WHITE, burnishers	20
WHO, perio probes	11
WIEDER, retractor	82
WILAND, waxing instrument	28
WILLIAMS, perio probe	10-11
WILLIGER, elevator	88
raspatory	88
WINTER, elevators	80
Wire bending pliers	142-143
scissors	97
WITZEL, forceps	71

Z	PAGE
ZAHLE, waxing instrument	148

A	SEITE
Abdampfnetz	149
Abdrucklöffel	110-111
Abnehmezange	144-145
Absaugkanülen	91, 115
ADSON, anatomische Pinzette	93
ADSON, chirurgische Pinzette	95
ADSON BROWN, chirurgische Pinzette	95
AINSWORTH, Kofferdam-Lochzange	34
Amalgam-Instrumente	14-20
-Applikatoren	30
Anatomische Pinzetten	92-93
APICAL, Wurzelheber	73
ARNOLD Knochenzange	118
Arterienklemmen	104-105
ARTHUR, Wurzelsplitterzange	71
Artikulationspinzette	12
Aufwachsinstrumente	147
AUSTIN, Wundhaken	82, 120
B	
BACKHAUS, Tuchklemme	105
BARRAQUER, Nadelhalter	100, 134
BARRY, Wurzelheber	73, 80
BAUMGARTNER, Nadelhalter	102
BEALE, Modellierinstrument	29
BEEBEE, Kronenschere	98
BEIN, Wurzelheber	72
BLACK, Füllungsinstrument	19
BLUMENTHAL, Hohlmeißelzange	106
BÖHLER, Hohlmeißelzange	107
BÖHM, Teleskopkronenzange	143
BOLEY, Messlehre	148
BOWDLER-HENRY, Wundhaken	82, 121
BRAANEMARK, Mundvorhofhaken	83, 120
BREWER, Klammerzange	34
BRÜNINGS Zungenspatel	82
BUCHANAN Wurzelkanalstopfer	36
BUFFALO, Gipsmesser	150
BUSER, Raspatorium	53, 87, 131
C	
Calcium Hydroxid Platzierinstrument	15
CASTROVIEJO, Messzirkel	123
Nadelhalter	100, 134
CAWOOD-MINNESOTA, Wangenhalter	82, 120
Chirurgische -Pinzetten	94-95
CLEOID-DISCOID, Modellierinstrument	28
COLUMBIA, Kürette	45
Compo Fill Instrumente	24-25
COUPLAND, Wurzelheber	74
CRILE MURRAY, Nadelhalter	102
CRILE-WOOD, Nadelhalter	101
CRYER, Wurzelheber	73
CUMINE, Zahnreiniger	47
D	
DARBY-PERRY, Excavatoren	22
DEAN, Zahnfleissschere	98
Dental-Elektroden	108-109
DERF, Nadelhalter	102
DISCOID-CLEOID, Modellierinstrumente	28
Drahtbiegezangen	142-143
Drahtscheren	98
DYCAL, Füllungsinstrumente	15
E	
EHRICKE, Abdrucklöffel	110-111

E	SEITE
Elektroden	108-109
Elevatoren	88
Sinus Lift	128-129
Endodontie Instrumente	35-37
Exkavatoren	21-23
F	
Fadenstopfer	29
FAHNENSTOCK, Wachsmesser	150
FARABEUF, Wundhaken	82
Feilen, Knochen-	89
Parodontal	51
Filter f. Sterilisationscontainer	137
Flachzangen	142
FLOHR, Wurzelheber	72
FRAHM, Modellierinstrumente	28
FRAZIER, Saugkanülen	91
FREER, Elevator	88
FRIEDMANN, Hohlmeißelzange	106
Füllungsentferner	29
Füllungsinstrumente	14-20, 24
Furkationssonde	10
G	
GILLIES, chirurgische Pinzette	95
Gingivalrandschräger	29
Gingivektomie Messer	50
Gips -Messer	150
-Spatel	150
GLICK, Exkavator	21
Wurzelkanalstopfer	36
GICKMANN, Raspatorium	53, 87, 131
GOLDMAN-FOX, Gingivektomie Messer	50
Raspatorium	53, 87
Parodontometer	10-11
Zahnfleissschere	96
GOSLEE, Flachzange	142
GRACEY, Küretten	40-43, 48-49
Granulat Stopfer	116
Griffe, Spiegel-	9
Skalpell-	90
GRITMAN, Gipsmesser	150
GROSS-MAIER, Kornzange	105
H	
HALSTEAD-MOSQUITO, Arterienklemme	104
Hammer	86
HARTMANN, Hohlmeißelzangen	107
HEIDBRINK, Wurzelheber	76
HEIDEMANN Spatel	27
HEMINGWAY, scharfe Löffel	89
HIRSCHFELD, Parodontalfeilen	51
Hohlmeißelzangen	106-107
HOLLENBACK, Füllungsinstrumente	19
Modellierinstrumente	28
HOPSON, Füllungsinstrument	15
HOWARTH, Elevator	88
HYGIENIST, Scaler	44
HYLIN, Wurzelheber	75
I	
Instrumenten Öl	99
Instrumenten-Trays	138-141
INTERPROXIMAL, Modellierinstrument	28
IRIS, Zahnfleissschere	96
IVORY, Kofferdamzange	34
IWANSON, Tasterzirkel	148

J	SEITE
JOSEPH, Zahnfleissschere	97
K	
KELLY, Arterienklemme	105
Zahnfleissschere	96
KIRKLAND, Gingivektomie Messer	50
Kinderzahnzangen	62-64, 70
Klammernzange	34
KLEIN, Kinderzahnzangen	64
Klemmen, -Arterien	104-105
Tuch-	105
Knochenfeilen	89
Knochenapplikatoren	115
Knochenmessinstrumente	122-123
Knochenmühle	117
Knochenschaber	114
Knochenspreizer	126
Knochenstopfer	114, 116
Knochenzangen	118
KOCHER-LANGENBECK, Wundhaken	85
Kofferdam-Instrumente	31-34
Kofferdam-Klammern	32-33
Kornzange	105
Kronen, -abnehmezange	144-145
-aufbieger	145
-entferner	145
-scheren	98
Küretten	40-43, 46, 48-49
Sinus Lift	124-125
Titan-	54, 119
L	
LaGRANGE, Zahnfleisch-Schere	96
LANGENBECK, Wundhaken	85
LANGER, Küretten	46
LeCRON, Modellierinstrument	148
LICHTENBERG, Nadelhalter	102
Ligaturschere	97
LINDO LEVIAN, Luxatoren	75
Lippenhalter	83
Lochzange, Kofferdam	34
LOCKLIN, Zahnfleissschere	98
Löffel, scharfe	89
LONDON-COLLEGE, Zahnpinzette	12
LUCAS, scharfer Löffel	89
LUER, Hohlmeißelzange	106
LUNIATSCHEK, Tamponstopfer	29
Luxatoren	78-79, 133
M	
MATHIEU, Nadelhalter	101
Matrizenspanner	36
MAYO-HEGAR, Nadelhalter	101
MAZOUCH, Kronenaufbieger	145
McCALL, Küretten	46
McINDOE, anatomische Pinzette	93
Meißel, Knochen-	127
Parodontal-	50, 131
Membran Platzierinstrument	131
MERIAM, Zahnpinzette	12
Messer, Gingivektomie-	50
Parodontal-	50
Wachs-	150
Messsonden	10-11
Messzirkel	123, 148
METZENBAUM, Präparierschere	98

M	SEITE
MICRO-MOSQUITO, Arterienklemme	104
MIDDELDORPF, Wangenhalter	84
Mikro Nadelhalter	100, 134-135
Mikro Pinzette	95, 134-135
Mikro Schere	97, 134-135
MILLER, Artikulationspinzette	12
Knochenfeilen	89
MINNESOTA, Wangenhalter	82, 120
MITCHEL, Zahnreiniger	47
Modellierinstrumente	28, 147-148
MOLT, Raspatorium	53, 87
Mundsperrer	83
MORTENSON, Füllungsinstrument	19, 24
Mund -haken	82-83, 120
-sperrer	83
-spiegel	8
-spiegelgriffe	9
N	
NABERS, Parodontometer	10
Nadelhalter	100-102, 134-135
Nahtpinzette	12, 35
NYSTROEM, Modellierinstrument	29
O	
OBWEGESER, Progeniehaken	85, 121
Ramushaken	84, 121
Raspatorium	88
OCHSENBEIN, Parodontalmeißel	50, 89
OLSEN-HEGAR, Nadelhalter	101
ORBAN, Gingivektomie Messer	50
Meißel	131
Osteotome	127
P	
Papillen Elevator	131
Parallel Bohrhilfe	122
Parodontalfeilen	51
Parodontalmeißel	50
Parodontalmesser	50
Parodontometer	10-11
PEESO, Drahtbiegezange	142
Periotome	132
PERRY, Zahnpinzette	12
Pinzette, anatomisch	92-93
Artikulations-	12
chirurgisch	94-95
Endodontie	35
Naht-	12, 35
Zahn-	12
PK THOMAS, Modellierinstrumente	147
PLANATOR, Füllungsinstrument	17
Platzierinstrument	15, 131
Polierinstrumente	19-20, 24
POTTS-SMITH, Pinzette	92, 94
Präparierschere	98
PRICHARD, Raspatorium	53, 87
PROVIDENCE-HOSPITAL, Arterienklemme	105
Provisorien Abnehmezagen	145
R	
Ramushaken	84
Raspatorien	53, 87-88, 131
REINWALD, Häkchen	47
RHODES BACK-ACTION, Meißel	50, 131
RICHTER, Abdampfnetz	149
ROGHE, Gipsspatel	150

S	SEITE
Saugkanülen	91, 115
Scaler	44-45, 47
Scharfe Löffel	89
Scheren,	96-98
Draht-	98
Kronen-	98
Ligatur-	97
Mikro-	97, 134-135
Präparier-	97
Titan-	135
Universal-	98
Zahnfleisch-	96-98
SCHLUGER, Parodontalfeile	51
Schwammzange	105
SELDIN, Raspatorium	88
SEMKEN, Pinzetten	92, 94
Sinus Lift, Elevatoren	128-129
Küretten	124-125
Skalpellgriffe	90
SMITH-RAMUS, Knochenzange	118
Sonden, Zahn-	6, 7
Parodontal-	10-11
Sondenspitzen	8
Spatel, Gips-	150
Zement-	26, 146
SPENCER, Ligaturschere	97
Spiegel, -griffe,	9
Mund-	8
Spritzen	81
Sterilisationscontainer	137
STERNBERG, Lippenhalter	83
STIEGLITZ, Wurzelsplitterzange	71
STOKE, Kofferdam-Klammernzange	34
Stopfer, Knochen-	116
Tampon-	29
Strabismuschere	96
SUGARMAN, Parodontalfeile	51

T	SEITE
Tamponstopfer	29
Taschenmesssonden	10-11
Tastzirkel	148
TAYLOR, Kürette	44
Teleskopkronenzangen	143
Titan Küretten	54, 119
TOFFLEMIRE, Matrizenspanner	36
Trays	138-141
Tuchklemmen	105
TUFFIER, Zungenspatel	82
Tunnelierinstrument	52

U	SEITE
Universal -biegezange	143
-schere	98
-scaler	41, 45, 48

V	SEITE
Vestibulumhaken	83

W	SEITE
Wachsmesser	150
WAGNER, Zahnfleissschere	97
WALDSACHS, Universalbiegezange	143
Wangenhalter	82
WARD, Modellierinstrument	28
WARWICK-JAMES, Wurzelheber	74
Wasch-Trays	138-141

W	SEITE
WESTCOTT, Polierinstrumente	19, 24
WHITE, Polierinstrumente	20
WHO Parodontalsonde	11
WIEDER, Mundhaken	82
WILAND, Modellierinstrument	28
WILLIAMS, Parodontometer	10-11
WILLIGER, Elevatorium	88
Raspatorien	88
WINTER, Wurzelheber	80
WITZEL, Wurzelzange	71
Wundhaken	82-85, 120-121
Wurzelheber	72-80
Wurzelkanalinstrumente	35-36
Wurzelspitzenheber	76
Wurzelsplitterzange	71

Z	SEITE
ZAHLE, Modellierinstrument	148
Zahnfleissscheren	96-98
Zahn -pinzetten,	12
-sonden	6-7
-sondenspitzen	8
-zangen, amerikanisch	68-70
englisch	56-67
Kinder-	62-64, 70
Zangen, Drahtbiege-	142-143
Extraktions-	56-70
Flach-	142
Hohlmeißel-	106-107
Kinderzahn-	62-64, 70
Knochen-	118
Kofferdam-	34
Teleskop-	143
Wurzelsplitter-	71
Zementspatel	26, 146
Zungenhalter	82

ART.-NR.	PAGE/SEITE	ART.-NR.	PAGE/SEITE	ART.-NR.	PAGE/SEITE	ART.-NR.	PAGE/SEITE
100/...	6	180/5	12	200/8	8	335/GF14-ED	
101/...	6	180/5D	12	201/10 – 30	8		53, 87, 131
101/16	36	180/6	12	210/1 – 2	98	335/H	88
102/...	6	180/68	12, 35	215/1	148	335/M10-ED	53, 87
104/...	8	180/8 – 9	12	215/4	148	335/M9	53, 87
103/..	6	181/4	12, 35	215/6 – 8	123	335/M9-ED	53, 87
105/...	7	182/..	92-93	217/4	97	335/MPI	131
107/...	7	183/...	94-95	218/4	97	335/P4 – P6-ED	132
108/...	36	184/20	95, 134	220/1	96	335/PH1	131
110/...	14-15	184/20T	135	220/1SC	96	335/PR3S	53, 87
110/CHP	14	184/21	95, 134	220/2	96	335/S23	88
111/...	16	184/24	95, 134	220/2SC	96	335/T...	52
112/...	16	184/24T	135	229/1 – 4	98	336/11	89
113/...	17	184/25	95, 134	230/1	97	336/11-ED	89
114/...	18	184/41	35	230/2	97	336/22	89
115/..	17	184/42	35	235/3	97	336/22-ED	89
116/..	27	184/43	35	235/4	97	336/5	88
117/1	29	184/44	35	236/2	98	337/1	88
118/B1	36	185/...	90	240/1	96	337/71 – 74	88
118/B2	36	190/1 – 4	72	240/1SC	96	338/3 – 5	89
118/GL1	36	190/13 – 14	73	240/2	96	353/1 – 3	84
118/S..	35	190/15 – 17	74	240/2SC	96	353/12	85, 121
119/1	144	190/22 – 24	75	242/3	98	353/20	85, 121
119/2	144	190/31 – 34	75	245/1	96	353/21	85, 121
119/22	145	190/25C	79	245/1SC	96	353/5	82, 121
119/3	145	190/25ST	79	250/0	96	353/7	82, 121
119/3A-C	145	190/3C	79	250/OSC	96	353/8	82
119/6	145	190/3C-ED	78, 133	250/1	96	353/9	82
121/C	47	190/3CF	79	250/1SC	96	354/6	82, 121
121/C-ED	47	190/3ST	79	250/20 – 22	97	354/7	82
121/M	47	190/3ST-ED	78, 133	250/5	98	354/8	82
122/..ED	6	190/3STF	79	250/5TC	98	354/W1	82
123/..ED	7	190/45C-ED	78, 133	251/31-34	97, 134	354/W2	82
130/1-3	89	190/45ST-ED	78, 133	251/31T – 34T	135	355/11 – 15	85
134/...	21-23	190/4C	79	255/...	143	370/...	81
135/...	21-23	190/4C-ED	78, 133	270/...	150	371/...	81
136/...	106-107	190/4CF	79	275/...	150		
137/1	107	190/4ST	79	280/1 – 3	148	400/...	42-43
140/..	26, 146	190/4ST-ED	78, 133	290/1 – 2	104	400/..ED	42-43
145/..	30	190/4STF	79	290/11 – 12	104	400/...TIN	48
150/...	19, 20	190/5C	79	290/14 – 15	104	401/..TIN	48-49
152/...	19	190/5CF	79	290/31 – 32	105	401/13 – 14	46
160/..	28	190/5ST	79	290/35 – 36	105	401/13S – 14S	46
161/3	19	190/5STF	79	291/...	104	401/17S – 18S	46
161/4	19	190/6 – 7	72	296/11	105	401/204-ED	45
161/H...	28	190/B50 – B51	73	298/31	105	401/204S	45
161/W	28	190/L1C-ED	78, 133	298/32	105	401/204S-ED	45
162/0	19	190/L1ST-ED	78, 133			401/204SD	45
162/1	28	190/L2C-ED	78, 133	300/...	108, 109	401/204SD-ED	45
162/3-6	28	190/L2ST-ED	78, 133	301/...	108, 109	401/204SDT-ED	54, 119
162/78	28	191/...	80	315/1 – 5	34	401/2RL	45
162/7A	29	192/01 – 03	76	316/RDC..	32, 33	401/2RL-ED	45
162/J2	28	192/04 – 06	76	316/SET	31	401/2RL-T-ED	54, 119
165/3	19	192/1 – 3	74	320/...	30	401/4RL	45
165/3-ED	19	192/11 – 13	76	330/1	86	401/4RL-ED	45
166/1 – 5	147	193/301 – 303	73	330/3	86	401/4RLT-ED	54, 119
170/1	29	195/...	91	332/41	89	401/C1 +C2	116
173/2	29			332/42	89	401/C13 – 14	45
173/28 – 29	29	200/06	8	335/06	88	401/C13-14-ED	45
173/28 – 29R	29	200/08	8	335/2	116	401/C103	44
173/4 – 7	29	200/1 – 5	9	335/24GSP	53, 87, 131	401/CK6	44
174/...	100, 134	200/11	8	335/24GSP-ED		401/CK6-ED	44
174/80T – 83T	135	200/12	8		53, 87, 131	401/FS...	51
175/...	101-102	200/51	9	335/B1	53, 87, 131	401/H3 – 7	51
180/1	12	200/51M	9	335/B1-ED	53, 87, 131	401/H5 – 11	51
180/10	12	200/6	8	335/GF14	53, 87, 131	401/H5 – 33	44

ART.-NR.	PAGE/SEITE
401/H5-33-ED	44
401/H6-H7	44
401/H6-H7-ED	44
401/H6H7T-ED	54, 119
401/K1	50
401/KGF...	50
401/KO12	50, 131
401/L...	46
401/L...-ED	46
401/L1-2T-ED	54, 119
401/L3-4T-ED	54, 119
401/L5-6T-ED	54, 119
401/M23	46
401/M23-ED	46
401/O4	50
401/RBA	50, 131
401/U15 - 30	44
404/..ED	40, 41
405/23W	10
405/2N	10
405/2NC-V	10
405/CP..	11
405/PGF	11
405/PGFW	10
405/W	11
405/W-ED	11
405/WHO	11
405/WHO-ED	11
<hr/>	
500/..	138-141
510/..	137
511/..	137
512/..	137
513/..	137
514/..	137
515/..	137
516/..	137
<hr/>	
600/1	56
600/13	59
600/13S	63
600/17	57
600/18	57
600/2	56
600/22	59
600/22S	63
600/29	58
600/29S	62
600/30	58
600/33	59
600/33A	59
600/33S	63
600/34	61
600/35	61
600/36	61
600/37	62
600/39	62
600/39L	62
600/39R	62
600/4	59
600/46L	61
600/51	58
600/51A	58
600/51S	62
600/67	57
600/67A	57

ART.-NR.	PAGE/SEITE
600/7	56
600/73	59
600/74	61
600/74N	61
600/75	59
600/76	58
600/76N	58
600/79	60
600/79A	60
600/86A	60
600/86C	60
600/89	57
600/90	57
600/99	60
600/99-1-4	60
600/PEDO-SET	63
600/SET	65
602/10S	68
602/10SD	68
602/150	69
602/150D	69
602/150S	70
602/151	69
602/151D	69
602/151S	70
602/17	69
602/17D	69
602/23	69
602/23D	69
602/88L	68
602/88R	68
603/13	67
603/2	66
603/33	67
603/34	66
603/35	66
603/36	67
603/67	66
603/7	66
603/74N	67
603/79	66
604/13	59
604/13S	63
604/17	57
604/18	57
604/2	56
604/22	59
604/22S	63
604/29	58
604/29S	62
604/33	59
604/33	63
604/37	62
604/39	62
604/4	59
604/51A	58
604/51S	62
604/67	57
604/7	56
604/74N	61
604/79	60
604/86A	60
604/PEDO-SET	63
605/...	64
610/...	71
610/5	35, 71

ART.-NR.	PAGE/SEITE
630/..	142
631/..	143
<hr/>	
700/2	83, 120
700/2K	83
700/3	83
700/6	83, 120
700/7	83
700/8	83
720/...	110-111
<hr/>	
800/1 + 1A	114
800/2 + 2A	114
800/5	122
800/51	122
800/51-25	122
801/A	118
801/S	118
802/A	118
806/1 - 3	115
806/20 - 21	115
810/SL...	124
811/SL1F - SL4F	125
811/SL5F - SL6F	114
812/..	127
816/..	126
817/..	126
840/..	128
841/..	128
842/..	128
843/..	128
844/..	128
845/..	128
848/..	129
849/..	129
851/..	129
852/..	129
<hr/>	
900/2	149
900/2A	149
900/5	117
900/6	117
900/HTO7	99
<hr/>	
C110/..	24-25
C114/..	24-25
C150/..	24-25
C162/0	24-25
C165/3	24-25
<hr/>	
P600/1	56
P600/13	59
P600/17	57
P600/18	57
P600/2	56
P600/22	59
P600/29	58
P600/30	58
P600/33	59
P600/33A	59
P600/4	59
P600/46L	61
P600/51	58
P600/51A	58
P600/67A	57
P600/7	56

ART.-NR.	PAGE/SEITE
P600/73	59
P600/74	61
P600/74N	61
P600/75	59
P600/79	60
P600/86A	60
P600/89	57
P600/90	57
P600/SET	65

IMPLANTOLOG
IMF
DIAGNOSTICS ORTHOD
DIAGNOSTIK KIEFERORTHOPÄD
CONSERVATIV
KONSERVIERENDE BEHANDL
PERIO
PARODONTOLO
EXTRACTION DENTAL S
EXTRAKTION DENTA
IMPRESSION TRAYS DENTAL ELECT
ABDRUCKLÖFFEL DENTALEL
STORAGE & STERILIZAT
AUFBEWAHRUNG &
PROTHETIK PROSTHETICS



FON: +49 (0) 7463-7232

FAX: +49 (0) 7463-222

info@leibinger-dental.de

www.leibinger-dental.de